

为您的产品保驾护航

PRODUCT DATASHEET

Surface Mount PTC Devices

## ASMD0805 Series Surface Mount PTC Devices

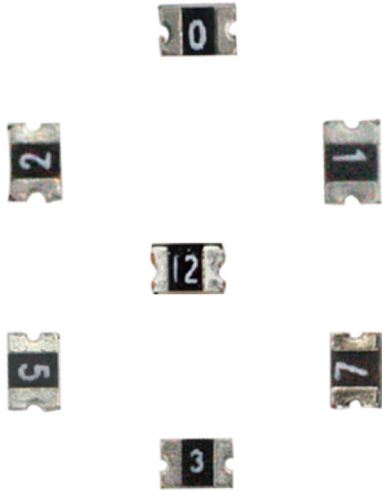

### Description

The ASMD0805 series provides miniature surface mount resettable overcurrent protection with holding current from 50mA to 1.5A.

This series is suitable for ultra portable applications where space is at a premium and the device current is low.



### Features



- RoHS compliant and lead-free
- Low profile
- Halogen-free
- Fast response to fault current
- Compact design saves board space
- Compatible with high temperature solders

### Applications

- Mobile phones and PDAs
- IC VCC protection
- Portable MP3 and media player
- Set-top-box and HDMI
- Mobile Internet Device (MID)
- Game console port protection
- USB peripherals

### Agency Approvals

Agency	File Number
	pending
	pending

Regulation	Standard
	2002/95/EC
	EN14582

**Performance Specification**

Model	V <sub>max</sub> (V dc)	I <sub>max</sub> (A)	I <sub>hold</sub> @25°C (A)	I <sub>trip</sub> @25°C (A)	P <sub>d</sub> Typ. (W)	Maximum Time To Trip		Resistance	
						Current (A)	Time (Sec)	R <sub>i min</sub> (Ω)	R <sub>1max</sub> (Ω)
ASMD0805-005	15.0	100	0.05	0.15	0.5	0.5	1.50	1.500	20.0
ASMD0805-010	15.0	100	0.10	0.30	0.5	0.5	1.50	0.750	6.00
ASMD0805-010-30V	30.0	100	0.10	0.30	0.5	0.5	1.50	0.750	6.00
ASMD0805-020	9.0	100	0.20	0.50	0.5	8.0	0.02	0.500	3.500
ASMD0805-035	6.0	100	0.35	0.75	0.5	8.0	0.10	0.200	1.200
ASMD0805-035-12V	12.0	100	0.35	0.75	0.5	8.0	0.10	0.200	1.200
ASMD0805-050	6.0	100	0.50	1.00	0.5	8.0	0.10	0.100	0.850
ASMD0805-050-12V	12.0	100	0.50	1.00	0.5	8.0	0.10	0.100	0.850
ASMD0805-050-16V	16.0	100	0.50	1.00	0.5	8.0	0.10	0.100	0.850
ASMD0805-050-24V	24.0	100	0.50	1.00	0.5	8.0	0.10	0.100	0.850
ASMD0805-075	6.0	40	0.75	1.50	0.6	8.0	0.20	0.070	0.385
ASMD0805-075-12V	12	40	0.75	1.50	0.6	8.0	0.20	0.070	0.385
ASMD0805-100	6.0	100	1.00	1.95	0.6	8.0	0.30	0.040	0.230
ASMD0805-100-12	12.0	100	1.00	1.95	0.6	8.0	0.30	0.040	0.230
ASMD0805-110	6.0	100	1.10	2.20	0.6	8.0	0.30	0.035	0.210
ASMD0805-110-12V	12.0	100	1.10	2.20	0.6	8.0	0.30	0.035	0.210
ASMD0805-125	6.0	100	1.25	2.50	1.5	8.0	0.60	0.025	0.140
ASMD0805-150	6.0	100	1.50	3.00	1.0	8.0	0.50	0.015	0.130

I<sub>hold</sub> = Hold Current. Maximum current device will not trip in 25°C still air.

I<sub>trip</sub> = Trip Current. Minimum current at which the device will always trip in 25°C still air.

V<sub>max</sub> = Maximum operating voltage device can withstand without damage at rated current (I<sub>max</sub>).

I<sub>max</sub> = Maximum fault current device can withstand without damage at rated voltage (V<sub>max</sub>).

P<sub>d</sub> = Power dissipation when device is in the tripped state in 25°C still air environment at rated voltage.

R<sub>i min/max</sub> = Minimum/Maximum device resistance prior to tripping at 25°C.

R<sub>1max</sub> = Maximum device resistance is measured one hour post reflow.

CAUTION : Operation beyond the specified ratings may result in damage and possible arcing and flame.

**Environmental Specifications**

Test	Conditions	Resistance change
Passive aging	+85°C, 1000 hrs.	±5% typical
Humidity aging	+85°C, 85% R.H. , 168 hours	±5% typical
Thermal shock	+85°C to -40°C, 20 times	±33% typical
Resistance to solvent	MIL-STD-202,Method 215	No change
Vibration	MIL-STD-202,Method 201	No change
Ambient operating conditions : - 40 °C to +85 °C		
Maximum surface temperature of the device in the tripped state is 125 °C		

## Thermal Derating Curve

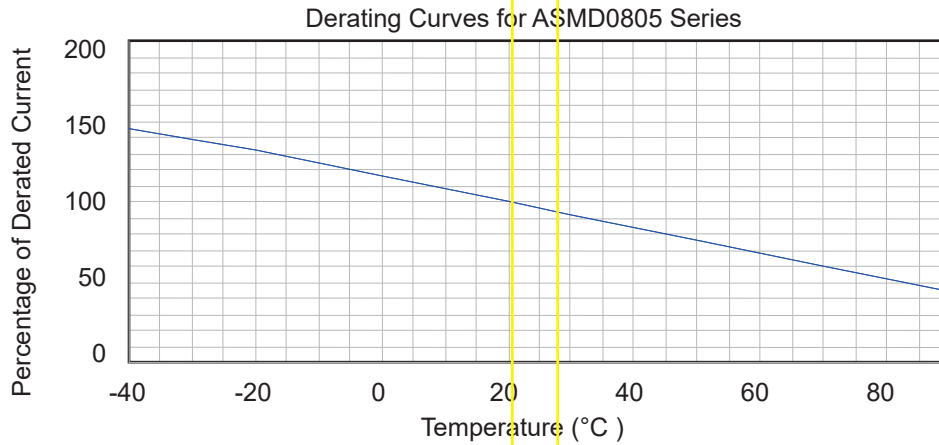

## Average Time-Current Curve

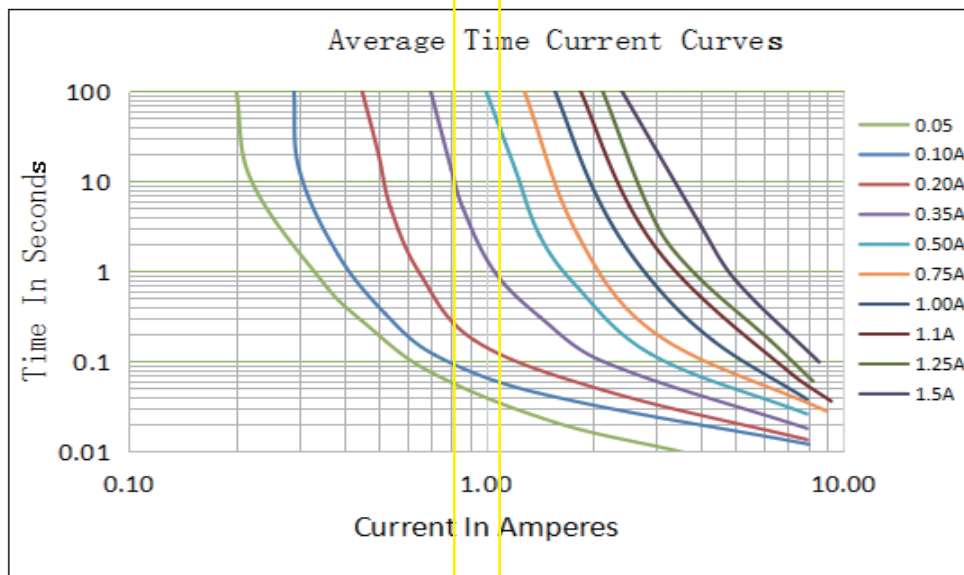

## Thermal Derating Chart

Model	Maximum ambient operating temperature (T <sub>mao</sub> ) vs. hold current (I <sub>hold</sub> )								
	- 40°C	- 20°C	0°C	25°C	40°C	50°C	60°C	70°C	85°C
ASMD0805-005	0.070	0.060	0.055	0.050	0.040	0.035	0.030	0.025	0.015
ASMD0805-010	0.14	0.12	0.11	0.10	0.08	0.07	0.06	0.05	0.03
ASMD0805-020	0.28	0.25	0.23	0.20	0.17	0.14	0.12	0.10	0.07
ASMD0805-035	0.47	0.44	0.39	0.35	0.30	0.27	0.24	0.20	0.14
ASMD0805-050	0.68	0.62	0.55	0.50	0.40	0.37	0.33	0.29	0.23
ASMD0805-075	1.00	0.90	0.79	0.75	0.63	0.57	0.53	0.41	0.34
ASMD0805-100	1.35	1.25	1.15	1.00	0.82	0.74	0.65	0.55	0.42
ASMD0805-110	1.45	1.35	1.20	1.10	0.92	0.84	0.75	0.65	0.52
ASMD0805-125	1.65	1.53	1.36	1.25	1.05	0.95	0.85	0.74	0.59
ASMD0805-150	1.98	1.84	1.63	1.50	1.26	1.14	1.02	0.88	0.71

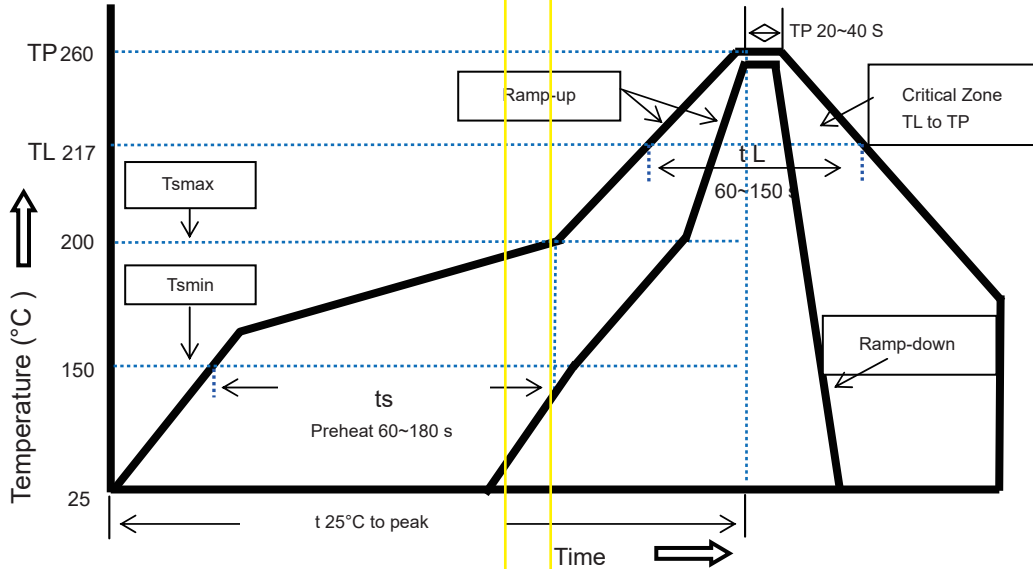
**Soldering Parameters**

Profile Feature	Pb-Free Assembly
Average Ramp-Up Rate (Ts max to T p)	3 °C/second max.
Preheat	
-Temperature Min(Ts min)	150 °C
-Temperature Max(Ts max)	200 °C
-Time(Ts min to Ts max)	60~180 seconds
Time maintained above:	
-Temperature(TL)	217 °C
-Time(tL)	60~150 seconds
Peak Temperature(Tp)	260 °C
Ramp-Down Rate	6 °C/second max.
Time 25 °C to Peak Temperature	8 minutes max
Storage Condition	0 °C~35 °C, ≤70%RH

Recommended reflow methods: IR, vapor phase oven, hot air oven, N2 environment for lead-free

Recommended maximum paste thickness is 0.25mm

Devices can be cleaned using standard industry methods and solvents.

Note 1: All temperature refer to topside of the package, measured on the package body surface.

Note 2: If reflow temperatures exceed the recommended profile, devices may not meet the performance requirements.

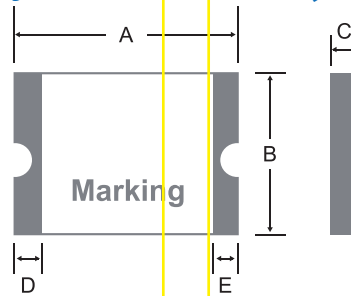
**Physical Dimensions(mm.)**

Model	A		B		C		D	E
	Min.	Max.	Min.	Max.	Min.	Max.	Min.	Min.
ASMD0805-005	2.00	2.20	1.20	1.50	0.40	0.90	0.20	0.10
ASMD0805-010	2.00	2.20	1.20	1.50	0.40	0.90	0.20	0.10
ASMD0805-010-30V	2.00	2.20	1.20	1.50	0.40	0.90	0.20	0.10
ASMD0805-020	2.00	2.20	1.20	1.50	0.35	0.80	0.20	0.10
ASMD0805-035	2.00	2.20	1.20	1.50	0.35	0.80	0.20	0.10
ASMD0805-035-12V	2.00	2.20	1.20	1.50	0.35	0.80	0.20	0.10
ASMD0805-050	2.00	2.20	1.20	1.50	0.35	0.80	0.20	0.10
ASMD0805-050-12V	2.00	2.20	1.20	1.50	0.35	0.80	0.20	0.10
ASMD0805-050-16V	2.00	2.20	1.20	1.50	0.50	1.10	0.20	0.10
ASMD0805-050-24V	2.00	2.20	1.20	1.50	0.50	1.10	0.20	0.10
ASMD0805-075	2.00	2.20	1.20	1.50	0.50	1.00	0.20	0.10
ASMD0805-075-12V	2.00	2.20	1.20	1.50	0.50	1.00	0.20	0.10
ASMD0805-100	2.00	2.20	1.20	1.50	0.70	1.20	0.20	0.10
ASMD0805-100-12V	2.00	2.20	1.20	1.50	0.70	1.20	0.20	0.10
ASMD0805-110	2.00	2.20	1.20	1.50	0.70	1.20	0.20	0.10
ASMD0805-110-12V	2.00	2.20	1.20	1.50	0.70	1.20	0.20	0.10
ASMD0805-125	2.00	2.20	1.20	1.50	1.00	1.50	0.20	0.10
ASMD0805-150	2.00	2.20	1.20	1.50	1.00	1.50	0.20	0.10

**Termination Pad Characteristics**

Terminal pad materials: Tin-plated Nickel-Copper

Terminal pad solder ability: Meets EIA specification RS186-9E and ANSI/J-STD-002 Category 3

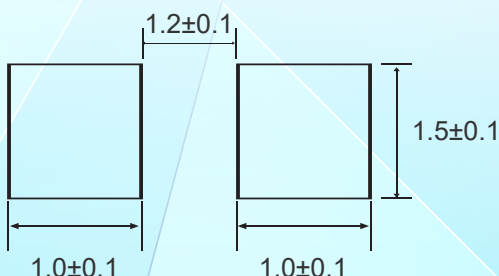
**Packaging Quantity and Marking**

Part Number	Quantity
ASMD0805-005.010.020.035.050.	5,000 pcs/reel
ASMD0805-075.100.110.125.	4,000 pcs/reel
ASMD0805-150	3,500 pcs/reel

Tape &amp; reel packaging per EIA481-1

## Tape And Reel Specifications (mm)

Governing Specifications	EIA 481-1
W	8.0 ± 0.3
P0	4.0 ± 0.10
P1	4.0 ± 0.10
P2	2.0 ± 0.05
A0	1.45 ± 0.10
B0	2.30 ± 0.10
B1max.	4.35
D0	1.55 + 0.1, -0
F	3.5 ± 0.05
E1	1.75 ± 0.10
E2min.	6.25
T	0.25
T1max.	0.1
K0	0.74 ± 0.1
Leader min.	390
Trailer min.	160
Reel Dimensions	
A max.	178
N min.	60
W1	9.0 ± 0.5
W2	12.0 ± 0.05

### Storage And Handling

- Storage conditions: 40°C max, 70% R.H.
- Devices may not meet specified performance if storage conditions are exceeded. Technology Corp.

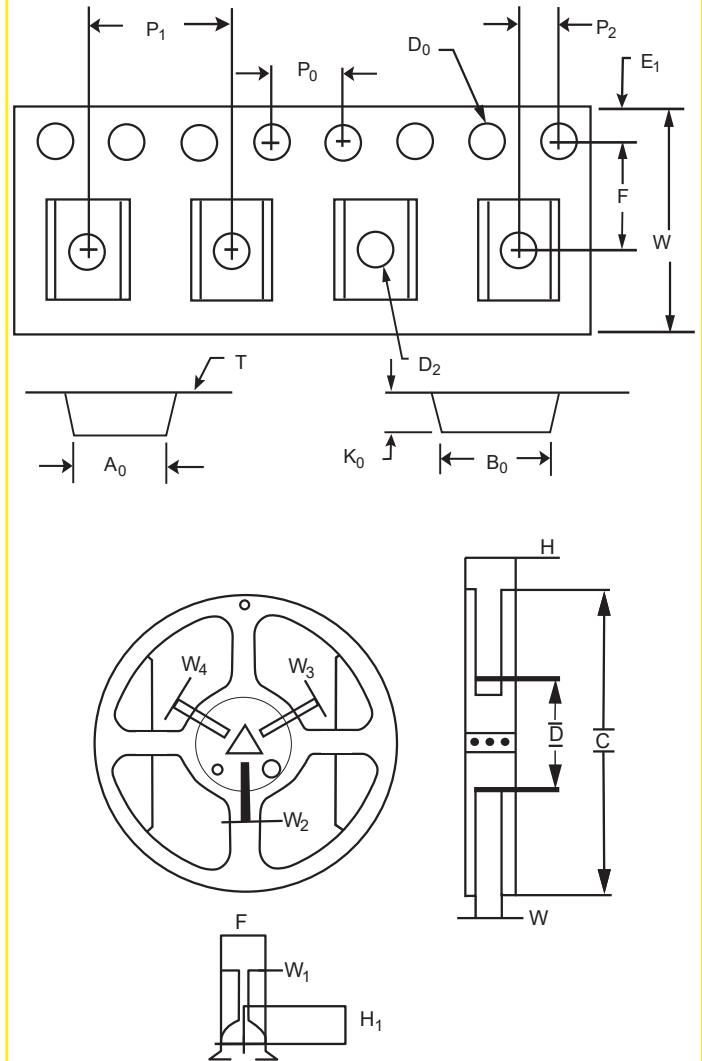

**Part Number System**
**ASMD 0805 - □□□ - □□**

Special Voltage Rating(Optional)

Holding Current Rating

 Device Dimensions:  
 Length/width(Unit:1/100 inch) Size 2012 mm / 0805 inch

Surface Mount Device

**Cross Reference**

Model	Cross Reference		
	Tyco / PolySwitch®	Littelfuse / POLY-FUSE®	Polytronics / EVERFUSE®
ASMD0805-010	-	0805L010	SMD0805P010TF
ASMD0805-020	-	0805L020	SMD0805P020TF
ASMD0805-035	picoSMDC035F	0805L035	SMD0805P035TF
ASMD0805-050	-	0805L050	SMD0805P050TF
ASMD0805-075	-	0805L075	SMD0805P075TF
ASMD0805-100	-	0805L100	SMD0805P100TF
ASMD0805-100-12	-	0805L100/12	SMD0805P100TF/12
ASMD0805-110	-	0805L110	SMD0805P110TF
ASMD0805-125	-	-	-

"PolySwitch" is a registered trademark of Tyco Electronics.

"POLY-FUSE" is a registered trademark of Littelfuse, Inc.

"EVERFUSE" is a registered trademark of Polytronics Technology Corp.



## X-ON Electronics

Largest Supplier of Electrical and Electronic Components

*Click to view similar products for [Resettable Fuses - PPTC category](#):*

*Click to view products by [JDT manufacturer](#):*

Other Similar products are found below :

[RF0077-000](#) [RF2534-000](#) [RF3256-000](#) [RF3281-000](#) [RF3301-000](#) [RF3344-000](#) [RF3382-000](#) [SMD125-2](#) [RF2171-000](#) [RF2531-000](#) [RF2873-000](#) [RF3060-000](#) [TR600-150Q-B-0.5-0.130](#) [RXE090](#) [5E4795/04-1502](#) [TRF250-080T-B-1.0-0.125](#) [SMD100-2](#) [NIS5452MT1TXG](#) [NIS5431MT1TXG](#) [SMD250-2](#) [0ZCM0001FF2G](#) [0ZCM0003FF2G](#) [0ZCM0004FF2G](#) [BK60-017-DZ-E0.6](#) [F95456-000](#) [LVR100S](#) [RS30-090](#) [RS30-600](#) [RS30-700](#) [RS30-800](#) [RS30-900](#) [RS60RB-005](#) [RS60RB-010](#) [RS60RB-020](#) [RS60RB-025](#) [RS60RB-050](#) [RS60RB-075](#) [RS60RB-160](#) [SMD1206-300C-12V](#) [SB250-145](#) [SB250-030](#) [SB250-040](#) [SB250-200](#) [SB250-600](#) [SMD0805-005-24V](#) [SMD0805-050-16V](#) [SMD1210-005-60V](#) [SMD0805-005](#) [R60-375](#) [SMD0805K110SF6V](#)