

为您的产品保驾护航

PRODUCT DATASHEET

Electro-Static Discharge

JED323-5V-LG ESD

Features

- Package: SOD-323
- 360W peak pulse power (8/20 μ s)
- Ultra low capacitance: 1pF typical
- Ultra low leakage: nA level
- Operating voltage: 5V
- Low clamping voltage
- Protects one power line or data line
- Complies with following standards:
 - IEC 61000-4-2 (ESD) immunity test
 - Air discharge: ± 30 kV
 - Contact discharge: ± 30 kV
 - IEC61000-4-5 (Lightning) 18A (8/20 μ s)
- RoHS compliant

Applications

- USB Ports
- Smart Phones
- Wireless Systems
- Ethernet 10/100/1000 Base T

Schematic Diagram

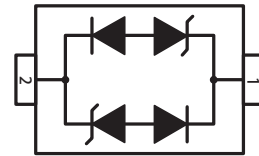

Pin Description



Limiting Values($T_A = 25^\circ\text{C}$, unless otherwise specified)

Symbol	Parameter	Conditions	Value	Unit
V_{ESD}	Electrostatic Discharge Voltage	IEC 61000-4-2;Contact Discharge	± 30	kV
		IEC 61000-4-2;Air Discharge	± 30	kV
P_{Pk}	Peak Pulse Power	$t_P=8/20\mu s$	360	W
I_{PP}	Peak Pulse Current	$t_P=8/20\mu s$	18	A
T_J	Operating Temperature Range	-	-55 to +125	$^\circ\text{C}$
T_{stg}	Storage Temperature Range	-	-55 to +150	$^\circ\text{C}$

Electrical Characteristics($T_A = 25^\circ\text{C}$, unless otherwise specified)

Symbol	Parameter	Conditions	Min	Typ.	Max	Unit
V_{RWM}	Reverse Working Voltage	$T_A=25^\circ\text{C}$	-	-	5	V
V_{BR}	Breakdown Voltage	$I_T=1\text{mA}$	6	-	-	V
I_R	Reverse Leakage Current	$V_{RWM}=5\text{V}; T_A=25^\circ\text{C}$	-	-	0.2	μA
V_C	Clamping Voltage	$I_{PP}=1\text{A}(8 \times 20\mu s \text{ pulse})$	-	-	10	V
V_C	Clamping Voltage	$I_{PP}=18\text{A}(8 \times 20\mu s \text{ pulse})$	-	-	20	V
C_J	Junction Capacitance	$V_R=0\text{V}, f=1 \text{ MHz}$	-	1	-	pF

Typical Characteristics

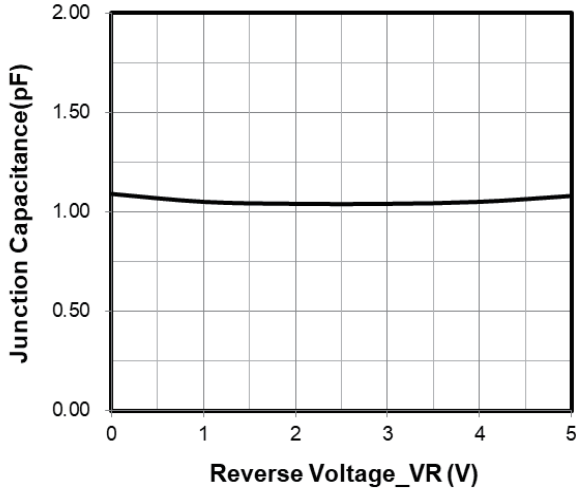

Junction Capacitance vs. Reverse Voltage

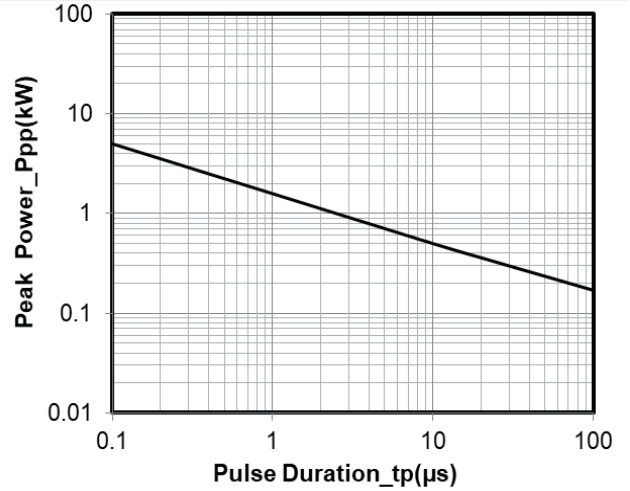

Peak Pulse Power vs. Pulse Time

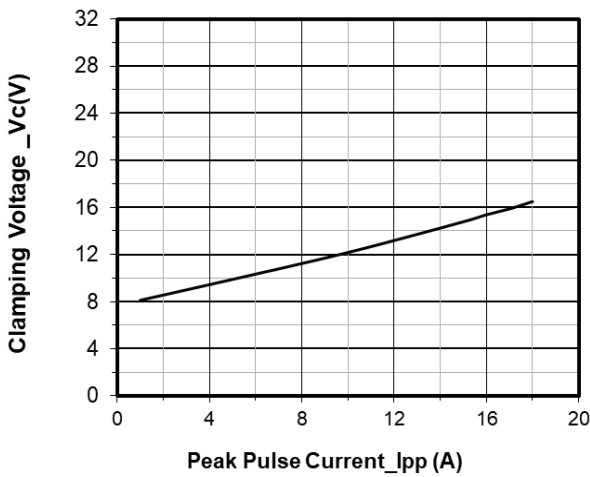

Clamping Voltage vs. Peak Pulse Current ($t_p = 8/20 \mu s$)

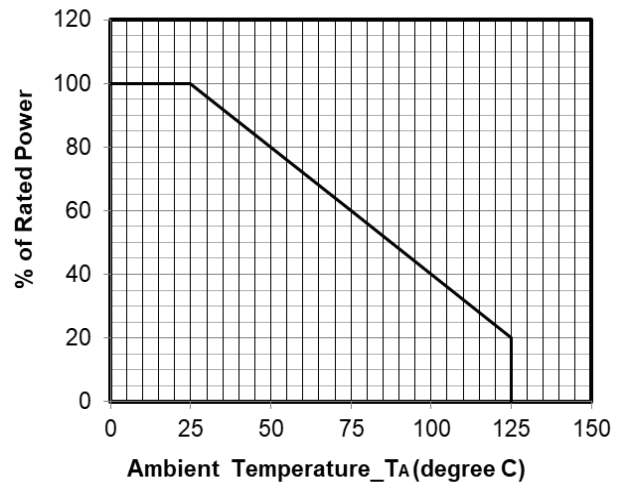

Power Derating Curve

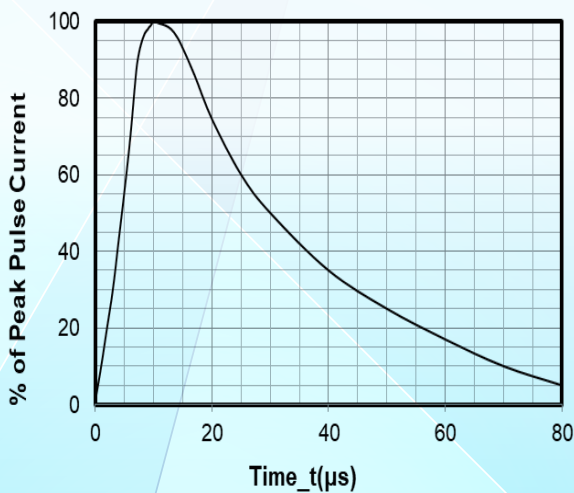

8 X 20 μs Pulse Waveform

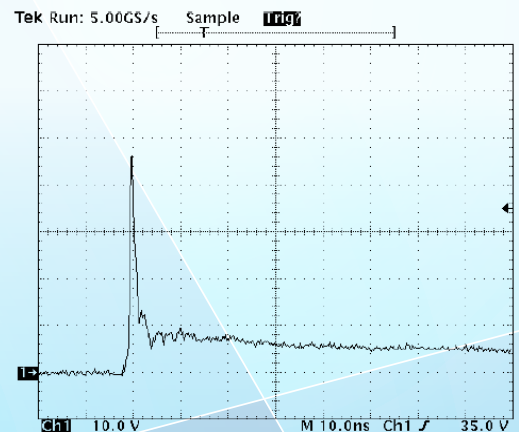

ESD Clamping Voltage
8 kV Contact per IEC61000-4-2

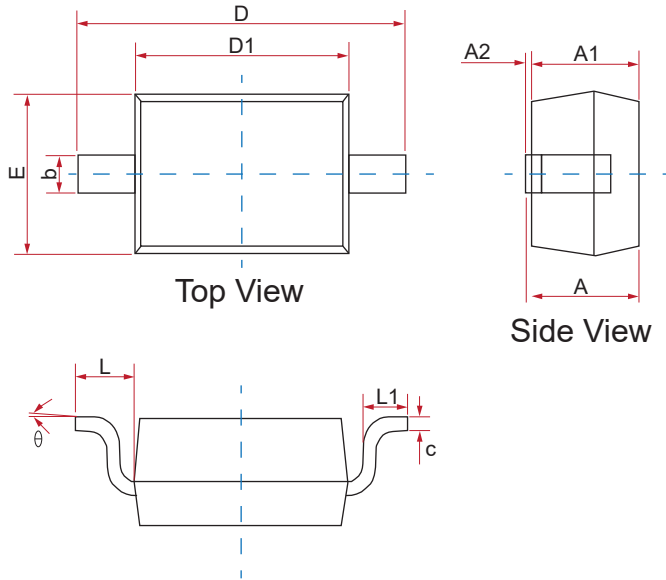
Physical Dimensions(mm.)

Symbol	Dimensions In Millimeters		
	Min	Nom	Max
A	0.800	--	1.100
A1	0.800	--	0.900
A2	0.000	--	0.100
b	0.250	--	0.400
c	0.080	--	0.177
D1	1.600	1.700	1.800
D	2.300	--	2.800
E	1.150	--	1.400
L	0.475REF		
L1	0.100	--	0.500
e	0°	--	8°

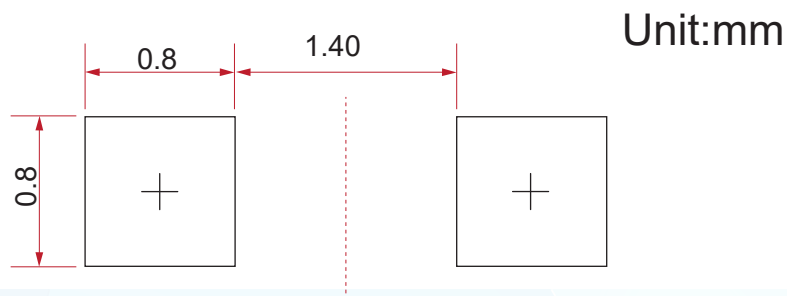
Suggested Land Pattern

Packaging Quantity

Part Number	Delivery Form	Delivery Quantity
JED323-5V-LC	7"T&R	3,000

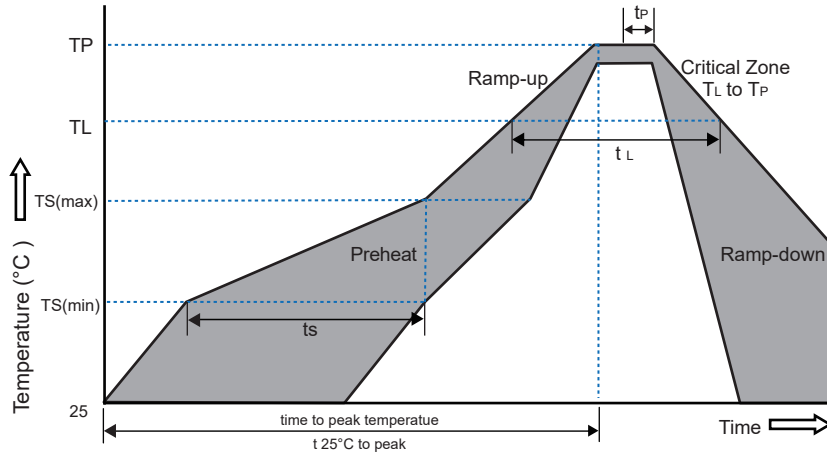
Soldering Parameters



Reflow Condition		Pb-Free Assembly
Pre-heat	-Temperature Min($T_{s(min)}$)	+150°C
	-Temperature Max($T_{s(max)}$)	+200°C
	-Time(Min to Max)(t_s)	60~180 secs.
Average ramp up rate (Liquid us Temp(T_L) to peak)		3°C/sec. Max
Ts(max) to T_L - Ramp-up Rate		3°C/sec. Max
Reflow	-Temperature(T_L)(Liquid us)	+217°C
	-Temperature (t_L)	60~150 secs.
Peak Temp (T_P)		+260(+0/-5)°C
Time within 5°C of actual Peak Temp (t_p)		30 secs. Max
Ramp-down Rate		6°C/sec. Max
xTime 25°C to Peak Temp (TP)		8 min. Max
Do not exceed		+260°C

Part Number System

JE D323 - 5V - L C

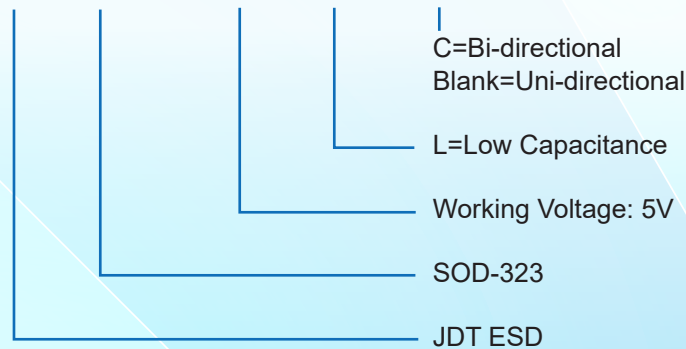

X-ON Electronics

Largest Supplier of Electrical and Electronic Components

Click to view similar products for [ESD Suppressors / TVS Diodes](#) category:

Click to view products by [JDT](#) manufacturer:

Other Similar products are found below :

[60KS200C](#) [D18V0L1B2LP-7B](#) [D5V0F4U5P5-7](#) [NTE4902](#) [P4KE27CA](#) [P6KE11CA](#) [P6KE8.2A](#) [SA60CA](#) [SA64CA](#) [SMBJ12CATR](#)
[SMBJ33CATR](#) [SMBJ6.5A](#) [SMBJ8.0A](#) [ESD101-B1-02ELS](#) [E6327](#) [ESD112-B1-02EL](#) [E6327](#) [ESD7451N2T5G](#) [19180-510](#) [CPDT-5V0USP-](#)
[HF](#) [3.0SMCJ33CA-F](#) [3.0SMCJ36A-F](#) [HSPC16701B02TP](#) [JANTX1N6126A](#) [D3V3Q1B2DLP3-7](#) [D55V0M1B2WS-7](#) [SCM1293A-04SO](#)
[ESD200-B1-CSP0201](#) [E6327](#) [SM12-7](#) [CEN955](#) [W/DATA](#) [VESD12A1A-HD1-GS08](#) [CPDQC5V0-HF](#) [D1213A-01LP4-7B](#) [ESD101-B1-02EL](#)
[E6327](#) [AOZ8808DI-03](#) [5KP15A](#) [5KP48A](#) [5KP90A](#) [ESD3V3D7-TP](#) [15KPA36A-LF](#) [P4KE56CA](#) [P4KE68A](#) [P4KE91CATR](#) [P6KE120A](#)
[P6KE13CA](#) [P6KE43CA](#) [P6KE6.8CA](#) [P6KE8.2](#) [P6SMBJ20CA](#) [JANTX1N6072A](#) [SR2835ESKG](#) [SA90CA](#)