

为您的产品保驾护航

PRODUCT DATASHEET

Electro-Static Discharge

JED323-8V-LG ESD

Features

- Package: SOD-323
- 350W peak pulse power (8/20 μ s)
- Ultra low capacitance: 1pF typical
- Ultra low leakage: nA level
- Operating voltage: 8V
- Low clamping voltage
- Protects one power line or data line
- Complies with following standards:
 - IEC 61000-4-2 (ESD) immunity test
 - Air discharge: ± 30 kV
 - Contact discharge: ± 30 kV
 - IEC61000-4-5 (Lightning) 18A (8/20 μ s)
- RoHS compliant

Applications

- USB Ports
- Smart Phones
- Handheld - Wireless Systems
- Ethernet 10/100/1000 Base T
- xDSL

Schematic Diagram

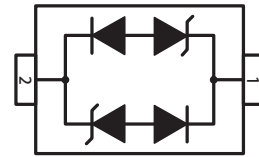

Pin Description



Limiting Values($T_A = 25\text{ }^\circ\text{C}$, unless otherwise specified)

Symbol	Parameter	Conditions	Value	Unit
V _{ESD}	Electrostatic Discharge Voltage	IEC 61000-4-2;Contact Discharge	± 30	kV
		IEC 61000-4-2;Air Discharge	± 30	kV
P _{PP}	Peak Pulse Power	t _P =8/20 μ s	350	W
I _{PP}	Peak Pulse Current	t _P =8/20 μ s	18	A
T _J	Operating Temperature Range	-	-55 to +125	$^\circ\text{C}$
T _{stg}	Storage Temperature Range	-	-55 to +150	$^\circ\text{C}$

Electrical Characteristics($T_A = 25\text{ }^\circ\text{C}$, unless otherwise specified)

Symbol	Parameter	Conditions	Min	Typ.	Max	Unit
V _{RWM}	Reverse Working Voltage	T _A =25 $^\circ\text{C}$	-	-	8	V
V _{BR}	Breakdown Voltage	I _T =1mA	8.5	-	10	V
I _R	Reverse Leakage Current	V _{RWM} =8V;T _A =25 $^\circ\text{C}$	-	-	0.2	μA
V _C	Clamping Voltage	I _{PP} =1A(8x20 μ s pulse)	-	-	9	V
V _C	Clamping Voltage	I _{PP} =18A(8x20 μ s pulse)	-	-	19.5	V
C _J	Junction Capacitance	V _R =0V,f=1 MHz	-	1	-	pF

Typical Characteristics

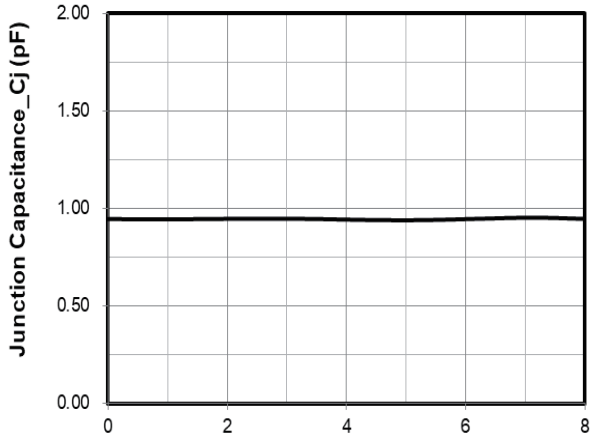

Junction Capacitance vs. Reverse Voltage

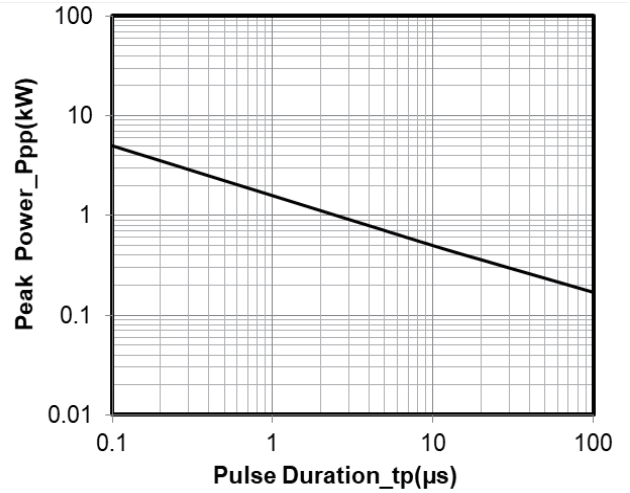

Peak Pulse Power vs. Pulse Time

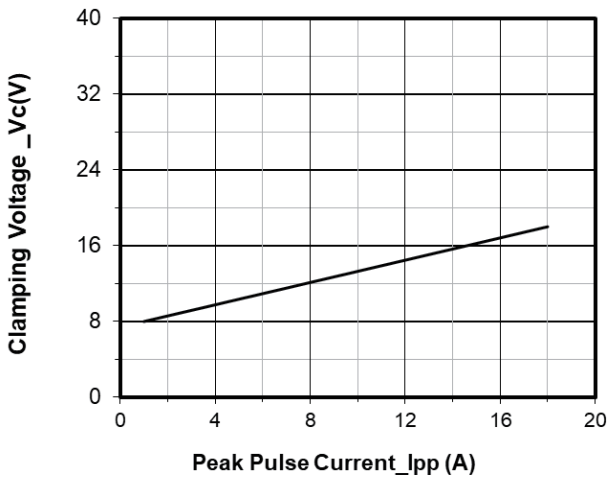

Clamping Voltage vs. Peak Pulse Current (tp = 8/20 μs)

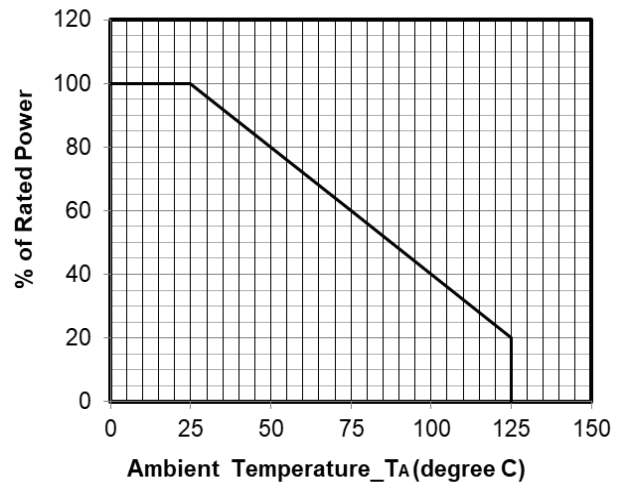

Power Derating Curve

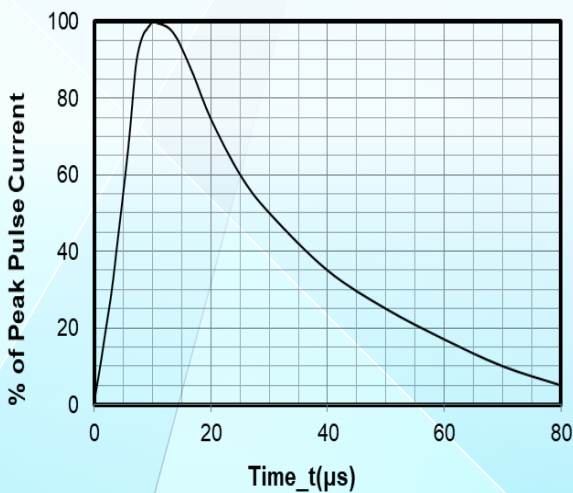

8 X 20 μs Pulse Waveform

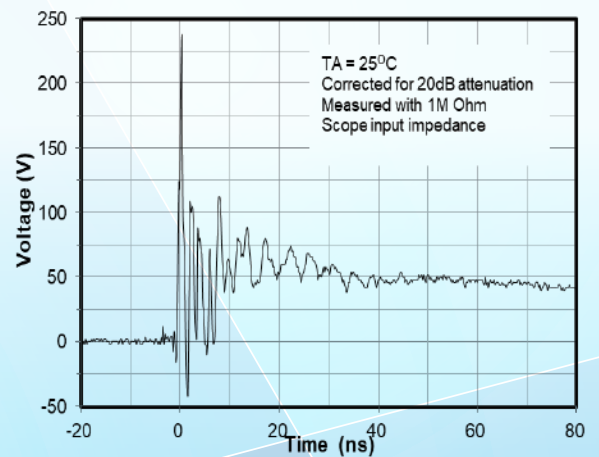

ESD Clamping Voltage
8 kV Contact per IEC61000-4-2

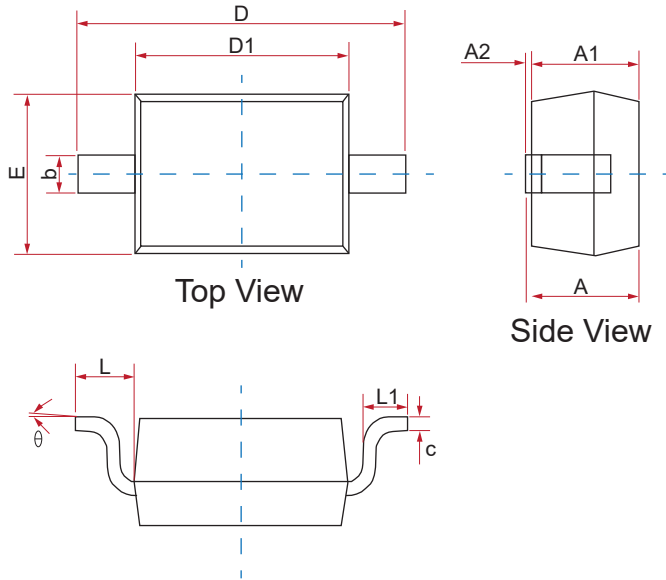
Physical Dimensions(mm.)

Symbol	Dimensions In Millimeters		
	Min	Nom	Max
A	0.800	--	1.100
A1	0.800	--	0.900
A2	0.000	--	0.100
b	0.250	--	0.400
c	0.080	--	0.177
D1	1.600	1.700	1.800
D	2.300	--	2.800
E	1.150	--	1.400
L	0.475REF		
L1	0.100	--	0.500
θ	0°	--	8°

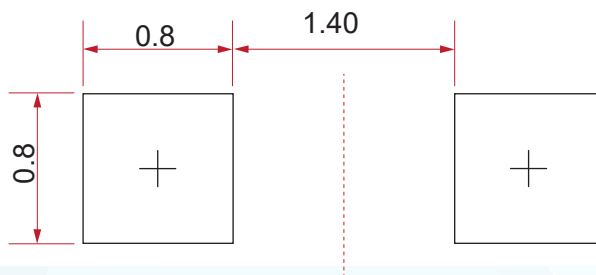
Suggested Land Pattern

Unit:mm

Packaging Quantity

Part Number	Delivery Form	Delivery Quantity
JED323-8V-LC	7"T&R	3,000

Soldering Parameters

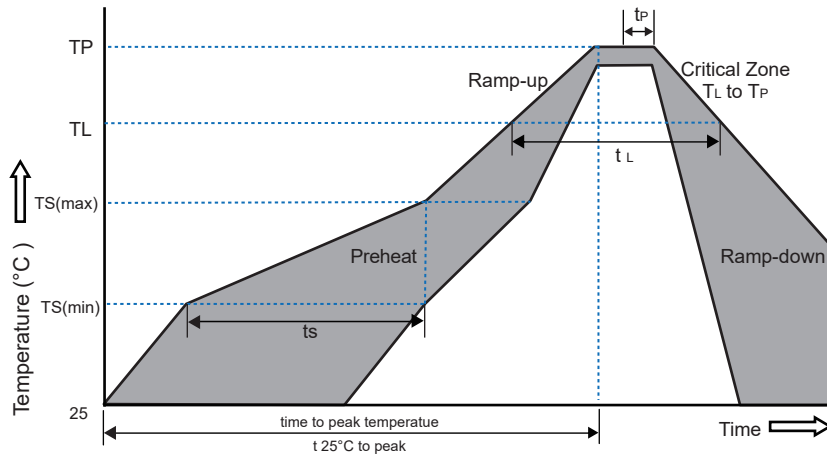

Reflow Condition		Pb-Free Assembly
Pre-heat	-Temperature Min($T_{s(min)}$)	+150°C
	-Temperature Max($T_{s(max)}$)	+200°C
	-Time(Min to Max)(t_s)	60~180 secs.
Average ramp up rate (Liquid us Temp(T_L) to peak)		3°C/sec. Max
Ts(max) to T_L - Ramp-up Rate		3°C/sec. Max
Reflow	-Temperature(T_L)(Liquid us)	+217°C
	-Temperature (t_L)	60~150 secs.
Peak Temp (T_p)		+260(+0/-5)°C
Time within 5°C of actual Peak Temp (t_p)		30 secs. Max
Ramp-down Rate		6°C/sec. Max
xTime 25°C to Peak Temp (TP)		8 min. Max
Do not exceed		+260°C

Part Number System

JE D323 - 8V - L C

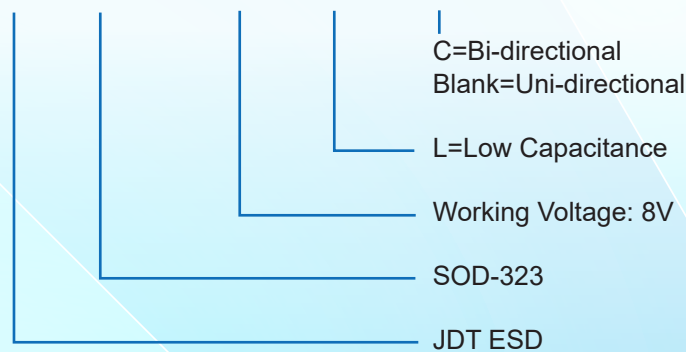

X-ON Electronics

Largest Supplier of Electrical and Electronic Components

Click to view similar products for [ESD Suppressors](#) / [TVS Diodes](#) category:

Click to view products by [JDT](#) manufacturer:

Other Similar products are found below :

[60KS200C](#) [D18V0L1B2LP-7B](#) [D5V0F4U5P5-7](#) [DESD5V0U1BB-7](#) [NTE4902](#) [P4KE27CA](#) [P6KE11CA](#) [P6KE39CA-TP](#) [P6KE8.2A](#)
[SA110CA](#) [SA60CA](#) [SA64CA](#) [SMBJ12CATR](#) [SMBJ33CATR](#) [SMBJ8.0A](#) [ESD101-B1-02ELS E6327](#) [ESD105-B1-02EL E6327](#) [ESD112-B1-02EL E6327](#) [ESD119B1W01005E6327XTSA1](#) [ESD5V0L1B02VH6327XTSA1](#) [ESD7451N2T5G](#) [19180-510](#) [CPDT-5V0USP-HF](#)
[3.0SMCJ33CA-F](#) [3.0SMCJ36A-F](#) [HSPC16701B02TP](#) [D3V3Q1B2DLP3-7](#) [D55V0M1B2WS-7](#) [DESD5V0U1BL-7B](#) [DRTR5V0U4SL-7](#)
[SCM1293A-04SO](#) [ESD200-B1-CSP0201 E6327](#) [SM12-7](#) [SMLJ45CA-TP](#) [CEN955 W/DATA](#) [82350120560](#) [VESD12A1A-HD1-GS08](#)
[CPDUR5V0R-HF](#) [CPDQC5V0U-HF](#) [CPDQC5V0USP-HF](#) [CPDQC5V0-HF](#) [D1213A-01LP4-7B](#) [D1213A-02WL-7](#) [MMAD1108/TR13](#)
[5KP100A](#) [5KP15A](#) [5KP18A](#) [5KP48A](#) [5KP90A](#) [5KP90CA](#)