

为您的产品保驾护航

PRODUCT DATASHEET

Electro-Static Discharge

JED523-5V-ULC ESD

Features

- Package: SOD-523
- Ultra low capacitance: 0.3pF typical
- Ultra low leakage: nA level
- Operating voltage: 5V
- Low clamping voltage
- Complies with following standards:
 - IEC 61000-4-2 (ESD) immunity test
 - Air discharge: $\pm 25\text{kV}$
 - Contact discharge: $\pm 22\text{kV}$
 - IEC61000-4-5 (Lightning) 4A (8/20 μs)
- RoHS compliant

Applications

- Cellular Handsets and Accessories
- Display Ports
- MDDI Ports
- USB Ports
- Digital Visual Interface (DVI)
- PCI Express and Serial SATA Ports

Schematic Diagram

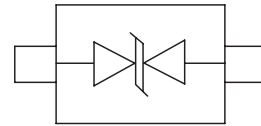

Pin Description



Limiting Values ($T_A = 25^\circ\text{C}$, unless otherwise specified)

Symbol	Parameter	Conditions	Value	Unit
V _{ESD}	Electrostatic Discharge Voltage	IEC 61000-4-2; Contact Discharge	± 22	kV
		IEC 61000-4-2; Air Discharge	± 25	kV
P _{Pk}	Peak Pulse Power	t _P =8/20 μs	100	W
I _{PP}	Peak Pulse Current	t _P =8/20 μs	4	A
T _J	Operating Temperature Range	-	-55 to +125	$^\circ\text{C}$
T _{stg}	Storage Temperature Range	-	-55 to +150	$^\circ\text{C}$

Electrical Characteristics ($T_A = 25^\circ\text{C}$, unless otherwise specified)

Symbol	Parameter	Conditions	Min	Typ.	Max	Unit
V _{RWM}	Reverse Working Voltage	T _A =25 $^\circ\text{C}$	-	-	5	V
V _{BR}	Breakdown Voltage	I _T =1mA	6.5	-	9.5	V
I _R	Reverse Leakage Current	V _{RWM} =5V; T _A =25 $^\circ\text{C}$	-	0.02	0.2	μA
V _C	Clamping Voltage	I _{PP} =1A(8x20 μs pulse)	-	-	12	V
V _C	Clamping Voltage	I _{PP} =4A(8x20 μs pulse)	-	-	25	V
C _J	Junction Capacitance	V _R =0V, f=1 MHz	-	0.3	0.5	pF

Typical Characteristics

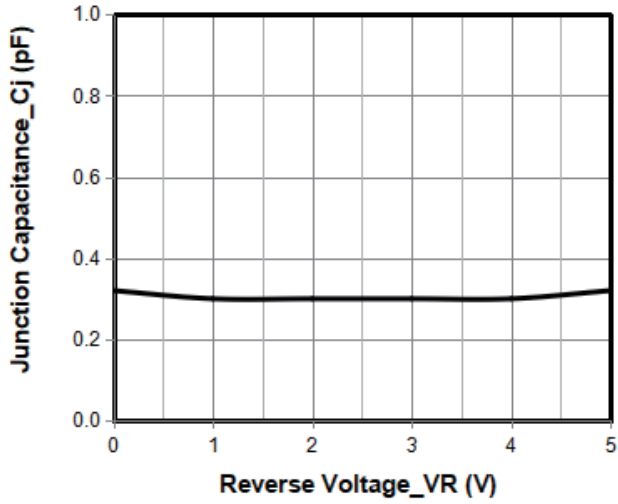

Junction Capacitance vs. Reverse Voltage

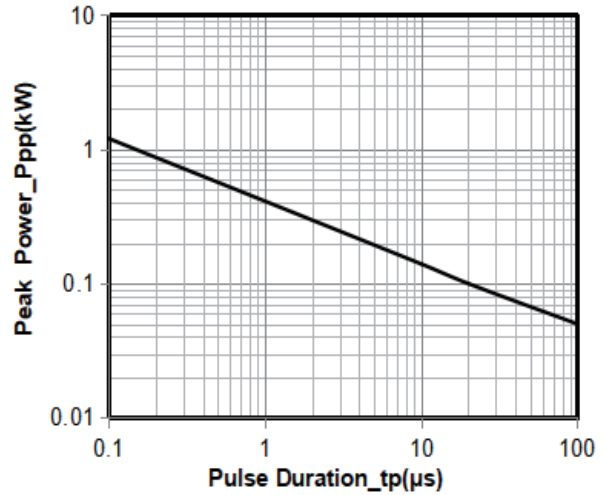

Peak Pulse Power vs. Pulse Time

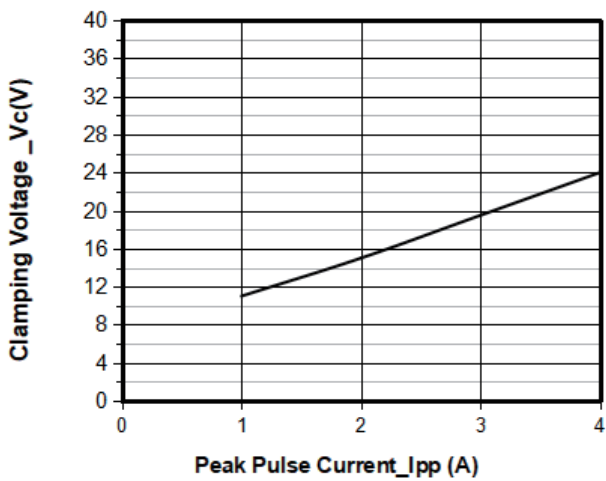

Clamping Voltage vs. Peak Pulse Current (tp = 8/20 μs)

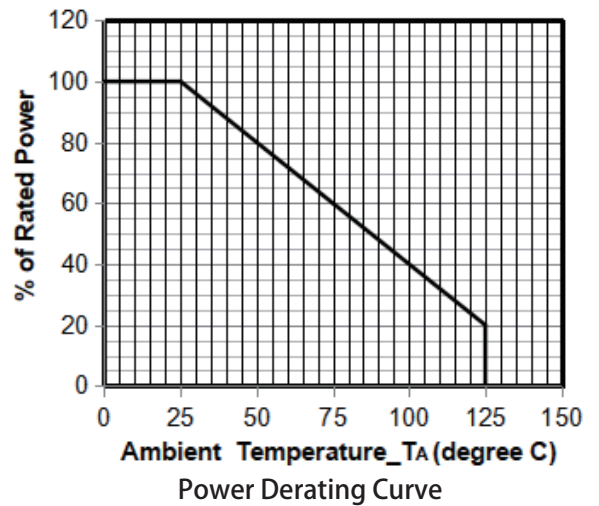

Power Derating Curve

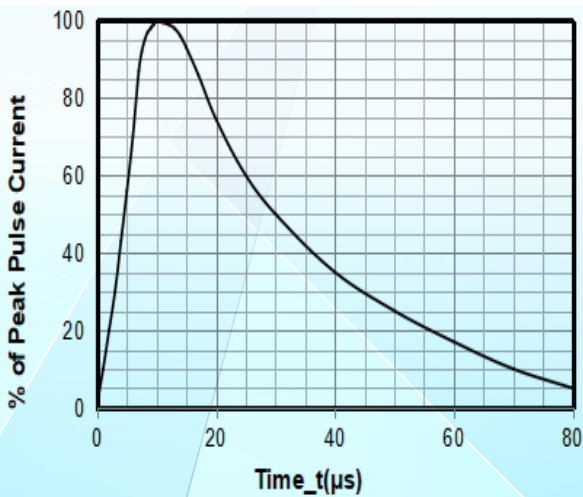

8x20 μs Pulse Waveform

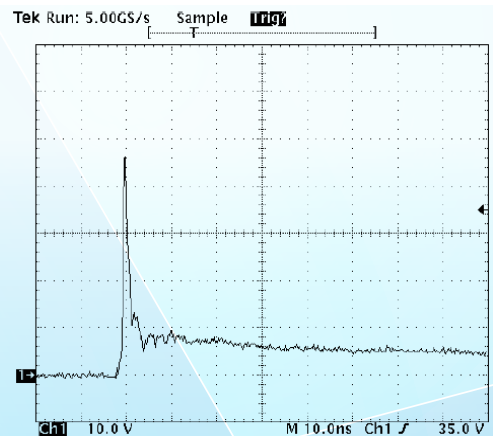

Note: Data is taken with a 10x attenuator
ESD Clamping Voltage
8 kV Contact per IEC61000-4-2

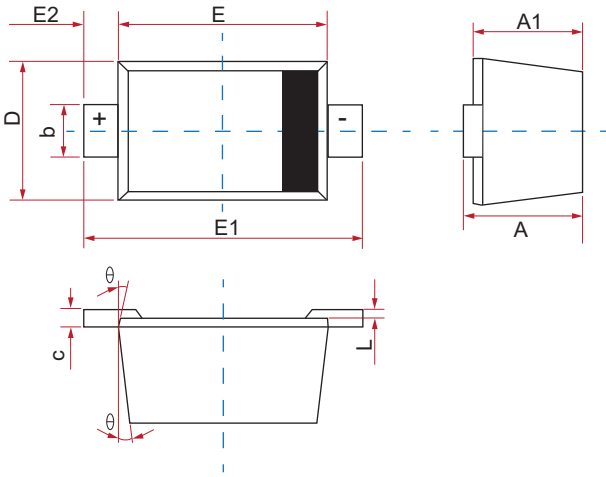
Physical Dimensions(mm.)

Symbol	Dimensions In Millimeters			Dimensions In Inches		
	Min	Nom	Max	Min	Nom	Max
A	0.51	--	0.77	0.020	--	0.031
A1	0.50	--	0.70	0.020	--	0.028
b	0.25	--	0.35	0.010	--	0.014
c	0.08	--	0.15	0.003	--	0.006
D	0.75	--	0.85	0.0030	--	0.033
E	1.10	--	1.30	0.043	--	0.051
E1	1.50	--	1.70	0.059	--	0.067
E2	0.20REF			0.008REF		
L	0.01	--	0.07	0.001	--	0.003
θ	7°REF			7°REF		

Suggested Land Pattern

Unit:mm

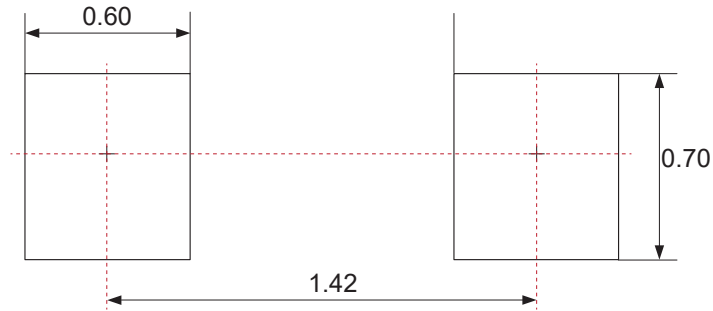
Packaging Quantity

Part Number	Delivery Form	Delivery Quantity
JED523-5V-ULC	7"T&R	3,000

Soldering Parameters

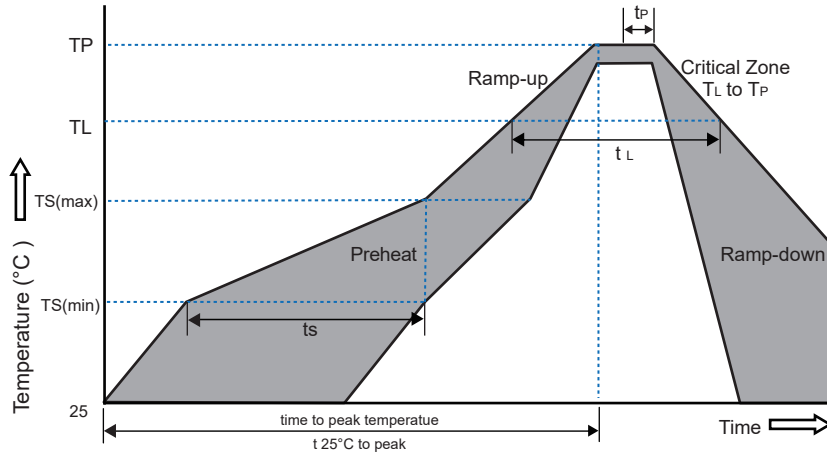

Reflow Condition		Pb-Free Assembly
Pre-heat	-Temperature Min($T_{s(min)}$)	+150°C
	-Temperature Max($T_{s(max)}$)	+200°C
	-Time(Min to Max)(t_s)	60~180 secs.
Average ramp up rate (Liquid us Temp(T_L) to peak)		3°C/sec. Max
Ts(max) to T_L - Ramp-up Rate		3°C/sec. Max
Reflow	-Temperature(T_L)(Liquid us)	+217°C
	-Temperature (t_L)	60~150 secs.
Peak Temp (T_P)		+260(+0/-5)°C
Time within 5°C of actual Peak Temp (t_p)		30 secs. Max
Ramp-down Rate		6°C/sec. Max
xTime 25°C to Peak Temp (TP)		8 min. Max
Do not exceed		+260°C

Part Number System

JE D523 - 5V - U L C

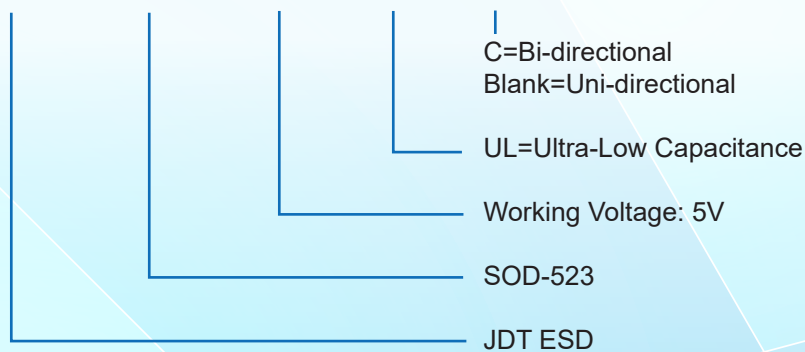

X-ON Electronics

Largest Supplier of Electrical and Electronic Components

Click to view similar products for [ESD Suppressors / TVS Diodes](#) category:

Click to view products by [JDT](#) manufacturer:

Other Similar products are found below :

[60KS200C](#) [D18V0L1B2LP-7B](#) [D5V0F4U5P5-7](#) [NTE4902](#) [P4KE27CA](#) [P6KE11CA](#) [P6KE8.2A](#) [SA60CA](#) [SA64CA](#) [SMBJ12CATR](#)
[SMBJ33CATR](#) [SMBJ6.5A](#) [SMBJ8.0A](#) [ESD101-B1-02ELS](#) [E6327](#) [ESD112-B1-02EL](#) [E6327](#) [ESD7451N2T5G](#) [19180-510](#) [CPDT-5V0USP-](#)
[HF](#) [3.0SMCJ33CA-F](#) [3.0SMCJ36A-F](#) [HSPC16701B02TP](#) [JANTX1N6126A](#) [D3V3Q1B2DLP3-7](#) [D55V0M1B2WS-7](#) [SCM1293A-04SO](#)
[ESD200-B1-CSP0201](#) [E6327](#) [SM12-7](#) [CEN955](#) [W/DATA](#) [VESD12A1A-HD1-GS08](#) [CPDQC5V0-HF](#) [D1213A-01LP4-7B](#) [ESD101-B1-02EL](#)
[E6327](#) [AOZ8808DI-03](#) [5KP15A](#) [5KP48A](#) [5KP90A](#) [ESD3V3D7-TP](#) [15KPA36A-LF](#) [P4KE56CA](#) [P4KE68A](#) [P4KE91CATR](#) [P6KE120A](#)
[P6KE13CA](#) [P6KE43CA](#) [P6KE6.8CA](#) [P6KE8.2](#) [P6SMBJ20CA](#) [JANTX1N6072A](#) [SR2835ESKG](#) [SA90CA](#)