

承 认 书

SPECIFICATION FOR APPROVAL

客户名称: Customer _____

货 名: Description HC-49SSMD 石英晶体谐振器

客户料号: Part No _____

物料编号: Code No 49SAT13560161050JY

频 率: Frequency 13.560MHz

日 期: Date 2020-06-09

备 注: RoHS compliance with Directive (EU) 2015/863

制作(Prepare by)	检查(Check by)	批准 (Approve by)
江丹娜	甘瑛	张刚

客户批准 Approve by customer	
批准日期 Approval date	

Add:广东省深圳市华发北路桑达工业区桑达雅苑 7P

7 P Sangda Yayuan Huafa North Road, Futian District, Shenzhen, Guangdong

Tel: 86-755-83048260

86-755-83048290

Fax: 86-755-83048280

1、 Specifications

1	规格型号 Holder Type	HC-49SSMD
2	标称频率 Nominal Frequency	13.560MHz
3	振动模式 Mode of Oscillation	基频
4	调整频差 Frequency Tolerance at 25°C	±10ppm
5	温度频差 Temperature Frequency Stability	±30ppm
6	工作温度 Operating Temperature Range	-40~85°C
7	贮存温度 Storage Temperature Range	-40~90°C
8	负载电容 Load Capacitance	16pF
9	静电容 Shunt capacitance	≤7 pF
10	等效电阻 Equivalent Series Resistance	50Ω Max
11	激励功率 Drive Level	10uW
12	绝缘阻抗 Insulation Resistance	500MΩ min./DC100V

2、 Frequency stability over temperature range (AT cut)

Temperature Range	Frequency Stability							
	±3PPM	±5PPM	±7.5PPM	±10PPM	±20PPM	±30PPM	±50PPM	±70PPM
0°C~+50°C	☆	☆	☆	☆	☆	☆	☆	☆
-10°C~+60°C			☆	☆	☆	☆	☆	☆
-20°C~+70°C				☆	☆	☆	☆	☆
-30°C~+70°C					☆	☆	☆	☆
-40°C~+85°C						☆	☆	☆
-40°C~+125°C						☆	☆	☆

3、Dimensions (unit:mm)

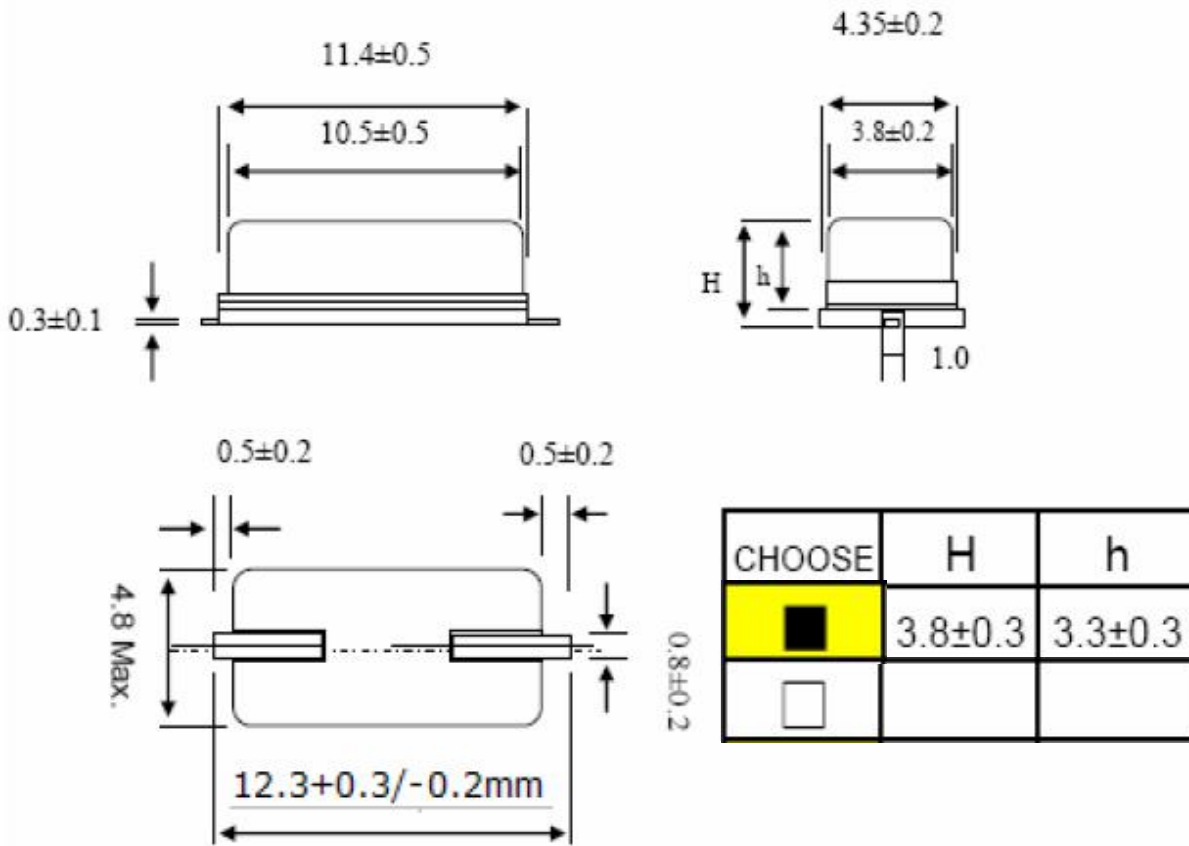

4、 Recommended Reflow profile

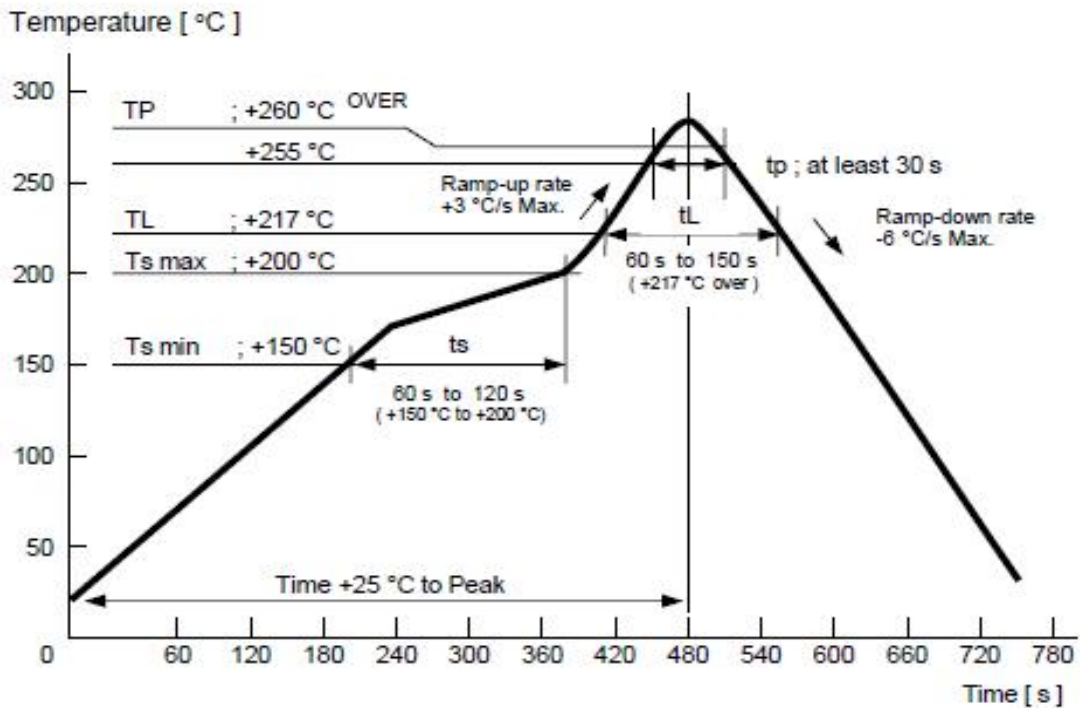

5、Reliability specifications

NO	Item	Condition	Standard
1.	Drop Test	Free drop from 50cm height on a hard wooden board for 3 times. (Board is thickness more than 30 mm.)	Frequency change: ≤5ppm Rr as specification
2.	Mechanical Shock	Half sine wave, 1000G, 0.5mS, three times for all 3 directions	Frequency change: ≤5ppm Rr as specification
3.	Vibration	Frequency range:10~55hz Amplitude:1.52mm Sweep time:1mintutes perpendicular axes each test time:2Hrs	Frequency change: ≤5ppm Rr as specification
4.	Solderability	Temperature:245℃±5℃ Immersing depth:0.5mm minimum Immersion time:5±1sec. Flux:Rosin resin methyl alcohol solvent(1:4)	90% exhibit tin ok
5.	Resistance to soldering heat	Test temperature:260℃±5℃ Test time :10±1sec.	Frequency change: ≤10ppm Rr as specification
6.	High Temp & Humidity	85±3℃ & RH85%, 500±12 hours	Frequency change: ≤10ppm Rr as specification
7.	Low temperature storage	-40±3℃, 500±12 hours	Frequency change: ≤10ppm Rr as specification
8.	High temperature storage	+85±3℃, 500±12 hours	Frequency change: ≤10ppm Rr as specification
9.	Temperature cycling	-40±3℃/10min~+85±3℃/10min, 100cycles	Frequency change: ≤10ppm Rr as specification

6、Tape & Reel (unit: mm)



A	B	C	D	E	F
1.55±0.1	4.0±0.1	12.0±0.1	11.5±0.1	24.0±0.3	3.5±0.2

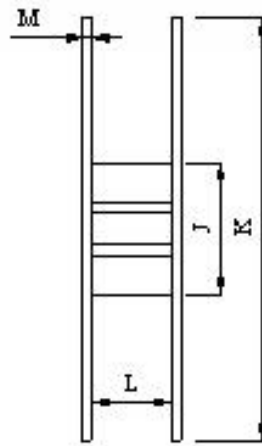
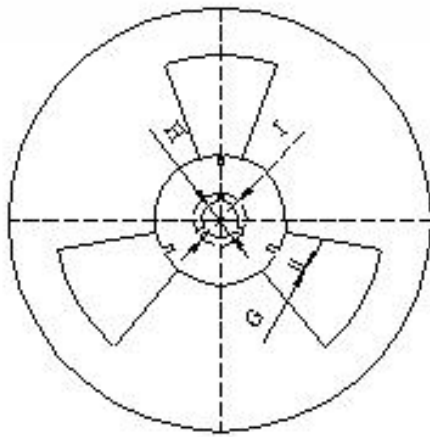

G	H	I	J	K	L	M
2.2±0.5	13.0±0.2	20.2±1.0	100.0±1.0	330±2.0	24.5±0.3	2.3±0.5

7、Packing

1. 每盘数量 Capacity of a plastic reel : 1000 PCS
2. 每内箱数量 Capacity per inner box : 1000 PCS (A reel inner)
3. 每大箱数量 Capacity per outer carton : 10000 PCS (10× inner box) .

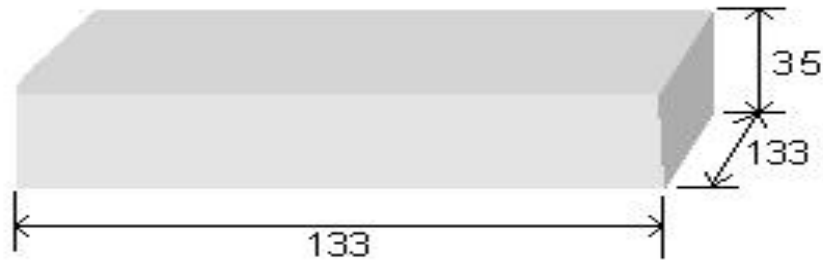

X-ON Electronics

Largest Supplier of Electrical and Electronic Components

Click to view similar products for [Resonators](#) category:

Click to view products by [JGHC](#) manufacturer:

Other Similar products are found below :

[B39431R820H210](#) [CSAC2.00MGCM-TC](#) [ECS-HFR-40.00-B-TR](#) [CSTLS4M00G53Z-A0](#) [ZTB455E](#) [ECS-CR2-16.00-A-TR](#) [ECS-HFR-20.00-B-TR](#) [ECS-CR2-20.00-A-TR](#) [RO3164E-3](#) [ASR418S2-T](#) [CSTNE10M0G520000R0](#) [CSTLS8M00G53093-A0](#) [CSTNE12M0G52A000R0](#) [CSTLS18M4X54-A0](#) [CSTLS16M9X53Z-B0](#) [CSTLS24M0X51-A0](#) [CSTLS25M0X51-B0](#) [CSTLS18M0X51-B0](#) [CSTLS4M00G53093-A0](#) [CSTLS18M4X53-A0](#) [CSTNE16M0V510000R0](#) [CSTLS30M0X53-B0](#) [CSTLS33M8X53-B0](#) [CSTLS16M9X53-A0](#) [CSTLS6M40G56-B0](#) [CSTLS6M25G56-A0](#) [CSTNE14M7V510000R0](#) [CSTLS18M4X53-B0](#) [CSTLS33M0X51-B0](#) [CSTLS5M50G56-B0](#) [7B008000I01](#) [7D038400I01](#) [TAXM24M2ILDBET2T](#) [TAXM26M2IHDBET2T](#) [146-32.768-12.5-20-20/A](#) [3225-24.00-12-10-10/A](#) [7B009843M01](#) [CF4016M00009T8188042](#) [S32400001B0730D1JB](#) [X252016MLB4SI](#) [Q24FA20H00389](#) [CSTLS16M0X54-B0](#) [CSTLS4M19G56-B0](#) [9AC04194152080D2JB](#) [CST3.58MGW](#) [CSTCR4M91G55B-R0](#) [CSTLS3M68G56-B0](#) [S2100327072090](#) [FC-12M32.768KHZ9PF20PPM](#) [7Y032768NW2](#)