

1、 Specifications

1	规格型号 Holder Type	HC-49S
2	标称频率 Nominal Frequency	25.000MHZ
3	振动模式 Mode of Oscillation	基频
4	调整频差 Frequency Tolerance at 25°C	±20ppm
5	温度频差 Temperature Frequency Stability	±30ppm
6	工作温度 Operating Temperature Range	-40~85°C
7	贮存温度 Storage Temperature Range	-40~90°C
8	负载电容 Load Capacitance	16 pF
9	静电容 Shunt capacitance	≤7 pF
10	等效电阻 Equivalent Series Resistance	40 Ω Max
11	激励功率 Drive Level	50uW
12	绝缘阻抗 Insulation Resistance	500MΩ min./DC100V

2、 Frequency stability over temperature range (AT cut)

Temperature Range	Frequency Stability							
	±3PPM	±5PPM	±7.5PPM	±10PPM	±20PPM	±30PPM	±50PPM	±70PPM
0°C~+50°C	☆	☆	☆	☆	☆	☆	☆	☆
-10°C~+60°C			☆	☆	☆	☆	☆	☆
-20°C~+70°C				☆	☆	☆	☆	☆
-30°C~+70°C					☆	☆	☆	☆
-40°C~+85°C						☆	☆	☆
-40°C~+125°C						☆	☆	☆

3、Dimensions (unit:mm)



4、Recommended Reflow profile

Condition:



5、Reliability specifications

NO	Item	Condition	Standard
1.	Drop Test	Free drop from 50cm height on a hard wooden board for 3 times. (Board is thickness more than 30 mm.)	Frequency change: ≤5ppm Rr as specification
2.	Mechanical Shock	Half sine wave, 1000G, 0.5mS, three times for all 3 directions	Frequency change: ≤5ppm Rr as specification
3.	Vibration	Frequency range:10~55hz Amplitude:1.52mm Sweep time:1mintutes perpendicular axes each test time:2Hrs	Frequency change: ≤5ppm Rr as specification
4.	Solderability	Temperature:245℃±5℃ Immersing depth:0.5mm minimum Immersion time:5±1sec. Flux:Rosin resin methyl alcohol solvent(1:4)	90% exhibit tin ok
5.	Resistance to soldering heat	Test temperature:260℃±5℃ Test time :10±1sec.	Frequency change: ≤10ppm Rr as specification
6.	High Temp & Humidity	85±3℃ & RH85%, 500±12 hours	Frequency change: ≤10ppm Rr as specification
7.	Low temperature storage	-40±3℃, 500±12 hours	Frequency change: ≤10ppm Rr as specification
8.	High temperature storage	+85±3℃, 500±12 hours	Frequency change: ≤10ppm Rr as specification
9.	Temperature cycling	-40±3℃/10min~+85±3℃/10min, 100cycles	Frequency change: ≤10ppm Rr as specification

6、Packaging standard

Dimension of Inside Package

内包装尺寸图

Dimensions of outside Package

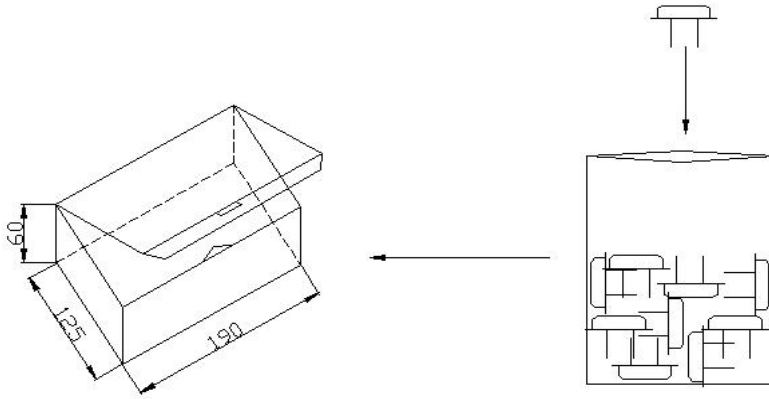

外包装尺寸图



7-1. MARKING

- (1) Marking Labels are affixed to reel, inner carton and outer carton.
- (2) Each label contains the following information.
 - (a) Manufacture's name or symbol
 - (b) Parts name or type
 - (c) Frequency
 - (d) Quantity
 - (e) Reel number
 - (f) Manufacturer's code (EIAJ code)

7-2. QUANTITY

200pcs/bag

7-3. STORAGE ENVIRONMENT

- ✧ Storage the reel at normal temperature and humidity
- ✧ Open the packing just before using
- ✧ Do not expose the sun
- ✧ Do not storage with some erosive chemicals
- ✧ Nothing is allowed to put on the reel or carton to prevent mechanical damage

7-4. HANDLING

- ✧ Handle with care to prevent the damage of tape, reel and products.

X-ON Electronics

Largest Supplier of Electrical and Electronic Components

Click to view similar products for [Crystals](#) category:

Click to view products by [JGHC](#) manufacturer:

Other Similar products are found below :

[CX3225GB25000M0PPSZ1](#) [718-13.2-1](#) [MC405 32.0000K-R3:PURE SN](#) [7A-40.000MAAE-T](#) [FL2000085](#) [99-BU](#) [9B-15.360MBBK-B](#) [9C-7.680MBBK-T](#) [H10S-12.000-18-EXT-TR](#) [ABC2-6.000MHZ-D4Z-T](#) [ABLS-20.000MHZ-D2-T](#) [ABS071-32.768KHZ-6-T](#) [R38-32.768-12.5-5PPM-NPB](#) [BTD1062E05A-513](#) [21U15A-21.4MHZ](#) [RTX-781DF1-S-20.950](#) [LFXTAL066198Cutt](#) [9C-14.31818MBBK-T](#) [A-11.000MHZ-27](#) [ABL-27.000MHZ-B4Y-T](#) [ABM11-132-24.000MHZ-T3](#) [ABM3B1-25.000MHZ-D2Y-T](#) [SPT2A-.032768B](#) [SPT2A.032768G](#) [SSPT7F-9PF20-R](#) [FX325BS-38.88EEM1201](#) [LFXTAL065253Cutt](#) [LFXTAL066431Cutt](#) [XT9S20ANA14M7456](#) [XT9SNLANA16M](#) [646G-24-2](#) [7A-24.576MBBK-T](#) [7B-30.000MBBK-T](#) [7A-14.31818MBBK-T](#) [6504-202-1501](#) [6526-202-1501](#) [ABLS-12.000MHZ-B2Y-T](#) [7A-10.000MBBK-T](#) [SG636PCE-20.000MC](#) [3404](#) [E1SAA18-25.000M TR](#) [CM315D32768EZFT](#) [C1E-24.000-7-2020-R](#) [C1E-19.200-12-1530-X-R](#) [C1E-16.000-12-1530-X-R](#) [ABM11-16.000MHZ-9-B1U-T](#) [FL5000014](#) [EUCA18-3.1872M](#) [FX0800015](#) [425F35E027M0000](#)