

承 认 书

SPECIFICATION FOR APPROVAL

客户名称: Customer _____

货 名: Description SMD 7040 石英晶体谐振器

客户料号: Part No _____

物料编号: Code No P7426000091040

频 率: Frequency 26.000MHz

日 期: Date 2020-05-21

备 注: RoHS compliance with Directive (EU) 2015/863

制作(Prepare by)	检查(Check by)	批准 (Approve by)
江丹娜	甘瑛	张刚

客户批准 Approve by customer	
批准日期 Approval date	

Add: 广东省深圳市华发北路桑达工业区桑达雅苑 7P

7 P Sangda Yayuan Huafa North Road, Futian District, Shenzhen, Guangdong

Tel: 86-755-83048260

86-755-83048290

Fax: 86-755-83048280

1、 Specifications

1	规格型号 Holder Type	SMD7040
2	标称频率 Nominal Frequency	26.000MHz
3	振荡模式 Mode of Oscillation	Fundamental
4	调整频差 Frequency Tolerance at 25°C	±10ppm
5	温度频差 Temperature Frequency Stability	±20ppm
6	工作温度 Operating Temperature Range	-20~70°C
7	贮存温度 Storage Temperature Range	-40~85°C
8	负载电容 Load Capacitance	9pf
9	静态电容 Shunt capacitance	≤7 pf
10	动态电容 Dynamic capacitance	15fF ±10%
11	等效电阻 Equivalent Series Resistance	40 Ω Max
12	激励功率 Drive Level	100uW
13	绝缘阻抗 Insulation Resistance	500MΩ/100V±15V _{DC}
14	年老化率 Aging	±5ppm/First year
15	测试仪器 Test machine	250B

2. Frequency stability over temperature range (AT cut)

Temperature Range	Frequency Stability							
	±3PPM	±5PPM	±7.5PPM	±10PPM	±20PPM	±30PPM	±50PPM	±70PPM
0°C~+50°C	☆	☆	☆	☆	☆	☆	☆	☆
-10°C~+60°C			☆	☆	☆	☆	☆	☆
-20°C~+70°C				☆	★	☆	☆	☆
-30°C~+70°C					☆	☆	☆	☆
-40°C~+85°C						☆	☆	☆
-40°C~+125°C						☆	☆	☆

3. Dimensions (unit:mm)

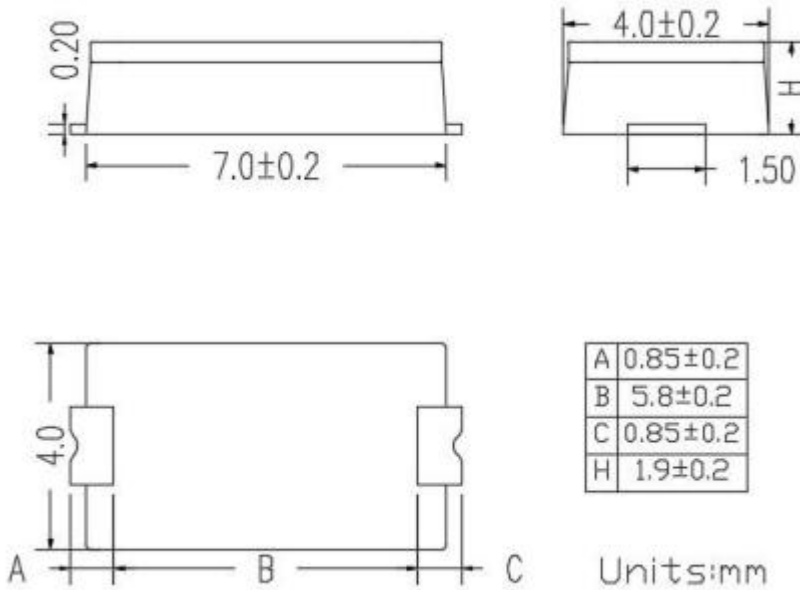

4.Recommended Reflow profile

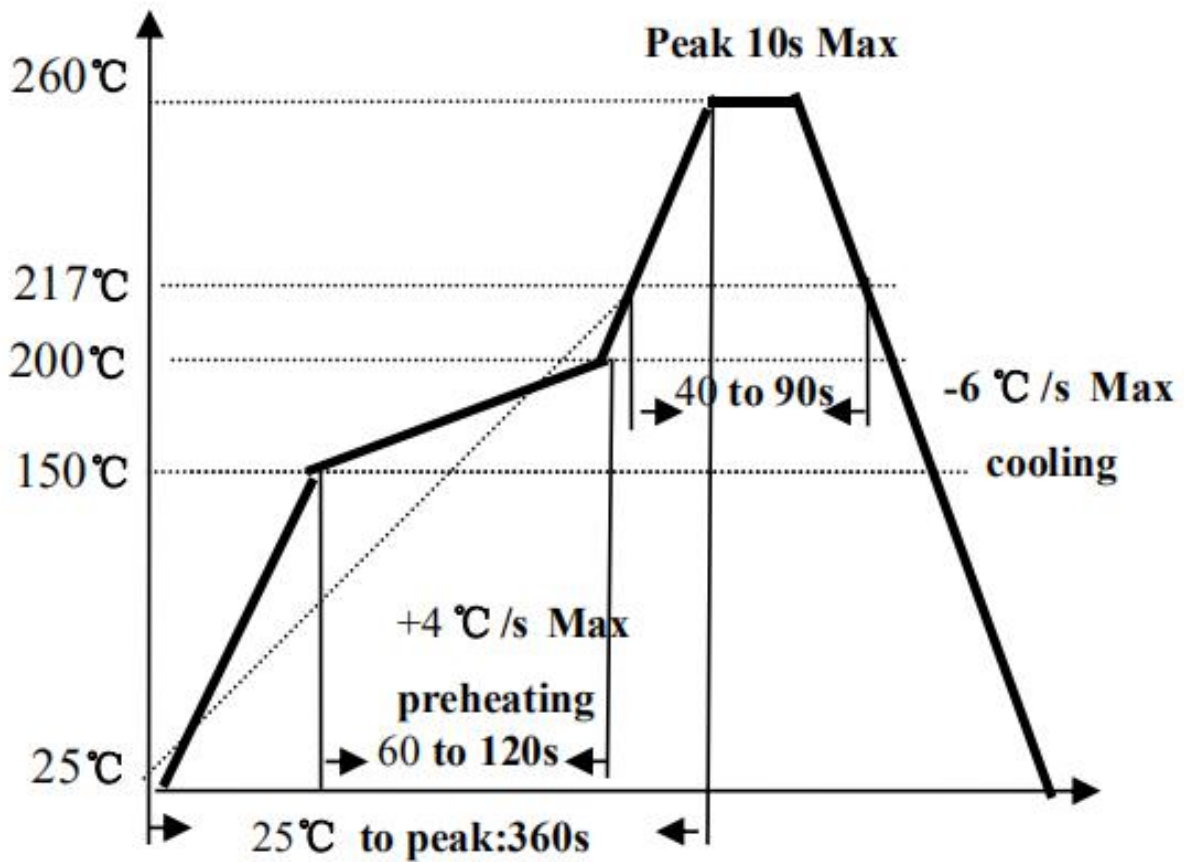

5. Reliability specifications

Test Item 项目	Condition of test 实验条件及要求	Performance Requirements 性能要求
End Strength of Electrode 端强度	Applying 1000g force in the direction of extreme perpendicularity of the electric current for 10 +2s 在电极端垂直的方向施加 1000g 力, 时间为 10±2s	There should be no abnormalities detected on the unit 产品外观无异常
Vibration 振动	Endurance condition by a frequency sweep shall be made. The entire frequency range from 10HZ to 50HZ and return to 10HZ, shall be transverse in 1min. Amplitude(total excursion):1.5mm this motion shall be applied for a period of 2h each of 3 mutually perpendicular axes(a total of 6h) 振动频率: 从 10HZ 到 55HZ,再回到 10HZ 1 倍频程/min 幅度为 1.5mm 3 个相互垂直的方向各 2 小时	(1). Frequency Change: +/-5ppm (2). Resistance: +/-15 %
Drop 跌落	Form 70cm height 3 times on 3cm hard wooden floor 从 70cm 高处跌落到 3cm 厚的硬质木板上, 重复 3 次	
Shock 冲击	Peak acceleration:981m/s ² duration of the pulse :6ms three successive shocks shall be applied in both direction of 3 mutually perpendicular axes(a total of 18 shocks) 加速度: 981m/s ² 时间: 6ms 作用在 3 个相互垂直的方向	
Damp heat, constant 恒定湿热	The unit shall be stored at a temperature of 40°C±2°C with relative humidity of 90%to95% for 48h, then it shall be subjected to standard atmospheric conditions for 1~2h after which measurement shall be made. 在温度: 40°C±2°C、湿度: 90%to95%条件下存放 48 小时, 然后在标准大气压下放置 1~2 小时后测试	
Cold 低温存储	The unit shall be stored at a temperature of -40°C±5°C for 48h, then it shall be subjected to standard atmospheric conditions for 1~2h after which measurement shall be made. 在-40°C±5°C下存放 48 小时, 然后在标准大气压下放置 1~2 小时后测试	
Dry heat 高温存储	The unit shall be stored at a temperature of 100°C±5°C for 24h, then it shall be subjected to standard atmospheric conditions for 1~2h after which measurement shall be made. 100°C±5°C下存放 24 小时, 然后在标准大气压下放置 1~2 小时后测试	
Aging 老化	The unit shall be stored at a temperature of 85°C±5°C for 7d then it shall be subjected to standard atmospheric conditions for 1~2h after which measurement shall be made. 85°C±5°C下放置 7 天, 然后在标准大气压下放置 1~2 小时后测试	

Environmental 可靠性试验

Test Item 项目	Condition of test 实验条件及要求	Performance Requirements 性能要求															
Temperature cycling 温度循环	<p>The unit shall be subjected to 5 successive change of temperature cycles, each as show in table below, then it shall be subjected to standard atmospheric conditions for 1~2h after which measurement shall be made</p> <p>在下表给定温度和时间参数的条件下循环 5 次, 标准大气压下放置 1~2 小时后测试</p>	<p>(1).Frequency Change: +/-5ppm (2). Resistance:+/-15%</p>															
	<table border="1"> <thead> <tr> <th data-bbox="384 651 608 734">序号 The serial number</th> <th data-bbox="608 651 906 734">Temperature 温度</th> <th data-bbox="906 651 1123 734">Duration 放置时间</th> </tr> </thead> <tbody> <tr> <td data-bbox="384 734 608 786">1</td> <td data-bbox="608 734 906 786">-40℃±3℃</td> <td data-bbox="906 734 1123 786">30min (30 分钟)</td> </tr> <tr> <td data-bbox="384 786 608 913">2</td> <td data-bbox="608 786 906 913">Standard atmospheric conditions 标准大气压</td> <td data-bbox="906 786 1123 913">Within 30s 30 秒内</td> </tr> <tr> <td data-bbox="384 913 608 958">3</td> <td data-bbox="608 913 906 958">100℃±3℃</td> <td data-bbox="906 913 1123 958">30min (30 分钟)</td> </tr> <tr> <td data-bbox="384 958 608 1081">4</td> <td data-bbox="608 958 906 1081">Standard atmospheric conditions 标准大气压</td> <td data-bbox="906 958 1123 1081">Within 30s 30 秒内</td> </tr> </tbody> </table>		序号 The serial number	Temperature 温度	Duration 放置时间	1	-40℃±3℃	30min (30 分钟)	2	Standard atmospheric conditions 标准大气压	Within 30s 30 秒内	3	100℃±3℃	30min (30 分钟)	4	Standard atmospheric conditions 标准大气压	Within 30s 30 秒内
	序号 The serial number		Temperature 温度	Duration 放置时间													
	1		-40℃±3℃	30min (30 分钟)													
	2		Standard atmospheric conditions 标准大气压	Within 30s 30 秒内													
3	100℃±3℃	30min (30 分钟)															
4	Standard atmospheric conditions 标准大气压	Within 30s 30 秒内															

6、上板焊接使用要求

1. 使用贴片机自动上板贴片。
2. 手动焊接时不能使用风枪直对准上盖通过整个产品导热进行焊接, 可设置温度 240 度以下通过 45 度倾斜对准产品电极进行融锡焊接。

7. Type & Reel 编带类型及卷盘

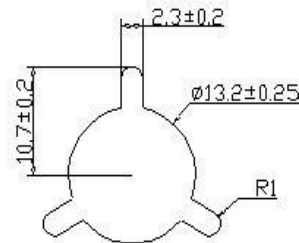
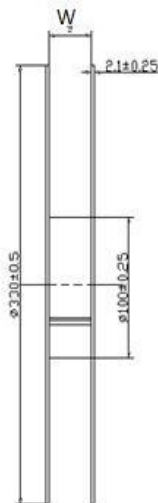
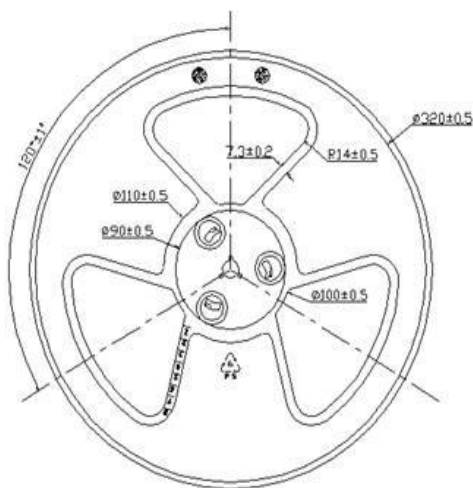
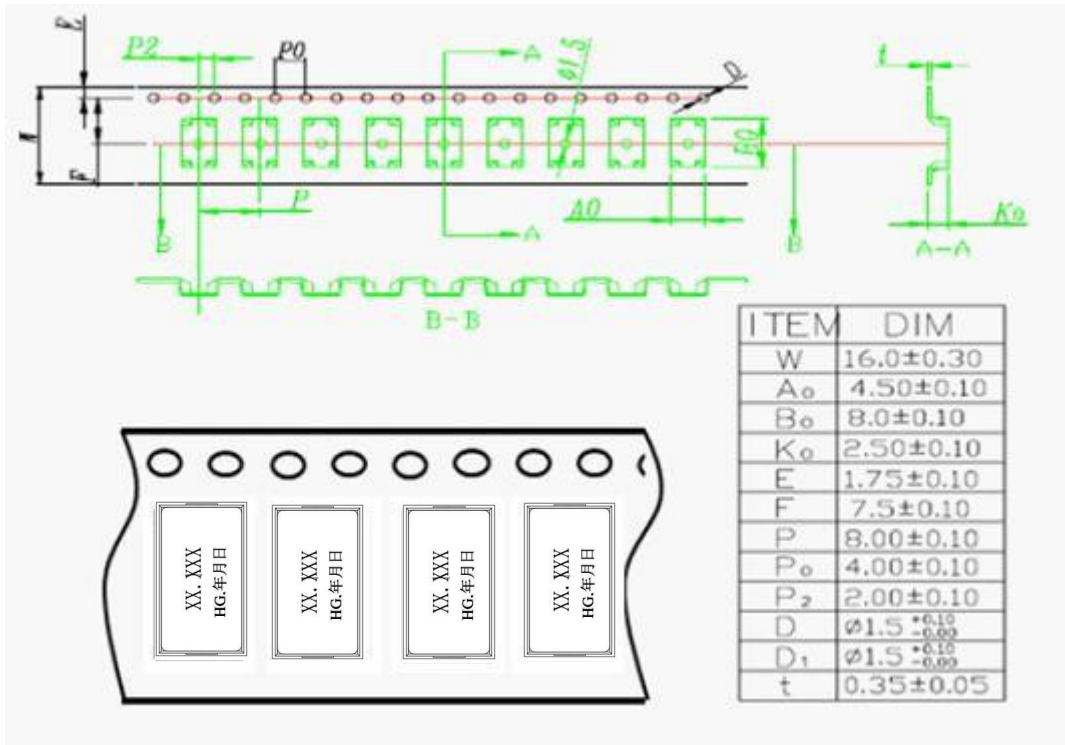

Available Reel Size (mm) \varnothing	
Tape width \varnothing	$W \pm 0.3$ mm \varnothing
24 mm \varnothing	24.4 \varnothing

8. Packing Specification 包装说明

1. 每小盒数量: 3000PCS
2. 每大箱数量: 30000PCS (10×inner box)

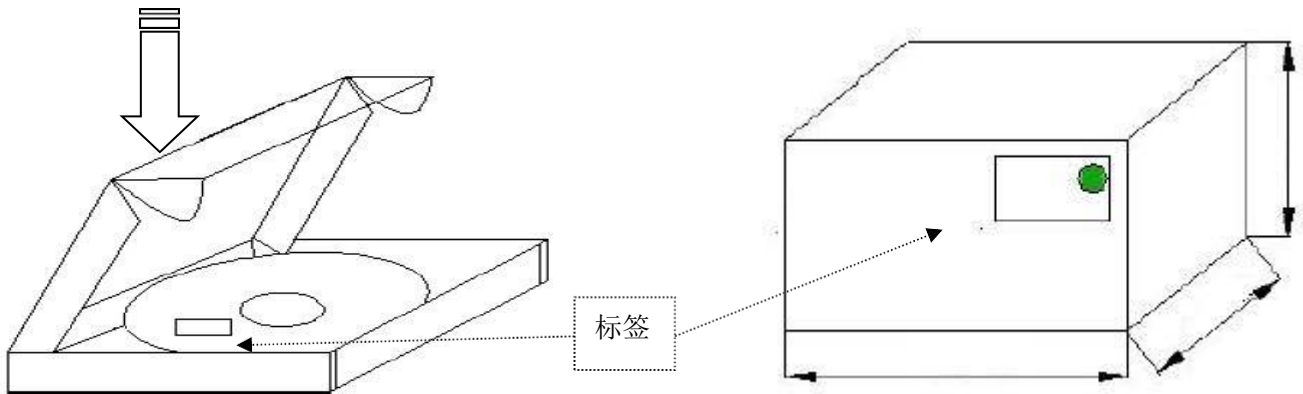

1 盒放 1 盘 (3000PCS)

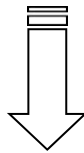

外箱放 10 盒 (30000PCS)

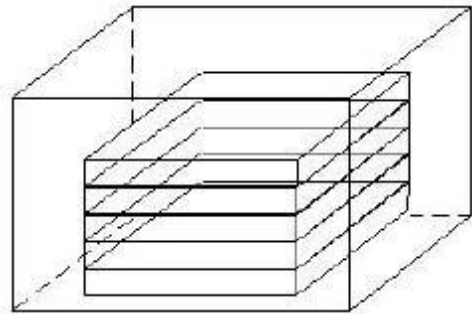

9. MARKING



年份	2019	2020	2021	2022	2023	2024	2025	2026	2027	2028	2029	2030
代码	9	0	1	2	3	4	5	6	7	8	9	0
月份	1月	2月	3月	4月	5月	6月	7月	8月	9月	10月	11月	12月
代码	1	2	3	4	5	6	7	8	9	O	N	D
日期	1	2	3	4	5	6	7	8	9	10	11	12
代码	A	B	C	D	E	F	G	H	I	J	K	L
日期	13	14	15	16	17	18	19	20	21	22	23	24
代码	M	N	O	P	Q	R	S	T	U	V	W	X
日期	25	26	27	28	29	30	31					
代码	Y	Z	1	2	3	4	5					

如2019年11月12日生产40M产品，则打标为：

**40.000
HG.9NL**

X-ON Electronics

Largest Supplier of Electrical and Electronic Components

Click to view similar products for [Crystals](#) category:

Click to view products by [JGHC](#) manufacturer:

Other Similar products are found below :

[CS325S24000000ABJT](#) [718-13.2-1](#) [MC405 32.0000K-R3:PURE SN](#) [FC-135R 32.7680KF-A3](#) [7A-40.000MAAE-T](#) [7B-27.000MBBK-T](#)
[FL2000085](#) [9B-15.360MBBK-B](#) [9C-7.680MBBK-T](#) [ASH7K-32.768KHZ](#) [AT-41.600MAGQ-T](#) [BTD1062E05A-513](#) [LFX TAL066198Cutt](#)
[9C-14.31818MBBK-T](#) [FA-238 50.0000MB30X-K3](#) [FC-12M 32.7680KA-AC3](#) [SSPT7F-9PF20-R](#) [FX325BS-38.88EEM1201](#)
[LFX TAL065253Cutt](#) [LFX TAL066431Cutt](#) [XT9S20ANA14M7456](#) [XT9SNLANA16M](#) [646G-24-2](#) [7A-24.576MBBK-T](#) [7B-30.000MBBK-T](#)
[WX26-32.768K-6PF](#) [9B-14.31818MBBK-B](#) [CD1AM](#) [7B-25.000MAAE-T](#) [7A-14.31818MBBK-T](#) [6504-202-1501](#) [6526-202-1501](#) [FA-118T](#)
[27.1200MB50P-K0](#) [FC-135R 32.7680KA-A3](#) [ABM12-104-37.400MHZT](#) [ABLS-10.000MHZ-D3W-T](#) [BTJ112E01E-513](#) [BTJ722K01C-7067](#)
[BTL-20-513](#) [TSX-3225 24.0000MF15X-AC](#) [TSX-3225 16.0000MF18X-AC](#) [BTJ120E02C](#) [BTL-12-513](#) [7A-10.000MBBK-T](#) [7A-](#)
[11.0592MBBK-T](#) [ABM12-103-24.000MHZT](#) [CS325S25000000ABJT](#) [ABM3B-25.000MHZ-B2-X-T](#) [FC-135 32.7680KA-A5](#) [FX0800015](#)