

SRF2020CT THRU SRF20200CT



SCHOTTKY BARRIER RECTIFIER
Reverse Voltage - 20 to 200 Volts
Forward Current - 20Amperes

FEATURES

- Plastic package has Underwriters Laboratory Flammability Classification 94V-0
- Metal silicon junction ,majority carrier conduction
- Guard ring for overvoltage protection
- Low power loss ,high efficiency
- High current capability ,Low forward voltage drop
- High surge capability
- For use in low voltage ,high frequency inverters, free wheeling ,and polarity protection applications
- Dual rectifier construction
- High temperature soldering guaranteed:260° C/10 seconds., 0.25"(6.35mm)from case
- Component in accordance to RoHS 2002/95/EC and WEEE 2002/96/EC



ITO-220AB

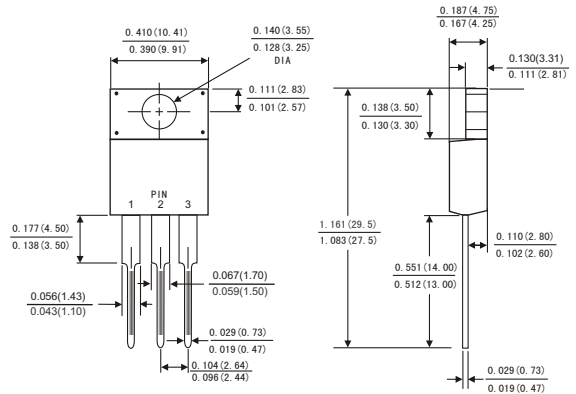

Dimensions in inches and (millimeters)

MECHANICAL DATA

- Case: JEDEC ITO-220AB molded plastic body
- Terminals: Lead solderable per MIL-STD-750,method 2026
- Polarity: As marked
- Mounting Position: Any
- Weight: 0.08ounce, 2.24 gram

MAXIMUM RATINGS AND ELECTRICAL CHARACTERISTICS

(Ratings at 25°C ambient temperature unless otherwise specified ,Single phase ,half wave ,resistive or inductive load. For capacitive load, derate by 20%.)

	Symbols	SRF 2020CT	SRF 2030CT	SRF 2040CT	SRF 2050CT	SRF 2060CT	SRF 2080CT	SRF 20100CT	SRF 20150CT	SRF 20200CT	Units
Maximum repetitive peak reverse voltage	V _{RRM}	20	30	40	50	60	80	100	150	200	Volts
Maximum RMS voltage	V _{RMS}	14	21	28	35	42	56	70	105	140	Volts
Maximum DC blocking voltage	V _{DC}	20	30	40	50	60	80	100	150	200	Volts
Maximum average forward rectified current(see Fig.1)	Per leg	10.0									Amps
	Total device	20.0									
Peak forward surge current 8.3ms single half sine-wave superimposed on rated load (JEDEC method)	I _{FSM}	200.0									Amps
Maximum instantaneous forward voltage at 20.0 A	V _F	0.60			0.75		0.85		0.90	0.95	Volts
Maximum instantaneous reverse current at rated DC blocking voltage(Note 1)	T _c = 25°C	0.2									mA
	T _c = 125°C	30			50						
Typical thermal resistance (Note 2)	R _{θJC}	3.0									°C/W
Operating junction temperature range	T _J	-65 to +150									°C
Storage temperature range	T _{STG}	-65 to +150									°C

- Notes: 1.Pulse test: 300 μs pulse width,1% duty cycle
2.Thermal resistance from junction to case

RATINGS AND CHARACTERISTIC CURVES SRF2020CT THRU SRF20200CT

FIG.1-FORWARD CURRENT DERATING CURVE

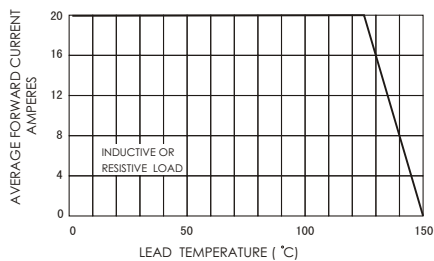

FIG.2-MAXIMUM NON-REPETITIVE PEAK FORWARD SURGE CURRENT

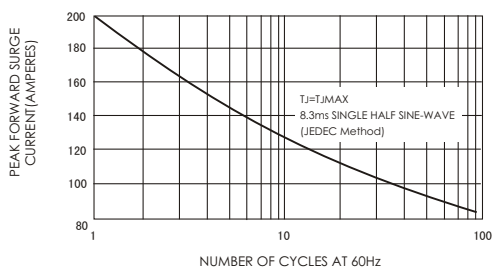

FIG.3-TYPICAL INSTANTANEOUS FORWARD CHARACTERISTICS

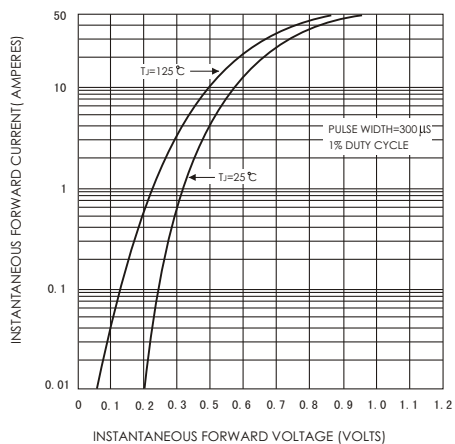

FIG.4-TYPICAL REVERSE CHARACTERISTICS

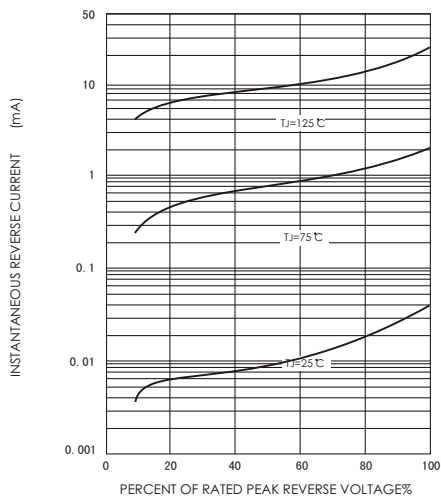

FIG.5-TYPICAL JUNCTION CAPACITANCE

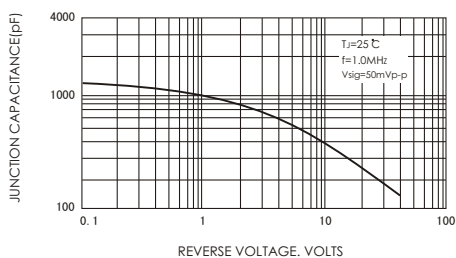
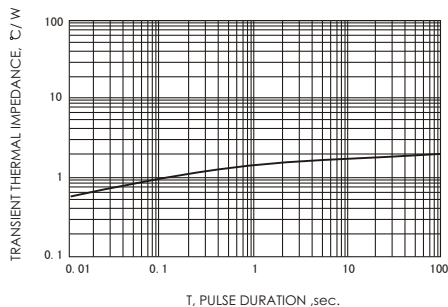

FIG.6-TYPICAL TRANSIENT THERMAL IMPEDANCE



X-ON Electronics

Largest Supplier of Electrical and Electronic Components

Click to view similar products for [Schottky Diodes & Rectifiers](#) category:

Click to view products by [JH](#) manufacturer:

Other Similar products are found below :

[CUS06\(Te85L,Q,M\)](#) [MA4E2039](#) [D1FH3-5063](#) [MBR0530L-TP](#) [MBR10100CT-BP](#) [MBR30H100MFST1G](#) [MMBD301M3T5G](#) [PMAD1103-LF](#) [PMAD1108-LF](#) [RB160M-50TR](#) [RB520S-30](#) [RB551V-30](#) [DD350N18K](#) [DZ435N40K](#) [DZ600N16K](#) [BAS16E6433HTMA1](#) [BAS 3010S-02LRH E6327](#) [BAT 54-02LRH E6327](#) [IDL02G65C5XUMA1](#) [NSR05F40QNXT5G](#) [NSVR05F40NXT5G](#) [JANS1N6640](#) [SB07-03C-TB-H](#) [SB1003M3-TL-W](#) [SBAT54CWT1G](#) [SBM30-03-TR-E](#) [SBS818-TL-E](#) [SK32A-LTP](#) [SK33A-TP](#) [SK34A-TP](#) [SK34B-TP](#) [SMD1200PL-TP](#) [ACDBN160-HF](#) [SS3003CH-TL-E](#) [STPS30S45CW](#) [PDS3100Q-7](#) [GA01SHT18](#) [CRS10I30A\(Te85L,QM\)](#) [MBR1240MFST1G](#) [MBRB30H30CT-1G](#) [BAS28E6433HTMA1](#) [BAS 70-02L E6327](#) [HSB123JTR-E](#) [JANTX1N5712-1](#) [VS-STPS40L45CW-N3](#) [DD350N12K](#) [SB007-03C-TB-E](#) [SB10015M-TL-E](#) [SB1003M3-TL-E](#) [SK110-LTP](#)