

编号	Issue No. G.HPK.202112053
规格书版本号	A
客户版本号	A0

尊敬的 Messrs

## 规 格 书

### SPECIFICATIONS

产 品 类 型 Product type	导电高分子固体铝电解电容器 Aluminium electrolytic capacitors with conductive polymer solid electrolyte
产 品 系 列 Series	HPK

南通江海电容器股份有限公司

Nantong Jianghai Capacitor Co., Ltd.

地址：江苏省南通市平潮镇通扬南路79号

No.79 South Tongyang Road Pingchao Town

Nantong City Jiangsu Province PR China

TEL: 0086--0513--86726020 / FAX: 0086--0513--86571812

日 期 Date	批 准 Approved by	审 核 Checked by	制 定 Drawn by
2021.12.6	姚玉英	孙何欢	黄熊惑

承认栏 User	

## 目录 Contents

No.	项目 Item	页码 Page
1	适用范围 Scope	4
2	规格值 Specifications	4~5
3	尺寸 Dimensions	5
4	标志 Marking	6
5	构造 Structure	7
6	编码规则 Part number system	7
7	特性 Characteristics	8~12
8	包装 Packing	13
9	环保方面 Environmental	13
10	使用注意事项 Technical note	14~17



## 1. 适用范围 Scope

本规格书适用于 HPK 系列固体导电高分子铝电解电容器。

This specification is applicable to HPK series aluminum electrolytic capacitors with conductive polymer solid electrolyte.

## 2. 规格值 Specifications

No.	项目 Item	规格值 Specifications
1	额定电压 Rated voltage	6.3~25 V
2	额定容量 Rated capacitance	100~1500 $\mu$ F 20°C, 120Hz
3	尺寸 Case size	见规格表
4	容量允许偏差 Tolerance on rated capacitance	$\pm$ 20 %
5	浪涌电压 Surge voltage	UR $\times$ 1.15
6	漏电流 Leakage current	见规格表 20°C, After 2 minutes
7	损耗角正切 Tangent of loss angle ( $\tan\delta$ )	见规格表 20°C, 120Hz
8	等效串联电阻 ESR	见规格表 100 kHz
9	额定纹波电流 Rated ripple current	见规格表 125°C, 100 kHz
10	温度范围 Category temperature range	-55 to 125 °C
11	额定寿命 Lifespan	125 °C, 2000 h
12	备注 Remark	

纹波电流频率系数 Frequency coefficient for ripple current

频率 Frequency	120Hz $\leq f <$ 1kHz	1kHz $\leq f <$ 10kHz	10kHz $\leq f <$ 100kHz	100kHz $\leq f <$ 500kHz
系数 Coefficient	0.05	0.3	0.7	1.0

## 2.1 规格表 specification table

序号	额定电压 V	额定容量 $\mu$ F	外形尺寸	江海部品号	客户部品号	加工方式	DF(%) 20°C 120Hz	LC( $\mu$ A) 20°C 2min	ESR值 m $\Omega$	RC 纹波值 mArms	寿命 h
1	6.3	330	5*8	PCR0JPK331ME08LL20WP	/	长脚	12	415.8	15	1550	2000
2	10	1200	6.3*15	PCR1APK122MF15LL25WP	/	长脚	12	2400	19	2200	2000
3	16	560	8*11.5	PCR1CPK561MBABLL35WT	/	长脚	12	1792	16	2500	2000
4	16	560	8*11.5	PCR1CPK561MBABLL35WP	/	长脚	12	1792	16	2500	2000
5	16	1500	8*16	PCR1CPK152MB16LL35WP	/	长脚	12	4800	14	2700	2000
6	25	100	5*8	PCR1EPK101ME08LL20WP	/	长脚	12	500	36	1255	2000
7	25	470	6.3*14	PCR1EPK471MF14LL25WP	/	长脚	12	2350	17	2000	2000
8	25	680	6.3*16	PCR1EPK681MF16LL25WP	/	长脚	12	3400	17	2500	2000
9	25	150	5.5*9	PCR1EPK151MS09LL25WP	/	长脚	12	750	36	1255	2000

## 3. 尺寸 Dimensions

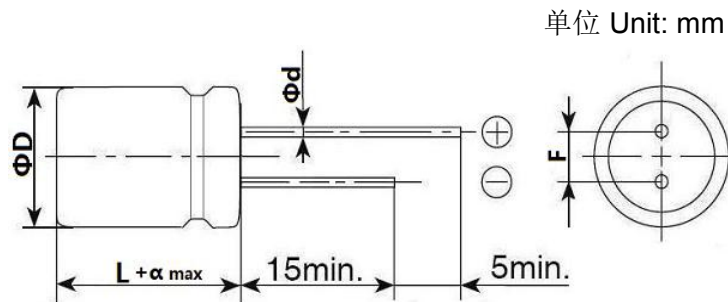

NO.	Code	$\Phi D \pm 0.5$	L	$\alpha_{max}$	$F \pm 0.5$	$\Phi d \pm 0.05$
1	E08	5	8	1	2	0.5
2	F15	6.3	15	1.5	2.5	0.5
3	BAB	8	11.5	1.5	3.5	0.6
4	BAB	8	11.5	1.5	3.5	0.6
5	B16	8	16	1.5	3.5	0.6
6	E08	5	8	1	2	0.5
7	F14	6.3	14	1.5	2.5	0.5
8	F16	6.3	16	1.5	2.5	0.5
9	S09	5.5	9	1	2.5	0.5

#### 4. 标志 Marking

颜色：红色 Color: Red (Example: HPK 6.3V470)

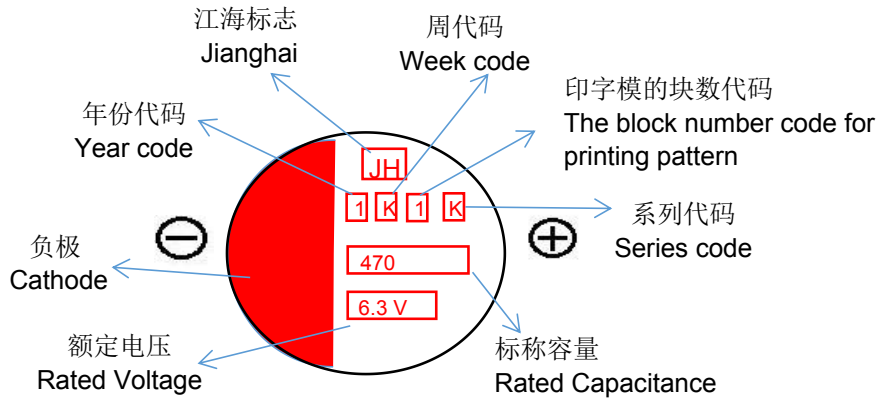

注：公司默认颜色为红色，如果客户有特殊颜色要求时，按客户所需颜色执行。

Note: The control marking color is red, and can be adjusted according to customer's demand.

#### 4.1 印字说明 Printed words

1) 江海标志: JH

2) 年份代码: 制造年份, 1位数字, 0~9表示, 如2021年为1, 每十年一轮换。

年份	2018	2019	2020	2021	2022	2023	2024	2025	2026	2027	2028	2029	2030
代码	8	9	0	1	2	3	4	5	6	7	8	9	0

3) 周代码: 制造周, 1位数字, 1~26周分别印为26个大写字母A、B、C、D到Z; 27~52周分别印为26个小写字母a、b、c、d到z。

周	1	2	3	4	5	6	7	8	9	10	11	12	13	14	15	16	17	18
代码	A	B	C	D	E	F	G	H	I	J	K	L	M	N	O	P	Q	R
周	19	20	21	22	23	24	25	26	27	28	29	30	31	32	33	34	35	36
代码	S	T	U	V	W	X	Y	Z	a	b	c	d	e	f	g	h	i	j
周	37	38	39	40	41	42	43	44	45	46	47	48	49	50	51	52		
代码	k	l	m	n	o	p	q	r	s	t	u	v	w	x	y	z		

4) 印字模块数代码: 第一块用1表示, 第二块用2表示, 第三块用3表示, 以此类推。

5) 系列代码

系列	HCN	HEN	HPN	HPNA	HGN	HEL	HCE	HSN	HCS	HEG	HPK	HPF	HCT
代码	1	2	3	4	5	6	7	8	9	G	K	P	T

6) 负极: 极性, 负极标志

7) 额定电压: 如额定电压6.3V印字为6.3V

8) 静电容量 (单位  $\mu\text{F}$ ), 如560  $\mu\text{F}$ 印字为560。

## 5. 构造 Construction

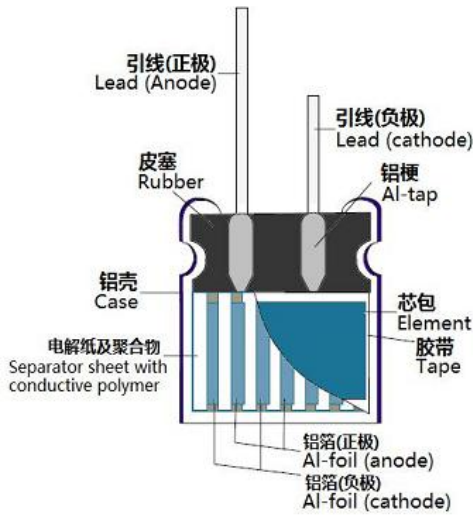

No.	成分 Compositions	
1	芯包 Element	正极箔 Anode foil
2		负极箔 Cathode foil
3		电解纸 Separator
4		胶带 Tape
5		聚合物 Polymer
6	皮塞 Rubber	
7	铝梗 Al-tap	
8	引线 Lead wires	
9	铝壳 Case	

## 6. 编码规则 Part number system

PC	R	0J		PK		331		M		E08	
电容类型 Capacitor type	端子形状 Terminal type	电压代码 Rated voltage		系列代码 Series code		容量代码 Capacitance code		容量偏差 Capacitance tolerance		尺寸代码 Dimension code	
PC =	R =	0J	6.3	PK	HPK	331	330	+20%	M	E08	5*8
聚合物电容 Polymer Capacitor	引线式 Radial	1C	16			561	560	-20%		BAB	8*11.5
		1E	25			152	1500			B16	8*16
						101	100			F14	6.3*14
						471	470			F15	6.3*15
						681	680			F16	6.3*16
						151	150			S09	5.5*9

LL	20		W	P	
引线形状 Lead Form	引脚/间距尺寸 Terminal / Pitch size		热收缩套管 Heat shrinkable sleeve	胶塞形状 Rubber plug shape	
长引脚 Long lead	代码 Code	间距 Pitch (mm)	涂层(无套管) Laminated	P	平皮塞 Flat rubber plug
	20	2.0		T	凸皮塞 Convex rubber plug
	35	3.5			
	25	2.5			

## 7. 特性 Characteristics

No.	项目 Item	特性 Characteristics	测试方法 Test method
1	漏电流 Leakage current	见规格表值 See specifications list	<p>保护电阻: 1,000 <math>\Omega</math>            施加额定电压2分钟            如果有异议, 请先进行电压处理            电压处理:            电容器应串联1000 <math>\Omega</math>电阻, 125 <math>^{\circ}\text{C}\pm 2^{\circ}\text{C}</math>下            施加额定电压2 h; 接着串联1<math>\Omega</math>/V的电阻在标准            大气压下放置12~24 h冷却至室温。            Series resistor: 1,000 <math>\Omega</math>            Applied rated voltage 2 minutes.            If this value is doubtful, performed the voltage            treatment.            Voltage treatment: The capacitor should be            serially attached to a protective 1,000 <math>\Omega</math>            resistor and d.c. voltage equivalent to the            rated voltage should be applied for 2h at 125  <math>^{\circ}\text{C}\pm 2^{\circ}\text{C}</math>. Next, after letting the capacitor cool to            room temperature, it should be discharged            through a resistor of approximately 1 <math>\Omega</math>/V and            then stored at standard atmospheric            conditions for 12 h to 24 h.</p>
2	电容量 Capacitance	见规格表值 See specifications list	<p>测量线路: 等效串联线路            频率: 120 Hz<math>\pm 10\%</math>            测量电压: <math>\leq 0.5</math> Vrms            Measuring circuit: Equivalent series circuit            Frequency: 120 Hz<math>\pm 10\%</math>            Measuring voltage: <math>\leq 0.5</math> Vrms</p>
3	损耗角正切 Tangent of loss angle ( $\tan\delta$ )	见规格表值 See specifications list	<p>测量温度: 20<math>^{\circ}\text{C}\pm 2^{\circ}\text{C}</math>            Measuring temperature: 20<math>^{\circ}\text{C}\pm 2^{\circ}\text{C}</math></p>
4	等效串联电阻 Equivalent Series Resistance (ESR)	见规格表值 See specifications list	<p>频率: 100 kHz<math>\pm 10\%</math>            测量电压: <math>\leq 0.5</math> Vrms, 测量温度: 20<math>^{\circ}\text{C}\pm 2^{\circ}\text{C}</math>            Frequency: 100 kHz<math>\pm 10\%</math>            Measuring voltage: <math>\leq 0.5</math> Vrms            Measuring temperature: 20<math>^{\circ}\text{C}\pm 2^{\circ}\text{C}</math></p>
5	可焊性 Solderability	<p>95%以上面积的浸渍表面应附着一            层光滑焊锡。            At least 95% of circumferential            surface of the dipped portion of            termination shall be covered with            new solder.</p>	<p>焊锡槽法            助焊剂: 约25%松香乙醇溶液, 焊料Sn-Ag-Cu            温度: 245<math>^{\circ}\text{C}\pm 3^{\circ}\text{C}</math>, 时间: 2<math>\pm 0.3</math>秒            Solder bath method            Flux: Rosin // Ethanol, About 25 wt%            245<math>^{\circ}\text{C}\pm 3^{\circ}\text{C}</math> for Sn-Ag-Cu solder            Duration: 2<math>\pm 0.3</math> seconds</p>

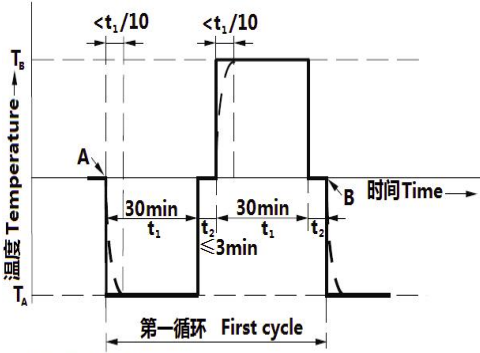

No.	项目 Item	特性 Characteristics		测试方法 Test method		
6	引出端强度 Robustness of terminations	外观 Appearance	无可见损伤, 标志清晰 No visible damage, Legible marking	拉力 Ua1: 试验时施加力量必须渐进(无冲击), 须于其轴向, 施加下表之拉力测试。 Tensile Ua1: With the body of a capacitor fixed, the load shall be applied to the lead wire termination in its draw out direction, gradually up to the specified value.		
				d (mm)	力 Force (N)	时间 Time
				0.3 < d ≤ 0.5	5	10 ± 1 s
				0.5 < d ≤ 0.8	10	
				弯曲 Ub: 将端子之轴向依垂直方向朝下放置, 在其尾端固定一重物, 此重物悬吊在端子之尾部。先使此元件倾斜成90°, 再使此重物使元件恢复原位, 这种操作称为一次“弯曲”。 Bending Ub: Suspend a weight corresponding to bending strength, bend the body through 90° and return it to the original position. Carry out these operations during 2 to 3 seconds and count it as one cycle. Carry out similar operations in the opposite direction and count it as two cycles.		
				d (mm)	力 Force (N)	
0.3 < d ≤ 0.5	2.5 (0.25kg)					
0.5 < d ≤ 0.8	5 (0.51kg)					
7	耐焊接热 Resistance to soldering heat	容量变化 Capacitance change	初始值的±5%以内 Within ±5% of the initial value	A) 焊锡槽法 温度: 260°C ± 5°C, 时间: 10 ± 1 秒 B) 烙铁方法 温度: 400°C ± 10°C 时间: 3 + 1/0 秒 * 热保护: 1.6 mm厚的环氧树脂板 A) Solder bath method Temperature: 260°C ± 5°C Duration: 10 ± 1 seconds B) Soldering iron method Temperature: 400°C ± 10°C Duration: 3 + 1/0 seconds Heat protector: t=1.6 mm glass-epoxy board.		
		损耗角正切 Tanδ	项目2的规定值以内 Within the value of item 2.			
		漏电流 Leakage current	项目2的规定值以内 Within the value of item 2.			
		外观 Appearance	无可见损伤, 标志清晰 No visible damage, Legible marking			

No.	项目 Item	特性 Characteristics		测试方法 Test method
8	振动 Vibration	容量 Capacitance	30分钟内，容量值相比初始值不应有明显变化。 Capacitance value shall not show drastic change compared to the initial capacitance when the value is measured within 30 minutes.	频率：10~55 Hz (间隔1分钟/ 10 ⇒ 55 ⇒ 10 Hz) 振幅：0.75 mm (总偏移 1.5 mm) 方向：X, Y, Z (3 向) 时间：2小时/向 (总6小时) 电容器如下图安装： Frequency: 10 to 55 Hz (1 minute interval / 10 ⇒ 55 ⇒ 10 Hz) Amplitude: 0.75 mm (Total excursion 1.5 mm) Direction: X, Y, Z (3 axes) Duration: 2 hours / axial (Total 6 hour) The capacitors are supported as the following figure:
		容量变化 Capacitance change	初始值的±5%以内 Within ±5% of the initial value	
		外观 Appearance	无可见损伤，标志清晰 No visible damage, Legible marking	
9	温度快速变化 Rapid change of temperature	容量变化 Capacitance change	初始值的±10%以内 Within ±10% of the initial value	施加电压：无加电 循环次数：5次 Applied voltage: Without load Cycle number: 5 cycles  <p>             A 第一循环的起点              B 第一循环的终点及第二循环的起点              A start of first cycle              B end of first cycle and star of second cycle              TA= -55 °C TB= 125 °C           </p>
		损耗角正切 Tanδ	项目2的规定值以内 Within the value of item 2.	
		漏电流 Leakage current	项目2的规定值以内 Within the value of item 2.	
		外观 Appearance	无可见损伤，标志清晰 No visible damage, Legible marking	

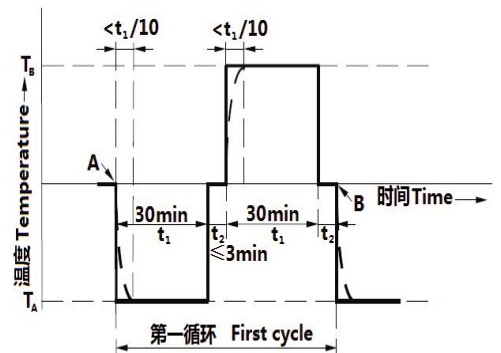
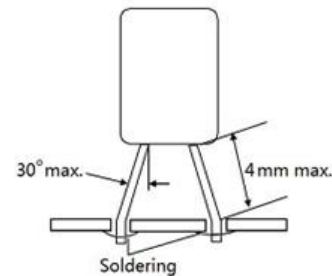

A 第一循环的起点  
 B 第一循环的终点及第二循环的起点  
 A start of first cycle  
 B end of first cycle and star of second cycle  
 TA= -55 °C TB= 125 °C

No.	项目 Item	特性 Characteristics		测试方法 Test method
10	高温存储 Shelf Life	容量变化 Capacitance change	初始值的±20%以内 Within ±20% of the initial value	温度 Temp : 125 ±2℃ 时间 Time : 1000+36 小时 电压处理: 在常温下电容器串联保护 电阻(1KΩ), 加额定电压30分钟, 放电 , 常温放置24~ 48小时后测量。  Condition :The DC rated voltage shall be applied across the, capacitor and its protective ,resistor (1KΩ) for 30 minutes The capacitor shall then be stored under, standard Atmospheric conditions for 24 ~ 48 hours.
		损耗角正切 Tanδ	≤2倍项目2的规定值 Within 2 times of the value of item 2.	
		漏电流 Leakage current	项目2的规定值以内 Within the value of item 2.	
11	耐久性 Endurance	容量变化 Capacitance change	初始值的±20%以内 Within ±20% of the initial value	温度: 125 ±2℃ 时间: 2000 +48/-0小时 施加电压: 额定电压 Temperature: 125 ±2℃ Duration: 2000 +48/-0h Applied voltage: Rated voltage
		损耗角正切 Tanδ	≤1.5倍项目2的规定值 Within 1.5 times of the value of item 2.	
		等效串联电阻 ESR	≤1.5倍项目2的规定值 Within 1.5 times of the value of item 2.	
		漏电流 Leakage curre	项目2的规定值以内 Within the value of item 2.	
		外观 Appearance	无可见损伤, 标志清晰 No visible damage,Legible marking	
12	稳态湿热 Damp heat, steady state	容量变化 Capacitance change	初始值的±20%以内 Within ±20% of the initial value	温度: 60±2℃ 相对湿度: 90 ~ 95% 时间: 1,000 + <sup>24</sup> / <sub>0</sub> 小时  Temperature: 60±2℃ Relative humidity: 90 to 95% Duration: 1,000 + <sup>24</sup> / <sub>0</sub> hours
		损耗角正切 Tanδ	≤1.5倍项目2的规定值 Within 1.5 times of the value of item 2.	
		等效串联电阻 ESR	≤1.5倍项目2的规定值 Within 1.5 times of the value of item 2.	
		漏电流 Leakage current	项目2的规定值以内 (通电处理后) Within the value of item 2. (After voltage treatment)	
		外观 Appearance	无可见损伤, 标志清晰 No visible damage,Legible marking	

No.	项目 Item	特性 Characteristics		测试方法 Test method
13	浪涌 Surge	容量变化 Capacitance change	初始值的±20%以内 Within ±20% of the initial value	温度：常温 施加电压：UR × 1.15 保护电阻：1 kΩ 循环次数：1,000 次
		损耗角正切 Tanδ	≤1.5倍项目2的规定值 Within 1.5 times of the value of item 2.	(A) 充电：30±5 秒 (B) 放电：5.5 分钟 (A) + (B)：1 个循环
		等效串联电阻 ESR	≤1.5倍项目2的规定值 Within 1.5 times of the value of item 2.	Temperature: Normal temperature Applied voltage: UR × 1.15 Protective resistor: 1 kΩ
		漏电流 Leakage current	≤项目2的规定值 Within the value of item 2.	Cycle number: 1,000 cycles (A) Charge: 30±5 seconds (B) Discharge: 5.5 minutes
		外观 Appearance	无可见损伤，标志清晰 No visible damage, Legible marking	(A) + (B): 1 cycle

14	高、低温特性 Characteristics at high and low temperature	<table border="1"> <thead> <tr> <th>阶段 step</th> <th>温度 Temperature</th> <th>测试项目 Item</th> <th>特性 Characteristics</th> </tr> </thead> <tbody> <tr> <td rowspan="3">1</td> <td rowspan="3">+20°C±2°C</td> <td>电容量 Capacitance</td> <td>初始限定值以内 Within the initial specified value</td> </tr> <tr> <td>损耗角正切 Tangent of loss angle</td> <td>初始限定值以内 Within the initial specified value</td> </tr> <tr> <td>阻抗(100KHz) Impedance(Z)</td> <td>初始限定值以内 Within the initial specified value</td> </tr> <tr> <td>2</td> <td>-55°C±3°C 放置两小时</td> <td>阻抗(100KHz) Impedance(Z)</td> <td><math>Z(-55^{\circ}\text{C})/Z(+20^{\circ}\text{C})\leq 1.25</math></td> </tr> <tr> <td>3</td> <td>+20°C±2°C</td> <td>-</td> <td>-</td> </tr> <tr> <td rowspan="2">4</td> <td rowspan="2">+125°C±2°C 放置两小时</td> <td>漏电流 Leakage current</td> <td>≤12.5倍初始限定值 ≤12.5 times of the initial specified value</td> </tr> <tr> <td>阻抗(100KHz) Impedance(Z)</td> <td><math>Z(+125^{\circ}\text{C})/Z(+20^{\circ}\text{C})\leq 1.25</math></td> </tr> <tr> <td rowspan="2">5</td> <td rowspan="2">+20°C±2°C</td> <td>容量变化 Capacitance change</td> <td>步骤1的±5%以内 Within ±5% of the Step 1</td> </tr> <tr> <td>损耗角正切 Tangent of loss angle</td> <td>初始限定值以内 Within the initial specified value</td> </tr> </tbody> </table>				阶段 step	温度 Temperature	测试项目 Item	特性 Characteristics	1	+20°C±2°C	电容量 Capacitance	初始限定值以内 Within the initial specified value	损耗角正切 Tangent of loss angle	初始限定值以内 Within the initial specified value	阻抗(100KHz) Impedance(Z)	初始限定值以内 Within the initial specified value	2	-55°C±3°C 放置两小时	阻抗(100KHz) Impedance(Z)	$Z(-55^{\circ}\text{C})/Z(+20^{\circ}\text{C})\leq 1.25$	3	+20°C±2°C	-	-	4	+125°C±2°C 放置两小时	漏电流 Leakage current	≤12.5倍初始限定值 ≤12.5 times of the initial specified value	阻抗(100KHz) Impedance(Z)	$Z(+125^{\circ}\text{C})/Z(+20^{\circ}\text{C})\leq 1.25$	5	+20°C±2°C	容量变化 Capacitance change	步骤1的±5%以内 Within ±5% of the Step 1	损耗角正切 Tangent of loss angle	初始限定值以内 Within the initial specified value
		阶段 step	温度 Temperature	测试项目 Item	特性 Characteristics																																
		1	+20°C±2°C	电容量 Capacitance	初始限定值以内 Within the initial specified value																																
				损耗角正切 Tangent of loss angle	初始限定值以内 Within the initial specified value																																
				阻抗(100KHz) Impedance(Z)	初始限定值以内 Within the initial specified value																																
		2	-55°C±3°C 放置两小时	阻抗(100KHz) Impedance(Z)	$Z(-55^{\circ}\text{C})/Z(+20^{\circ}\text{C})\leq 1.25$																																
		3	+20°C±2°C	-	-																																
		4	+125°C±2°C 放置两小时	漏电流 Leakage current	≤12.5倍初始限定值 ≤12.5 times of the initial specified value																																
				阻抗(100KHz) Impedance(Z)	$Z(+125^{\circ}\text{C})/Z(+20^{\circ}\text{C})\leq 1.25$																																
		5	+20°C±2°C	容量变化 Capacitance change	步骤1的±5%以内 Within ±5% of the Step 1																																
				损耗角正切 Tangent of loss angle	初始限定值以内 Within the initial specified value																																

## 8. 包装 Packing

内外盒尺寸及数量 Size and Quantity of inbox and outbox

φD*L	Small box		Inner box		Outer box	
	Size	Qty(pcs)	Size	Qty(pcs)	Size	Qty(pcs)
5*8	174*70*70	900	390*184*240	13500	410*410*255	27000
8*11.5	174*70*70	400	390*184*240	6000	410*410*255	12000
8*16	174*70*70	200	390*184*240	3000	410*410*255	6000
6.3*14	174*70*70	500	390*184*240	7500	410*410*255	15000
6.3*15	174*70*70	400	390*184*240	6000	410*410*255	12000
6.3*16	174*70*70	400	390*184*240	6000	410*410*255	12000
5.5*9	174*70*70	800	390*184*240	12000	410*410*255	24000

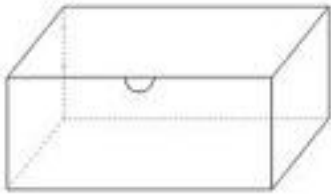

Small box

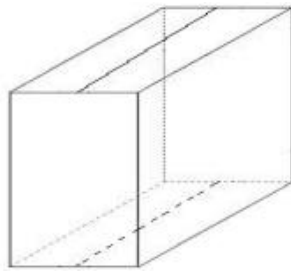

Inner box

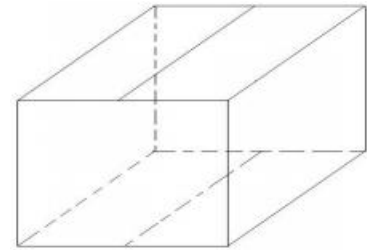

Outer box

## 9. 环保方面 Environmental

符合欧盟RoHS 2002/95/EC标准。RoHS 2002/95/EC compliant.

符合无卤素IEC 61249-2-21:2003标准。Halogen-free, IEC 61249-2-21:2003 compliant.

溴、氯含量分别小于 900 ppm，且溴与氯的含量总和小于 1,500 ppm。

The maximum total halogens contained in the resin plus reinforcement matrix is 1,500 ppm with a maximum chlorine of 900 ppm and maximum bromine being 900 ppm.

## 11. Technical note 使用注意事项

As aluminum solid capacitor with conductive polymer is different as the common capacitors which use electrolyte as cathode. Please note the following points in order to take full advantages of the aluminum solid capacitor with conductive polymer and ensure the most stable quality possible.

固体铝电解电容器具有不同于一般电解液作为阴极的铝电解电容器。为使导电性高分子铝电解电容器在电路中发挥其优越的性能，在使用中请特别注意以下内容。

### Crucial precautions 使用中需要特别注意的事项

<p>1. Polarity</p> <p>The solid aluminum electrolytic capacitor with positive and negative electrodes. Do not reverse the polarity when using. If happened, increased leakage current or a decreased life span may result.</p>	<p>1. 极性</p> <p>导电性高分子型固体铝电解电容器的引出端子有正负极之分。 在电路中使用切勿将正负极接反，否则将有导致电容器漏电流增加并将严重影响电容器的使用寿命。</p>
<p>2. Prohibited circuits</p> <p>The leakage current may become greater even if the soldering conditions adhere to the specification requirements. Therefore, do not use the capacitors in the following circuits because trouble or failure may occur.</p> <p>a) High impedance circuits b) Coupling circuits c) Time constant circuits d) Do not use the capacitors in circuits except those above if changes in the leakage current affects circuit operations.</p>	<p>2. 不推荐使用的电路</p> <p>导电性高分子型固体铝电解电容器在电路使用中由于焊接等原因会导致漏电流增大，因此不推荐应用于以下电路。</p> <p>a) 高阻抗电路 b) 耦合电路 c) 时间常数电路 d) 受漏电流影响较大的电路</p>
<p>3. Compliance with rated performance</p> <p>The aluminum solid capacitor with conductive polymer must be used under the rated voltage. Over-voltage exceeding the rated voltage should not be applied since it may cause a short circuit.</p>	<p>3. 禁止在过电压状态下使用</p> <p>导电性高分子型固体铝电解电容器必须在低于额定工作电压下使用。 瞬间的超过额定电压的过电压可能会导致电容器的短路。</p>
<p>4. Considerations when soldering</p> <p>The soldering conditions are to be within the range prescribed in specifications. If the specifications are not followed, there is a possibility of the cosmetic deflection, the intensive increase of leakage current, and the capacitance reduction.</p>	<p>4. 电容器焊接时的注意事项</p> <p>电容器的焊接条件请在本公司所规定的范围内进行。 强烈的焊接条件，可能会造成电容器电气性能的劣化甚至外观不良，严重时更会导致电容器漏电流的急剧增加和容量急剧下降。</p>
<p>5. Things to be noted before mounting</p> <p>The aluminum solid capacitors with conductive polymer is sealed well, because of sealing the rubble may protrude, please conform to the dimensional tolerance stipulated in the specifications.</p>	<p>5. 线路板焊接时的注意事项</p> <p>导电性高分子型固体铝电解电容器的封口皮塞具有较好的密封效果，由于封口的原因皮塞可能会有一定程度的鼓起，电路设计时请考虑本公司规格书的L尺寸和引线的位置公差范围。</p>

## Points for attention 用户使用注意事项

1. Considerations when circuit design	1. 电路设计的注意事项
(a) Confirm the characteristic before using	(a) 额定电性能的使用确认
Please confirm the using and mounting conditions before circuit design. Please confirm the using and mounting conditions which are to be within the range prescribed in the specification.	在电路设计前, 请先确认电容器的使用及安装环境, 请在本公司的技术手册或者规格书的规定条件范围内正确使用。
(b) Operating temperature and ripple current	(b) 使用温度和纹波电流
Please confirm operating temperature is in the specification. Do not apply current that exceeds the rated ripple current. When excessive ripple current is applied, the solid capacitor may result in shorter life due to the internal heat increases.	使用温度请设定在规格书规定的范围之内。 使用电容器过程中切勿施加超过额定纹波电流的电流。如有此现象的发生将会导致电容器内部急剧发热而严重缩短电容器的使用寿命。
(c) leakage current	(c) 漏电流
Heat pressure from soldering and mechanical stress from transportation may cause the leakage current to become large. In such a case, leakage current will gradually decreased by applying voltage less than or to the rated voltage at a temperature within the upper category temperature.	对于高温无负荷、高温高湿无负荷及温度急剧变化等试验也会导致漏电流的增大。 这种情况下, 在最高使用温度范围内施加额定使用电压, 漏电流会有一定程度的降低。
(d) Applied voltage when circuit design	(d) 电路设计时的施加电压
It can be applied with the rated voltage Sum of the DC voltage value and the ripple voltage peak value must not exceed the rated voltage. When DC voltage is low, negative ripple voltage peak value must not become a reverse voltage that exceeds 10% of the rated voltage. Using the capacitors within 20% of the rated for applications which may cause the reserve voltage during the transient when the power is turned off or the source is switched.	可以施加100%的额定电压。请在直流电压与纹波电压的最大值不超过额定电压的范围内使用。直流电压偏低时, 纹波电压的负的最大值不能超过额定电压的10%的反向电压。在切断电源等造成的过渡现象中产生的反电压, 应在额定电压的20%以内使用。
(e) Capacitor insulation	(e) 电容器的绝缘性
Insulation in the laminate resin is not guaranteed. Be sure to completely separate the case, negative lead terminal, positive lead terminal and PC patterns will each other.	电容器的表面喷塑涂层不保证完全绝缘。使用电容器时请将外壳、负极引线、正极引线与周围组件之间的线路完全分开。
(f) Operating environmental restrictions	(f) 工作环境限制
Do not use the capacitors in the following environments: (1)Places where water, salt water, or oil can directly fall on it. (2)Places filled with noxious gas such as hydrogen sulfide, sulfide acid, chlorine, ammonia, etc. (3)Place susceptible to zone, ultraviolet rays and radiation.	电容器在下列环境中禁止使用: (1)在有水、卤水、油的地方 (2)充满有害气体的地方, 如硫化氢、亚硫酸、氯气、氨气等 (3)容易受臭氧氧化、紫外线及放射线辐射的地方
(g) others	(g) 其它
Design circuits after checking the following: Electric characteristics are affected by temperature and frequency fluctuations. Design circuits after checking the following items.	设计电路前请先确认以下内容: 电容器的电性能会受到温度和频率的影响, 在设计前请先确认波动量。

2. Mounting precautions	2. 安装注意事项
(a) Considerations before mounting	(a) 安装前的注意事项
Do not reuse the capacitors that have been assembled and energized. Leakage current may increase when the capacitors are stored for a period of time. In this case, we recommend that you apply the rated voltage for 1 hour at 60~70°C with a resistor load of 1kΩ.	使用过的电容器不能再使用。 长期保存的电容器其漏电流会有不同程度的升高，此情况下请通过1kΩ的电阻进行施加额定电压处理。 处理方法：在60~70°C温度下施加额定电压1h。
(b) Considerations when mounting	(b) 安装时的注意事项
Mount after checking the capacitance and the rated voltage, please confirm the polarity. Do not drop the capacitors on the floor. Do not use the capacitors that have been dropped. Mount after checking that radial lead types of the capacitors terminal pitch and diameter of PCB holes.	安装时注意电容器的标称容量和额定电压，并确认极性。 安装过程中切勿将电容器掉落地面，此电容器不能再使用，安装过程中防止电容器变形。 安装前请确认电容器的引线间距是否与线路板孔间隔吻合。
(c) Soldering with a soldering iron	(c) 电烙铁焊接
Set the soldering temperature and time in the specifications. Do not subject the capacitors itself to excessive stress when soldering. Do not let the tip of the soldering iron touch the capacitors itself. The leakage current value after soldering may increase a little, from a few μA to several hundred μA, depending on the soldering conditions (preheating and solder temperature and time, PCB material and thickness, ect.). The leakage current can be reduced through self-repair by applying voltage.	焊接温度、时间等请保持在本公司规格书规定的范围内。 焊接时不要给电容器施加过度的应力，通电的电烙铁不要触及电容器本身。 焊接后电容器的漏电流因焊接预热条件、焊接温度、时间、线路板的材质及材质不同而发生很大的变化，几十甚至几百微安，但是在施加额定电压后处于稳定状态时电容器由于自愈能力而会使其漏电流逐渐减小。
(d) Handling after soldering	(d) 后处理
Do not subject the capacitors itself to excessive stress after soldering Do not tilt, bend or twist the capacitors after it has been soldered on the PCB.	电容器焊接在线路板后，请不要施加外力。 禁止将电容器倾斜、弯折、扭曲。
3. Precautions with completed board	3. 电容器在设备中安装时的注意事项
(1)Do not touch the lead terminals of the capacitors directly. (2)Do not use electric conductive to cause short circuit between the capacitors lead terminal. Do not subject the capacitors to conductive solutions such as acid and alkaline water solutions. (3)Check the installation environment of the board the capacitor is installed in. Age the board at conditions that fall bellow the capacitors ratings.	(1)安装过程中切勿直接接触电容器的引线端子。 (2)禁止将电容器的正负极之间用导线短路，不要将导电性的酸性或碱性溶液洒落在电容器表面。 (3)安装前确认电容器在设备中的安装环境。 (4)设备的试验温度要在电容器的额定范围内使用。
4. Contingency failure	4. 意外情况的处理
The electrolyte, electrolytic paper, sealing rubber, and sleeve used in the capacitors are all combustible. When the current is extraordinarily large after a short circuit, in the worst case, the shorted-out section in the lead terminal or inside the capacitor may ignite the rubber. Pay attention to the capacitor mounting method, mounting position, pattern design ect	导电性高分子型固体铝电解电容器组成材料包括电解质、电解纸、皮塞和套管属于可燃性物质，电容器短路后电流值急剧增加，导致引线端子和电容器内部短路部分会产生电火花，情况严重时会引起皮塞和套管燃烧，所以在电路设计中应对电容器的安装方法和安装位置谨慎对待。



<p>5. Storage conditions</p> <p>(1)Do not store the capacitor at high temperature and high humidity. Store it in a location that is not subject to direct sunlight and that has temperatures less than 5 to 35°C and a relative humidity less than 75%.</p> <p>(2)To keep good solder ability, store in its plastic under-shipment condition. Sealed up in specifically designed aluminum laminate bags to prevent deterioration in characteristic and solder ability before and after resulting from moisture absorption.</p> <p>(3)To keep good solder ability, store radial lead types packed in bags for not more than one year. Radial lead types with SMD type for not more than one year.</p> <p>(4)Open the bags just before mounting, and use up all products once opened. In case of leftovers, put the products packed in bags and sealed up with adhesive tape.</p> <p>(5)Do not store the capacitors in damp conditions such as water, salt spray, or oil.</p> <p>(6)Do not store the capacitor in places filled with hydrogen sulfide, sulfurous acid, chlorine, ammonia, etc.</p> <p>(7)Do not store the capacitors in places susceptible to zone, ultraviolet rays and radiation.</p>	<p>5. 电容器的保管条件</p> <p>(1)导电性高分子型固体铝电解电容器的保存要避免高温、高湿的环境，并避免阳光直射。 常温常湿(一般情况温度为35℃以下，湿度保持在75%RH以下)</p> <p>(2)为保持电容器具有良好的可焊性，应在产品出厂状态下(塑料袋包装)保管。 为防止吸潮而导致焊接性劣化，产品出厂时密封在专用的包装袋内。</p> <p>(3)为保持良好的焊接性，引线式产品保管期限为(购入后)一年，SMD型的保管期限为(购入后)一年，SMD型产品打开包装后，需在4周内使用完。</p> <p>(4)使用时，应在即刻安装前开封，开封后尽量全部用完。出现剩余时，散装产品重新放入原包装袋内，并用胶带封好开口部分。</p> <p>(5)不要将电容器直接保管在有水、卤素及有油等有机物的环境中。</p> <p>(6)不要将电容器保存在充满有害气体环境中，如硫化氢、亚硫酸、氯气、氨气等。</p> <p>(7)不要将电容器保存在易受臭氧氧化、紫外线及放射线辐射的环境中。</p>
---	---

<p>6. About RoHS Directive</p> <p>RoHS Directive [Restriction of the use of certain hazardous substances in electrical and electrical and electrical equipment] RoHS aims to improve the regulations for hazardous substances in electrical and electrical equipment, and to minimize the hazardous effects on environment and to people's health from the production process up to and including the disposal process. RoHS prohibits the use of 6 substances including cadmium, lead, hexavalent chromium, mercury, polybrominated biphenyls (PBBs), and polybrominated diphenyl (PBDEs).</p>	<p>6. About RoHS Directive 6. 关于RoHS指令</p> <p>[RoHS指令] [电子及电子设备中某些危险物质使用的限制] RoHS指令是为了减少电子及电子设备中有毒有害物质的使用，而降低这些物质对人类环境和人体健康的危害而采取的相应程序。 RoHS指令中限制使用的6种有毒有害物质包括镉(Cd)、铅(Pb)、汞(Hg)、六价铬(Cr6+)、多溴联苯(PBB)、多溴二苯醚(PBDE)。 如有特殊需要，可与我公司联系。</p>
---	--

## X-ON Electronics

Largest Supplier of Electrical and Electronic Components

*Click to view similar products for [Aluminium Organic Polymer Capacitors](#) category:*

*Click to view products by [Jianghai](#) manufacturer:*

Other Similar products are found below :

[750-1809](#) [SEAU0A0102G](#) [MAL218297003E3](#) [APA0609471M006R](#) [APA0807561M004R](#) [APA0809331M016R](#) [APA0809561M010R](#)  
[APA0809821M004R](#) [APA0812102M006R](#) [APA0812122M004R](#) [APA0812471M016R](#) [APA0812561M016R](#) [HHXD630ARA330MJA0G](#)  
[HHXD350ARA270MF61G](#) [HHXD350ARA220ME61G](#) [HHXD350ARA101MHA0G](#) [HHXD500ARA101MJA0G](#) [HHXD250ARA101MF80G](#)  
[APXJ200ARA151MF61G](#) [HHXE250ARA331MJA0G](#) [RS81C271MDN1CG](#) [PM101M016E058PTR](#) [PM101M025E077PTR](#)  
[SPZ1EM221E10P25RAXXX](#) [APSE2R5ETD821MF08S](#) [SPZ1EM681F14O00RAXXX](#) [SPZ1AM102F11000RAXXX](#)  
[SPV1VM471G13O00RAXXX](#) [SPV1VM101E08O00RAXXX](#) [SPZ1VM821G18O00RAXXX](#) [SPV1HM331G15O00RAXXX](#)  
[SPZ1HM221G12O00RAXXX](#) [SPZ1CM471E11O00RAXXX](#) [SVZ1EM221E09E00RAXXX](#) [PM101M035E077PTR](#) [HV1A227M0605PZ](#)  
[HV1C107M0605PZ](#) [HV1C227M0607PZ](#) [HV1H107M0810PZ](#) [149EC920](#) [149EC921](#) [118EC222](#) [118EC229](#) [118EC247](#) [118EC333](#)  
[118EC220](#) [118EC221](#) [118EC225](#) [118EC235](#) [118EC227](#)