

5.5W Anti-Clipping Mono Class D Audio Amplifier with Boost Converter

FEATURE

- Anti-Clipping Function (ACF)
- Filter-less Modulation, Eliminating Output Filter
- Output Power
 - 5.5W ($V_{BAT}=4.2V$, $PVDD = 6.5V$, $R_L=4\Omega$, $THD+N=10\%$)
 - 3.0W ($V_{BAT}=4.2V$, $PVDD = 6.5V$, $R_L=8\Omega$, $THD+N=10\%$)
- Power Supply
 - Boost Input V_{BAT} : 2.5V to 5.5V
 - Boost Output $PVDD$: V_{BAT} to 7.0V
- Adjustable BOOST Output Voltage
- Class AB / Class D
- Over Current Protection, Thermal Protection, Low voltage malfunction prevention function included
- Pb-Free Packages , SOP8L-PP

APPLICATIONS

- | | |
|----------------------------|---------------------|
| • Bluetooth Speakers | • Portable Speakers |
| • 2.1 Channel Speakers | • Megaphone |
| • iphone/ipod/ipod docking | • MP4/GPS |
| • Tablet PC/Note Book | • Smart Phones |
| • LCD TV/Monitor | • Portable Gamers |

GENERAL DESCRIPTION

HT8691 integrates a boost converter with a filter-less stereo class D audio power amplifier to provide 5.5W continuous power into a 4Ω speaker when operating from a Li-battery voltage boosted to 6.5V. Meanwhile, the boost output voltage is adjustable.

HT8691 features Anti-Clipping Function (ACF) which detects output signal clip due to the over input signal and suppresses the output signal clip automatically. Also, the ACF function can adapt the output clip caused by power supply voltage down with battery. It can significantly improve the sound quality, creating a very comfortable musical enjoyment, and to protect the speakers from overload damage. It also supplies ACF OFF mode.

Class AB amplifier mode is also available for HT8691. Once the EMI Interference from class D and Boost Converter becomes an annoying problem, HT8691 can be changed into Class AB mode.

HT8691 has a filter-less modulation circuit which directly drives speakers while realizes low distortion and low noise characteristics. Thanks to filter-less, circuit design with fewer external parts can be made in portable applications.

HT8691 has the independent Shutdown function which can minimize the power consumption at standby and MUTE function. As for protection function, over current protection function for speaker output terminals, over temperature protection function, and low supply voltage malfunction preventing function are also prepared.

TYPICAL APPLICATION

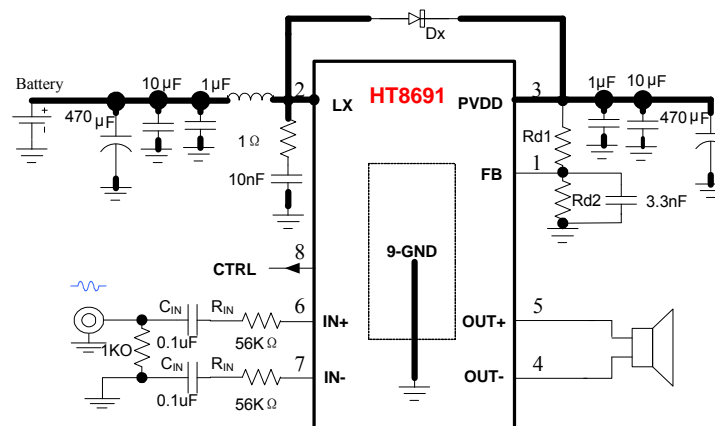

■ TERMINAL CONFIGURATION

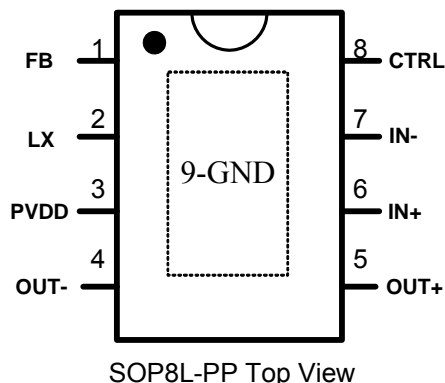

■ TERMINAL FUNCTION ^{*1}

SOP Terminal No.	Name	I/O	ESD Protection	Function
1	FB	I	PN	Regulator Feedback Input
2	LX	I	-	Internal Switch Input
3	PVDD	Power	PN	Boost Converter Output Voltage and Power Supply
4	OUT-	O	-	Negative Output Terminal (BTL-)
5	OUT+	O	-	Positive Output (BTL+)
6	IN+	I	PN	Positive Input Terminal (differential +)
7	IN-	I	PN	Negative Input Terminal (differential -)
8	CTRL	I	PN	Shutdown and ACF Control Terminal
9	GND	GND	PN	Power Ground

*1 I: Input O: Output

■ ORDERING INFORMATION

H
T
8
6
9
1
XX

Package type

Part Number	Package Type	Marking	Operating Temperature Range	MOQ/Shipping Package
HT8691SP	SOP8L-PP	HT8691SP B##### ^{*2}	-40°C ~ 85°C	Tape 100PCS

*2: ##### is production track code.

ELECTRICAL CHARACTERISTIC
Absolute Maximum Ratings *3

Item	Symbol	Min.	Max.	Unit
BOOST converter output voltage and Power supply voltage range	PVDD	-0.3	7.8	V
Input terminal voltage range (IN+, IN-)	V _{IN}	-0.6	PVDD+0.6	V
Input terminal voltage range (except IN+, IN-)	V _{IN}	-0.3	PVDD+0.3	V
Operating Ambient Temperature	T _A	-40	85	°C
Junction Temperature	T _J	-40	150	°C
Storage Temperature	T _{STG}	-50	150	°C

*3: Absolute Maximum Ratings is values which must not be exceeded to guarantee device reliability. With a system in which supply voltage might exceed supply voltage of PVDD/GND, external diodes are recommended to be used to assure that the voltage does not exceed the absolute maximum rating.

Recommended Operating Condition

Item	Symbol	Conditions	Min.	Typ.	Max.	Unit
BOOST converter output voltage and Power supply voltage range *4	PVDD		V _{BAT}	6.5	7.5	V
Operating Ambient Temperature	T _a		-40	25	85	°C
Speaker Impedance	R _L	SOP8L-PP		4		Ω

*4: The rising time of PVDD should be more than 1μs.

Electrical Specification *5

Item	Symbol	Conditions	Min.	Typ.	Max.	Unit	
BOOST Converter							
Boost converter output voltage	PVDD		V _{BAT}	6.5	7.5	V	
Boost converter frequency	f _{SW}			410		kHz	
Boost converter input current limit	I _{LIMITRIP}			2.3		A	
Class D Channel V _{SS} =0V, V _{BAT} =3.6V, R _{IN} = 56K, T _a =25°C, C _{IN} =0.1uF, ACF-Off mode, unless otherwise specified							
Carrier clock frequency	f _{PWM}			410		kHz	
Over current protection	I _{max}				5	A	
System Gain	A _{V0}	R _{IN} =56 kΩ		26		dB	
Start-up time (power-on or shutdown release)	t _{STUP}			280		ms	
ACF attenuation gain	A _a		-16		0	dB	
Consumption current in shutdown mode	I _{SD}	CTRL=V _{SS}		25		μA	
PVDD = 6.5V							
Output Power	P _O	R _L =4Ω	V _{BAT} =4.2V, f=1kHz, THD+N=10%		5.3	W	
		R _L =8Ω			3.0		
		R _L =4Ω		V _{BAT} =4.2V, f=1kHz, THD+N=1%			4.3
		R _L =8Ω					2.5
Total Harmonic Distortion plus Noise	THD+N	P _O =0.1W	R _L =4Ω, f=1kHz		0.13	%	
		P _O =1.0W			0.10	%	
		P _O =3.0W			0.15	%	
Output Noise	V _N	f=20Hz~20kHz, A weighted, A _v =26dB		150		μV _{rms}	
Signal to Noise Ratio	SNR	A weighted, A _v =26dB, THD+N = 1%		90		dB	
Output offset voltage	V _{OS}			±2		mV	
Efficiency (Class D + Boost)	η	V _{BAT} =3.6V, R _L =4Ω+22uH, THD+N = 10%		74		%	

		$V_{BAT}=3.6V$, $R_L=8\Omega+33\mu H$, THD+N = 10%		80		%
Quiescent current	I_{BAT}	No Load	Input Grounded	20		mA
		With Load* ⁶		20		mA
Maximum Input Signal	V_{INmax}	$f_{IN} = 1kHz$, THD+N ≤ 10%, ACF ON		1.2		V _{rms}
Class AB Channel⁷ $V_{SS}=0V$, $V_{BAT} = 3.6V$, $A_v=20dB$, $T_a=25^\circ C$, $C_{IN}=0.1\mu F$, unless otherwise specified						
Output Power	P_o	$R_L=4\Omega$, $V_{BAT}=3.6V$	$f=1kHz$, THD+N=10%	1.3		W
		$R_L=4\Omega$, $V_{BAT}=4.2V$		1.8		
		$R_L=4\Omega$, $V_{BAT}=5.0V$		2.65		W
		$R_L=4\Omega$, $V_{BAT}=3.6V$	$f=1kHz$, THD+N=1%	1.0		W
		$R_L=4\Omega$, $V_{BAT}=4.2V$		1.5		
		$R_L=4\Omega$, $V_{BAT}=5.0V$		2.1		W
Total Harmonic Distortion plus Noise	THD+N	$P_o=0.01W$	$R_L=4\Omega$, $f=1kHz$	0.12		%
		$P_o=0.1W$		0.1		%
Output Noise	V_N	$f=20Hz\sim 20kHz$, A weighted, $A_v=20dB$		75		μV_{rms}
Signal to Noise Ratio	SNR	A weighted, $A_v=20dB$, THD+N = 1%		90		dB
Output offset voltage	V_{OS}			± 4		mV
Efficiency	η	$R_L=4\Omega+22\mu H$, THD+N = 10%		70		%
		$R_L=8\Omega+33\mu H$, THD+N = 10%		74.5		%
Quiescent current	I_{BAT}	No Load	Input Grounded	20		mA
		With Load		20		mA
System Gain	A_{V0}	$R_{IN}=56 k\Omega$		20		dB
Start-up time (power-on, shutdown release, or switch from Class D to Class AB)	t_{STUP}			270		ms
Digital Input/Output						
ACF-Off (Class D) mode setting threshold voltage	V_{MOD1}			$0.75 \times$ PVDD		PVDD V
ACF ON (Class D) mode setting threshold voltage	V_{MOD2}			$0.50 \times$ PVDD		$0.60 \times$ PVDD V
Class AB mode setting threshold voltage* ⁸	V_{MOD3}			$0.15 \times$ PVDD		$0.35 \times$ PVDD V
SD mode setting threshold voltage	V_{MOD4}			0		$0.06 \times$ PVDD V
SD wake up voltage	V_{CTRL_ON}			0.8		
Internal pull-down Resistor of CTRL	R_{CTRL}	Class D		125		K Ω
		Class AB		$+\infty$		
MISCELLANEOUS						
V_{BAT} start-up threshold voltage	V_{UVLH}			2.5		V
V_{BAT} shut-down threshold voltage	V_{UVLL}			2.3		V

*5: Depending on parts and pattern layout, characteristics may be changed.

*6: 40hm resistor and 22uH coil are used as an output load in order to simulate a speaker.

*7: In Class AB amplifier mode, boost converter is shutdown automatically. Due to the schottky rectifier, the voltage of PVDD terminal can be lower than V_{BAT}, depending on the forward voltage of the rectifier.

*8: ACF ON mode is only available in Class D amplifier mode.

TYPICAL OPERATING CHARACTERISTICS
Class D Channel

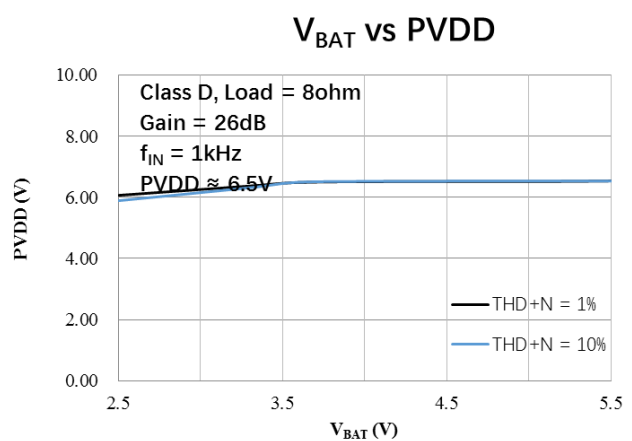
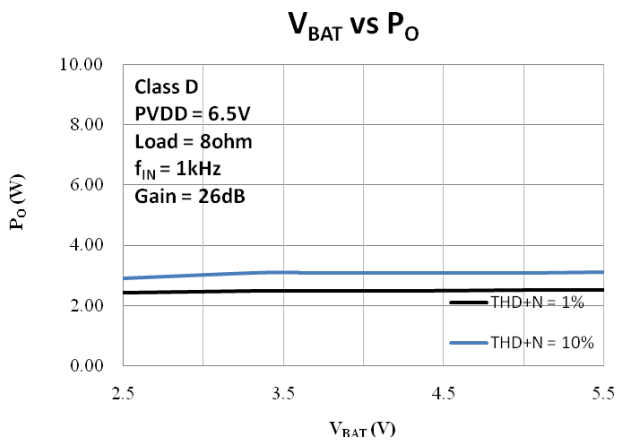
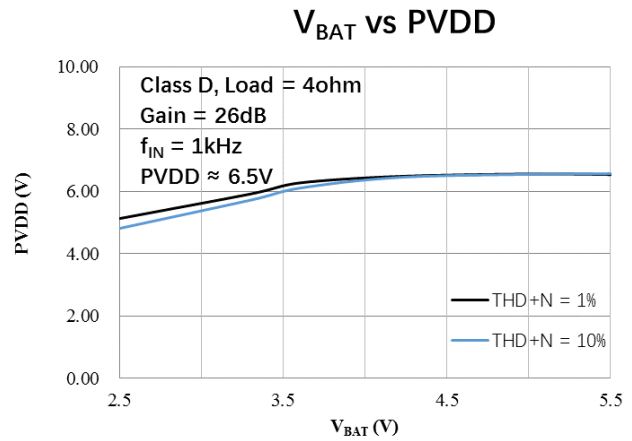
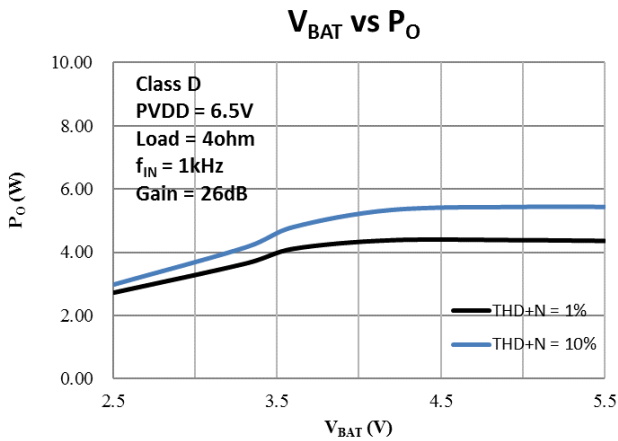
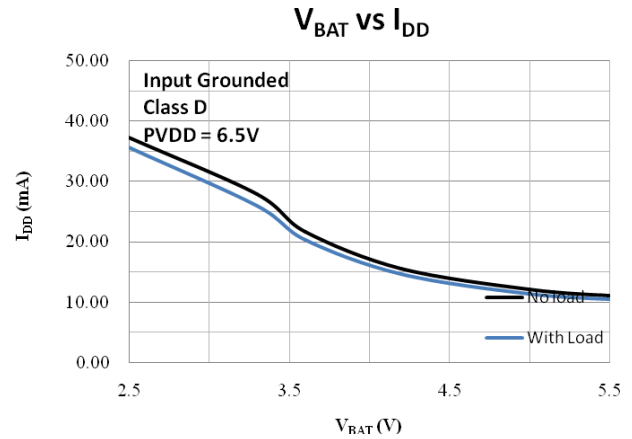
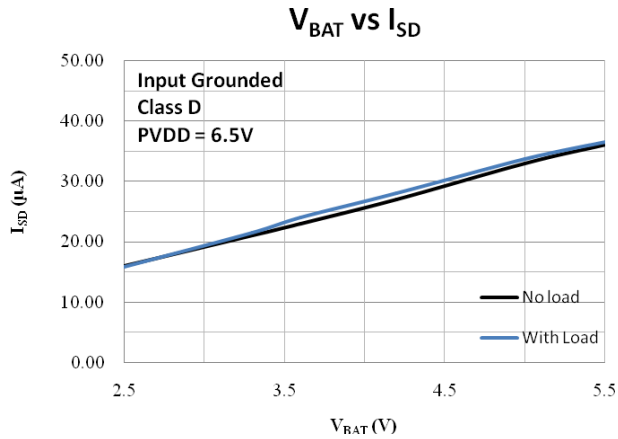
 Condition: Class D mode, $V_{BAT} = 3.6V$, $PVDD = 6.5V$, $f_{IN} = 1kHz$, $R_{IN} = 56k$, Gain = 26dB, ACF off, Output = Load + Filter, Load = 4ohm, Filter = 100ohm + 47nF, unless otherwise specified

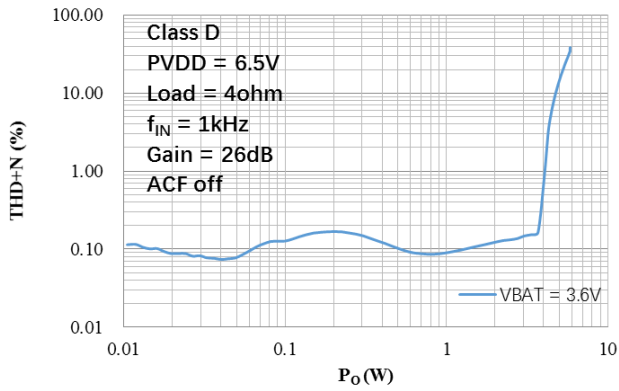
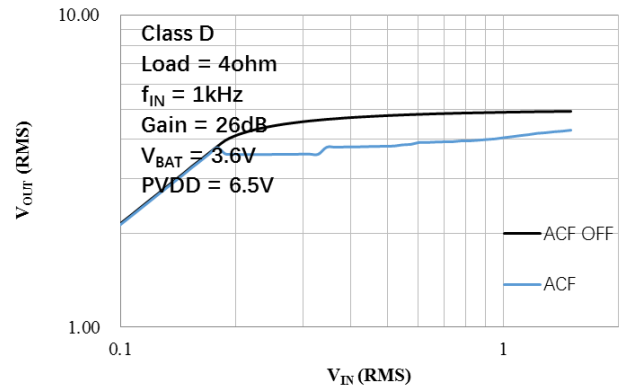
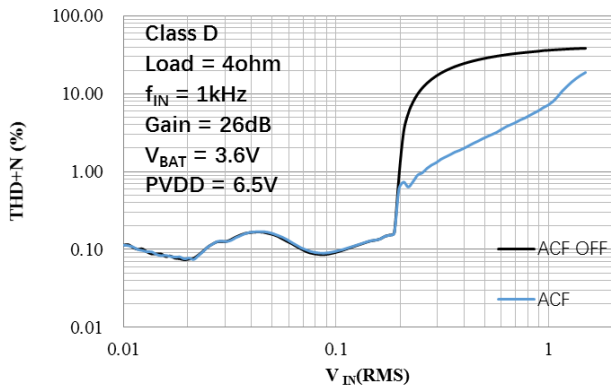
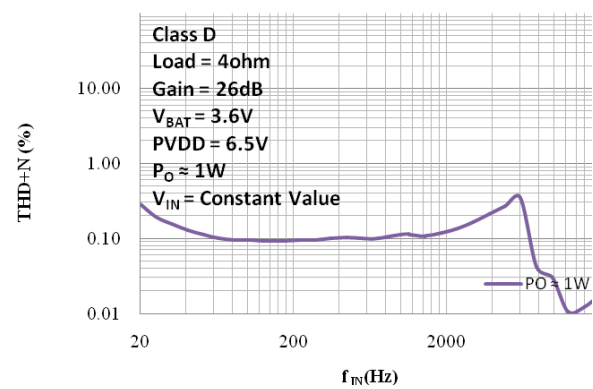
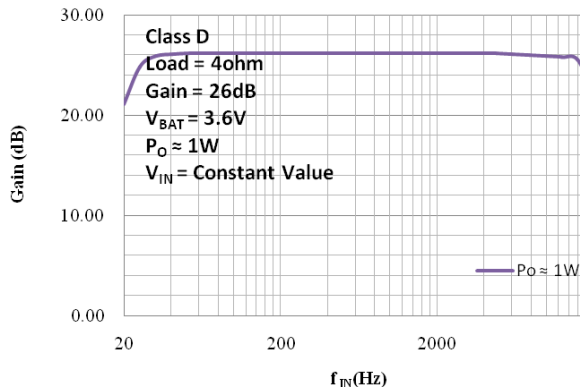
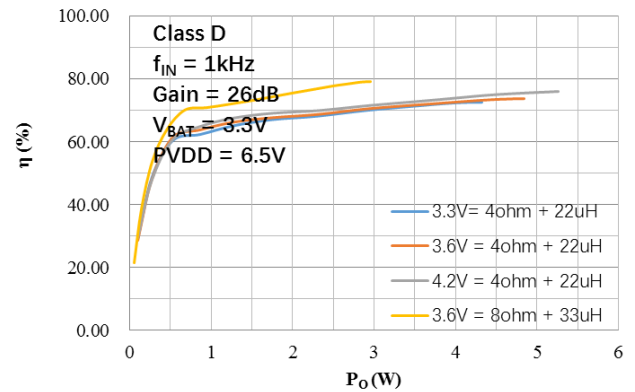
P_O vs THD+N

 V_{IN} vs V_{OUT}

 V_{IN} vs THD+N

 f_{IN} vs THD+N

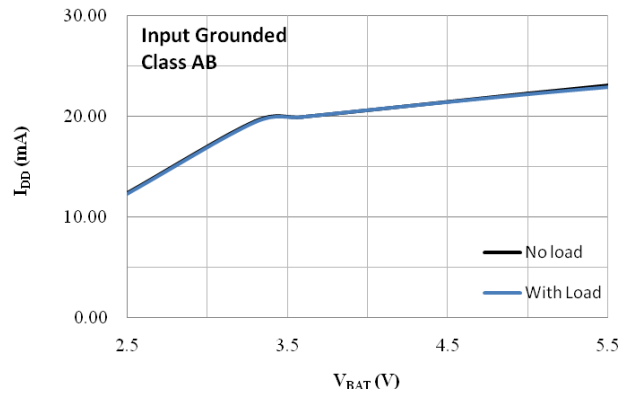
 f_{IN} vs Gain

 P_O vs η

Class AB Channel

Condition: Class AB mode, $V_{BAT} = 3.6V$, $f_{IN} = 1kHz$, $R_{IN} = 56k$, Gain = 20dB, Output = Load = 4ohm, unless otherwise specified

V_{BAT} vs I_{DD}



V_{BAT} vs P_O

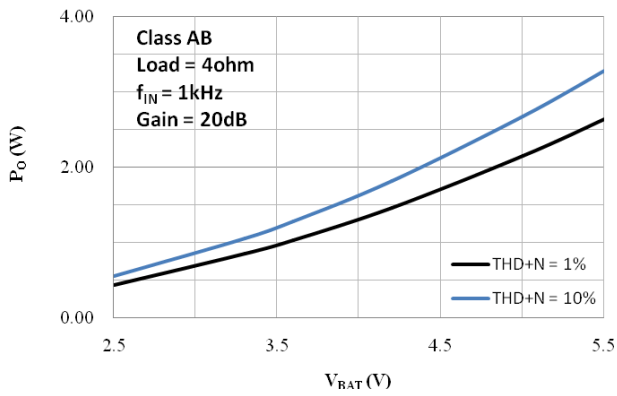

V_{BAT} vs P_O

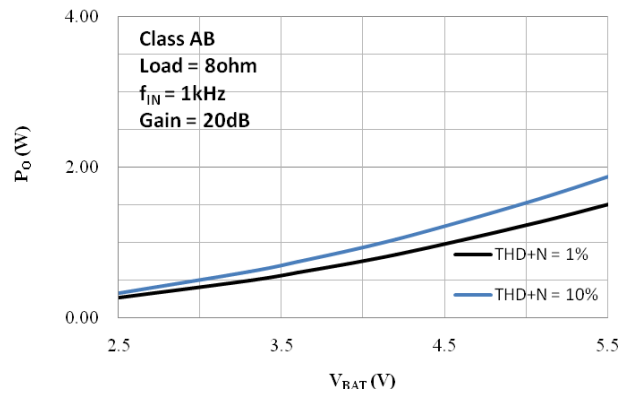

V_{BAT} vs P_{VDD}

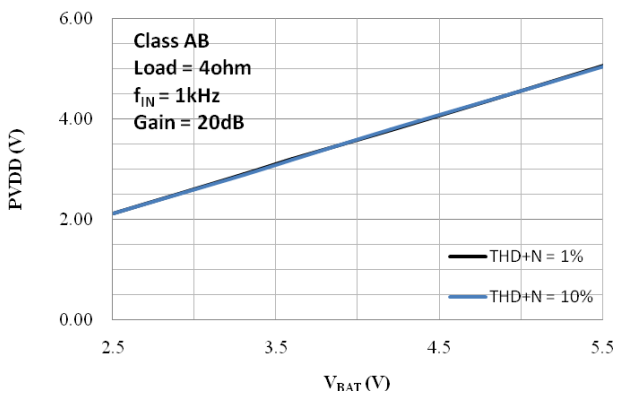

P_O vs THD+N

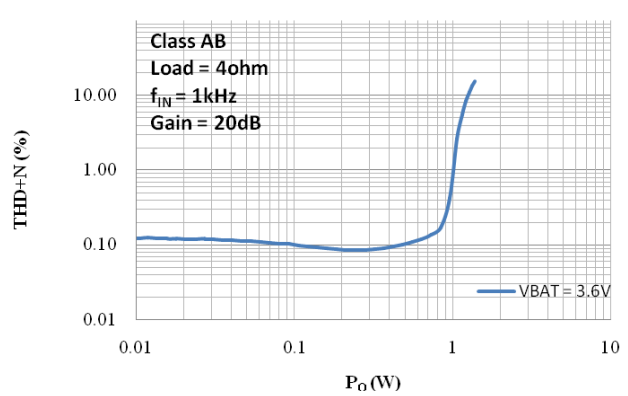

f_{IN} vs Gain

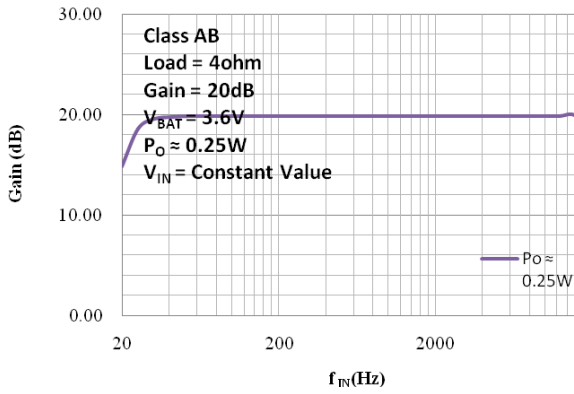

f_{IN} vs THD+N

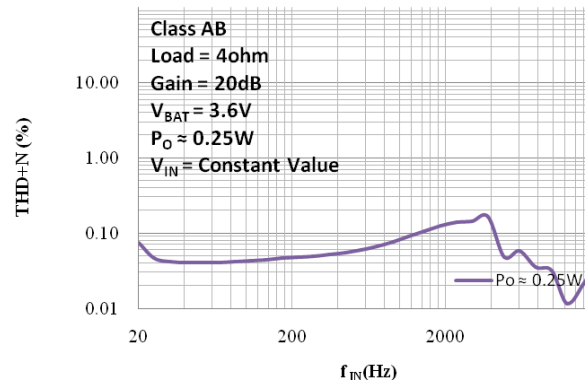

P_O vs η

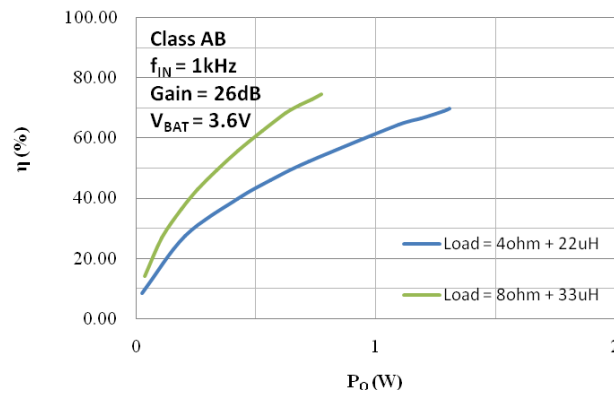

APPLICATION INFORMATION

● BOOST Converter

(1) Setting Output Voltage

The output voltage is set by a resistive voltage divider from the output voltage to FB terminal, which is shown below. The output voltage can be calculated by $PVDD = 1.24 * (Rd1 + Rd2) / Rd2$.

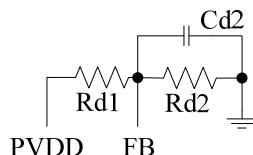

Fig. 1 FB Terminal Configuration

Some typical output voltages can be got by following settings.

Table 1. Output Voltage Setting

PVDD	Rd1	Rd2	Cd2
5.0V	120K	39.5K	3.3nF
6.5V	120K	28K	3.3nF
7.0V	120K	25.5K	3.3nF

(2) LX Terminal

It is strongly recommended to place an RC circuit from the terminal of LX to Ground, shown as following, so that the ripple current of Boost Converter can be decreased. Meanwhile, the total consumption current of the system will be larger so that the efficiency of the system will be lower. Specifications in this file is measured under the condition with RC.

Notes: RC should be placed as closely to LX pin as possible.

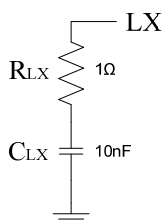

Fig. 2 LX Terminal Configuration

(3) Capacitor Selection

The input and output capacitor (C_{IN} and C_{OUT}) is required to maintain the DC voltage. Low ESR capacitors are preferred to reduce the output voltage ripple. 1uF//10uF//470uF (paralleled) is highly recommended to be placed in both input and output terminal as closely to the pin as possible.

(4) Inductor Selection

Inductance value is decided based on different condition. $L \geq 4.7\mu H$, $DCR < 1\Omega$, $I_{SAT} \geq 2.5A$ is recommended for general application circuit.

(5) Schottky Diode Selection

$V_{RRM} > 12V$, $V_{FM} < 0.5V$, $I_F \geq 1.5A$ is recommended for general application circuit.

(6) Layout Consideration

1. The power traces, consisting of the GND, LX, V_{BAT} and PVDD trace should be kept short, direct, wide, and as closely to the pin as possible. The switching node LX should be paid more attention for EMI and

reliability consideration.

2. Place C_{IN} and C_{OUT} near V_{BAT} and $PVDD$ as closely as possible to maintain voltage steady, and filter out the pulsing current.
3. The resistive divider R should be connected to pin directly as closely as possible. FB is a sensitive node. Please keep it away from switching node, LX .
4. The GND of the IC, C_{IN} and C_{OUT} should be connected close together directly to ground plane.

● **Analog Signal Input Configuration**

HT8691 is an amplifier with analog input (single-ended or differential). For a differential input between $IN+$ and $IN-$ pins, signals input via DC-cut capacitors (C_{IN}). The input signal gain is calculated by $A_v \approx 1200k/R_{IN}$ (Class D mode) or $A_v \approx 600k/R_{IN}$ (Class AB mode). And, the low pass cut-off frequency of input signal, can be calculated by $f_c = 1/(2\pi R_{IN} C_{IN})$.

For a single-ended input at $IN+$ pin, signal input via a DC-cut capacitor (C_{IN}). $IN-$ pin should be connected to ground via a DC-cut capacitor (with the same value of C_{IN}). The Gain and low pass Cut-off frequency are the same as the above case.

The output impedance (Z_{out}) of the former source circuit, including signal paths up to $IN+$ terminal and $IN-$ terminal should be designed to be 600Ω or lower.

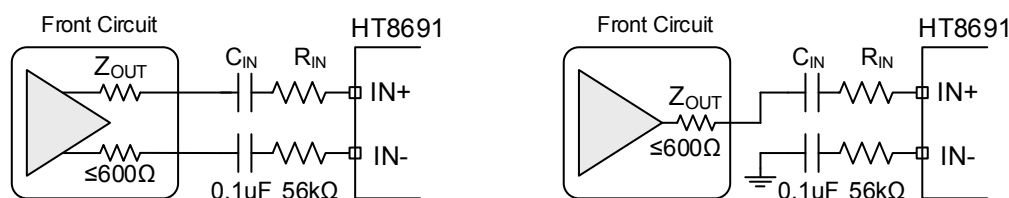

Fig. 3 (1) Differential Input;

(2) Single-ended Input

● **Output Configuration**

As mentioned, HT8691 can directly drive speakers without any other components. But there are exceptions. Once HT8691 works in class D mode, the cable lined to the speaker is very long, and EMI is concerned, ferrite beads or L-C filter is needed.

If the BOOST output voltage is high ($\geq 7V$), the power supply ripple for class D amplifier is high, the voltage level of input signals is high ($\geq 1.0V_{rms}$), or the impedance of the load speaker is low ($\leq 4\Omega$), a bigger value of capacitance ($\geq 470\mu F$) in the terminal of $PVDD$ needs to be added, and a Snubber circuit and two Schottky diodes added in the output terminal can be a choice to protect the chip from damage.

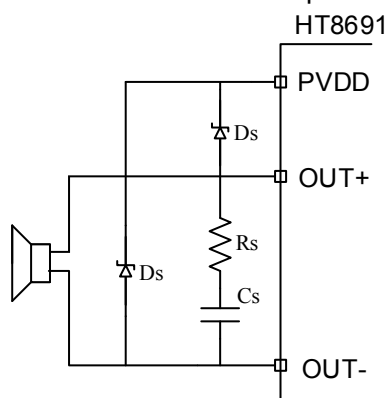

Fig. 4 Snubber Circuit and Schottky Diodes for Output Terminal

Recommended component parameters:

R_s : 1.5 ~ 2 Ω ;

C_s : 330pF~680pF;

D_s : Maximum Average Forward Rectified Current $I_{AV} \geq 3A$; Maximum Instantaneous Forward Voltage $\leq 0.5V$; Peak Forward Surge Current $I_{FSM} \geq 6A$.

● **CTRL Terminal Mode Control**

HT8691 can work in different modes by setting the CTRL terminal, shown as follow.

Table. 2 CTRL Terminal Mode Control

MODE	SYMBOL	CTRL Voltage			
		MIN.	TYP.	MAX.	UNIT
Class D mode in ACF-Off with Boost Converter	V_{MOD1}	0.75PVDD		PVDD	V
Class D mode in ACF-ON with Boost Converter	V_{MOD2}	0.50PVDD		0.60PVDD	V
Class AB mode in ACF-Off without Boost Converter	V_{MOD3}	0.15PVDD		0.35PVDD	V
SD(Shutdown) Mode	V_{MOD4}	VSS		0.06PVDD	V

Notes: ACF-ON mode can only be worked in class D mode. A 120kΩ pull-down resistor are inside of the CTRL terminal, shown as follows, but the pull-down resistor will be gone in Class AB mode. An outside pull down resistor is still needed for stability.



Fig. 5 CTRL Terminal

● **Anti-Clipping Function (ACF) and mode Configuration**

(1) **ACF ON Mode**

In ACF-ON modes, HT8691 attenuates system gain to an appropriate value when an excessive input is applied, so as not to cause the clipping at the differential signal output. In this way, the output audio signal is controlled in order to obtain a maximum output level without distortion. And HT8691 also follows to the clips of the output waveform due to the decrease in the power-supply voltage.

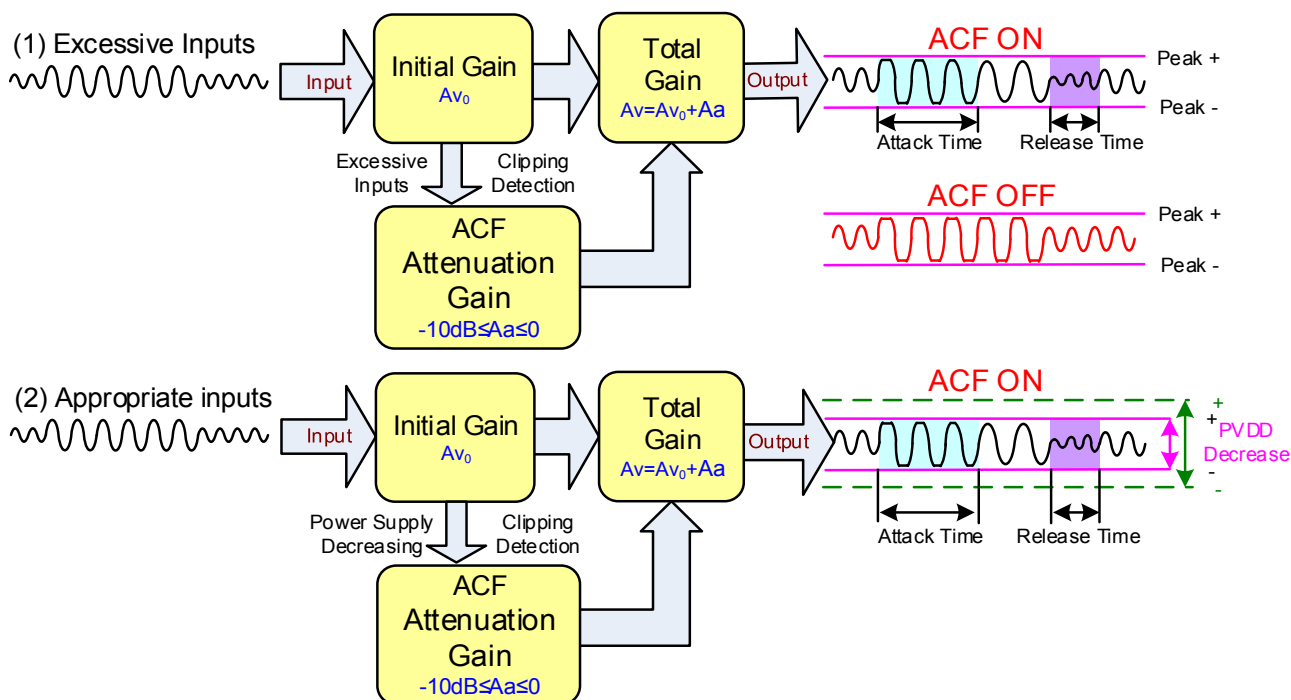

Fig. 6 the ACF Function Operation Outline

The Attack time of ACF Function is a time interval until system gain falls to target attenuation gain -3dB when a big enough signal inputs. And, the Release Time is a time from target attenuation gain to not working of ACF. The maximum attenuation gain is 16dB.

Table 3 Attack time and Release time

ACF mode	Attack time	Release time
ACF-1	50ms	64ms

(2) ACF OFF Mode

In ACF-Off mode, ACF function is disabled. HT8691 will not detect output clipping and the system gain is kept to be $A_v=A_{v0}$. The audio quality would worsen due to clipping distortion.

(3) Class AB mode

In Class AB mode, ACF function is also disabled. HT8691 works as Class AB audio Amplifier, the boost converter is disabled as well.

(4) SD Mode

In shutdown mode, HT8691 shuts all circuit down and minimizes the power consumption. And, the output terminals become Weak Low (A high resistance grounded state).

● Pop-Click Noise Reduction

The Pop-Click Noise Reduction Function of HT8691 works in the cases of Power-on, Power-off, Shutdown on, and Shutdown off. To achieve a more excellent noise reduction performance, it is recommended to use a DC-cut capacitor (C_{IN}) of 0.1 μ F or less.

Besides, POP noise can be minimal according to the following procedure of shutdown control.

- During power-on, Shutdown mode is not cancelled until the power supply is stabilized enough.
- Before Power-off, set Shutdown mode first.

The pop-click noise: Power-on/off > Shutdown on/off.

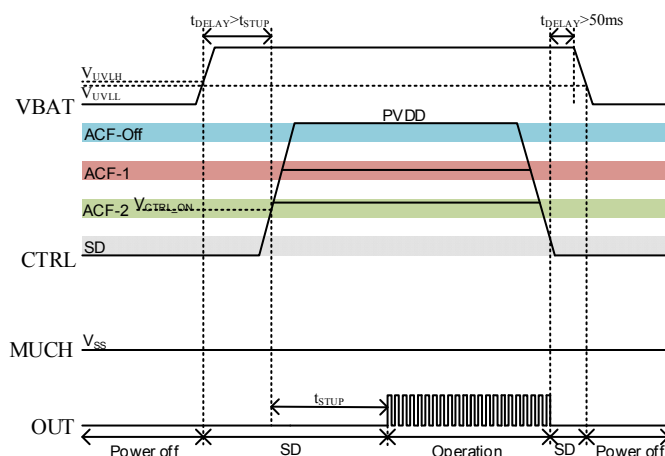

Fig. 7 Pop-Click Noise Reduction by Shutdown

● Protection Function

HT8691 has the protection functions such as Over-Current Protection function, Thermal Protection function, and Low Voltage Malfunction Prevention function.

(1) Over-current Protection function

When a short circuit occurs between one output terminal and Ground, PVDD, or the other output, the over-current protection mode starts up. In the over current protection mode, the differential output terminal becomes a high impedance state. Once the short circuit conditions is eliminated, the over current protection mode can be cancelled automatically.

(2) Thermal Protection function

When excessive high temperature of HT8691 (150°C) is detected, the thermal protection mode starts up. In the

thermal protection mode, the differential output terminal becomes Weak Low state (a state grounded through high impedance).

(3) Low voltage Malfunction Prevention function

This is the function to establish the low voltage protection mode when PVDD terminal voltage becomes lower than the detection voltage (V_{UVLL}) for the low voltage malfunction prevention. And the protection mode is canceled when PVDD terminal voltage becomes higher than the threshold voltage (V_{UVLH}). In the low voltage protection mode, the differential output pin becomes Weak Low state (a state grounded through high impedance). HT8691 will start up within the start-up time (T_{STUP}) when the low voltage protection mode is cancelled

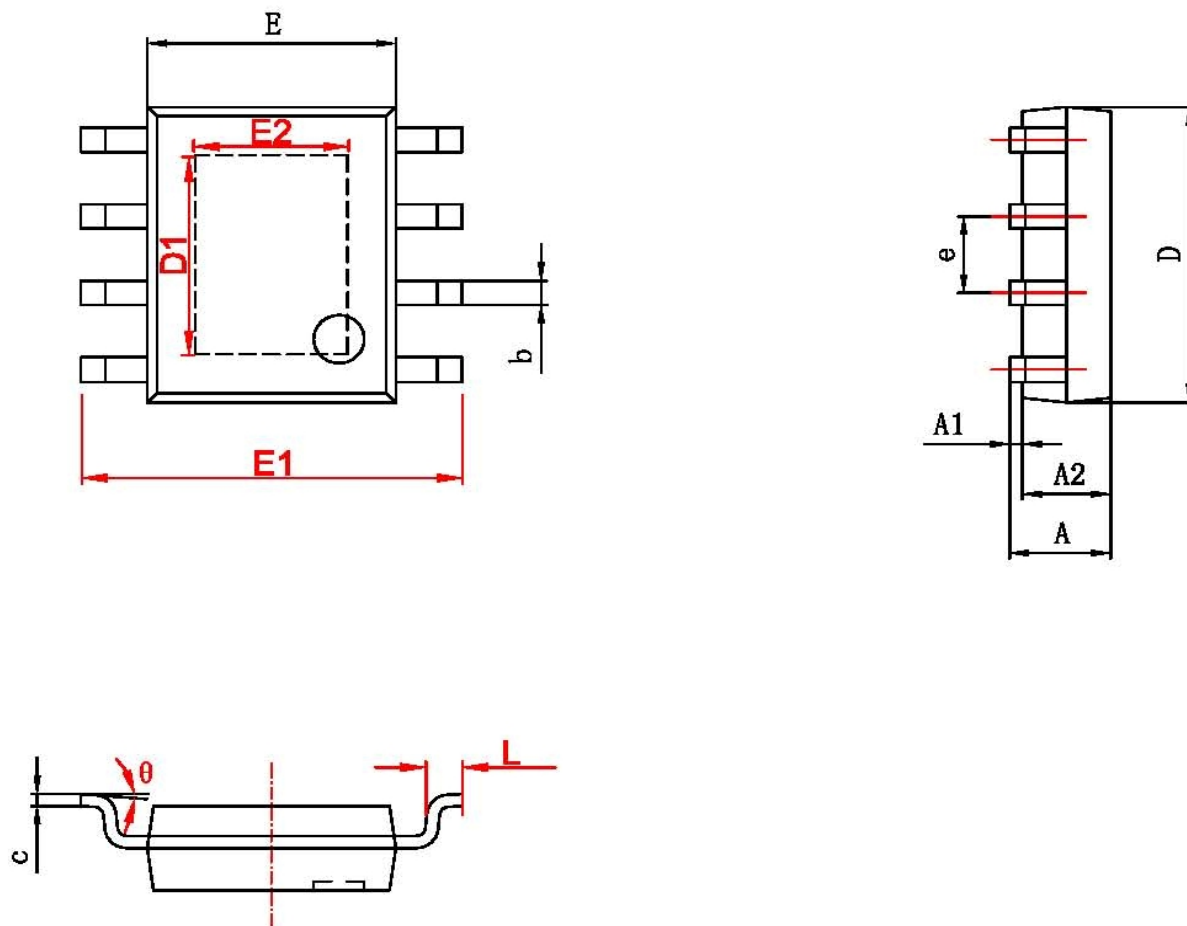
PACKAGE OUTLINE
SOP8-PP(EXP PAD) PACKAGE OUTLINE DIMENSIONS

字符	Dimensions In Millimeters		Dimensions In Inches	
	Min	Max	Min	Max
A	1.350	1.750	0.053	0.069
A1	0.050	0.150	0.002	0.006
A2	1.350	1.550	0.053	0.061
b	0.330	0.510	0.013	0.020
c	0.170	0.250	0.007	0.010
D	4.700	5.100	0.185	0.200
D1	3.202	3.402	0.126	0.134
E	3.800	4.000	0.150	0.157
E1	5.800	6.200	0.228	0.244
E2	2.313	2.513	0.091	0.099
e	1.270 (BSC)		0.050 (BSC)	
L	0.400	1.270	0.016	0.050
θ	0°	8°	0°	8°

X-ON Electronics

Largest Supplier of Electrical and Electronic Components

Click to view similar products for [Audio Amplifiers](#) category:

Click to view products by [Jiaxing Glead](#) manufacturer:

Other Similar products are found below :

[LV47002P-E](#) [NCP2890AFCT2G](#) [NTE1192](#) [LC706200CM](#) [IS31AP4915A-QFLS2-TR](#) [TDA1591T](#) [TS2012EIJT](#) [NCP2809BMUTXG](#)
[NJW1157BFC2](#) [IS31AP4996-GRLS2-TR](#) [NCP2823BFCT1G](#) [BD88420GUL-E2](#) [LA4450L-E](#) [IS31AP2036A-CLS2-TR](#) [NTE1110](#) [NTE7100](#)
[NTE7114](#) [NTE7163](#) [NTE7168](#) [NTE7177](#) [NTE7178](#) [NTE7186](#) [NTE7198](#) [NTE7202](#) [NTE7217](#) [BD88400GUL-E2](#) [BD88200GUL-E2](#)
[SABRE9601K](#) [THAT1646W16-U](#) [PAM8965ZLA40-13](#) [TSDP10XX1NLGXZBX](#) [TSDP11XX1NKGIZBX](#) [TSDP11XX1NLGXZBX](#)
[TSDP10XX1NKGIZBX](#) [NJM4580CV-TE1](#) [NJU7084R-TE1](#) [OPA1655DR](#) [LV4910T-MPB-E](#) [NCP2890AFCT2](#) [NCV2211DR2G](#)
[SCY99091FCT2G](#) [TAS5720MRSMR](#) [AW87389FCR](#) [AW8737AFCR](#) [TDA2005R](#) [TDA2030](#) [TDA7265L-J11-A-T](#) [CD2050CZ](#)
[AW88261FCR](#) [TDA7377-JSM](#)