



Description

JMT P-channel MOSFET

Features

- $V_{DS}=-20V$, $I_D=-55A$
 $R_{DS(ON)} < 8.5m\Omega$ @ $V_{GS} = -4.5V$
 $R_{DS(ON)} < 12m\Omega$ @ $V_{GS} = -2.5V$
- High Power and Current Handling Capability
- Lead Free Product is Acquired
- Surface Mount Package

Application

- PWM Applications
- Load Switch



100% UIS TESTED!
100% ΔVds TESTED!

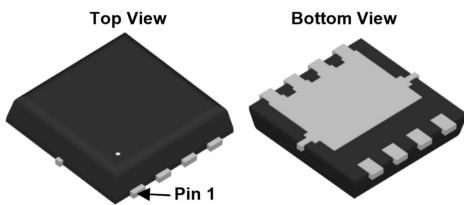

PDFN3.3X3.3-8L

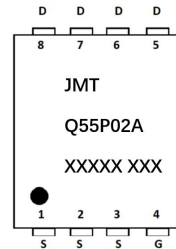

Marking and pin Assignment

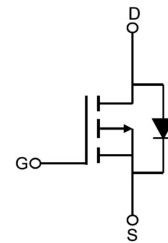

Schematic Diagram

Package Marking and Ordering Information

Device Marking	Device	OUTLINE	Device Package	Reel Size	Reel (PCS)	Per Carton (PCS)
JMTQ55P02A	JMTQ55P02A	TAPING	PDFN3.3X3.3-8L	13inch	5000	50,000

Absolute Maximum Ratings ($T_C=25^\circ C$ unless otherwise specified)

Symbol	Parameter	Max.	Units
V_{DSS}	Drain-Source Voltage	-20	V
V_{GSS}	Gate-Source Voltage	± 12	V
I_D	Continuous Drain Current	$T_C = 25^\circ C$	-55
		$T_C = 100^\circ C$	-35
I_{DM}	Pulsed Drain Current ^{note1}	-220	A
P_D	Power Dissipation	38	W
$R_{\theta JC}$	Thermal Resistance, Junction to Ambient	3.2	$^\circ C/W$
T_J, T_{STG}	Operating and Storage Temperature Range	-55 to +150	$^\circ C$



Electrical Characteristics (T_J=25°C unless otherwise specified)

Symbol	Parameter	Test Condition	Min.	Typ.	Max.	Units
Off Characteristic						
V _{(BR)DSS}	Drain-Source Breakdown Voltage	V _{GS} =0V, I _D = -250μA	-20	-	-	V
I _{DSS}	Zero Gate Voltage Drain Current	V _{DS} = -20V, V _{GS} = 0V,	-	-	-1	μA
I _{GSS}	Gate to Body Leakage Current	V _{DS} =0V, V _{GS} = ±12V	-	-	±100	nA
On Characteristics						
V _{GS(th)}	Gate Threshold Voltage	V _{DS} = V _{GS} , I _D = -250μA	-0.35	-0.65	-1.0	V
R _{DS(on)}	Static Drain-Source on-Resistance <small>note3</small>	V _{GS} =-4.5V, I _D =-15A	-	6.6	8.5	mΩ
		V _{GS} =-2.5V, I _D =-12A	-	8	12	
Dynamic Characteristics						
C _{iss}	Input Capacitance	V _{DS} =-10V, V _{GS} =0V, f = 1.0MHz	-	4600	-	pF
C _{oss}	Output Capacitance		-	460	-	pF
C _{rss}	Reverse Transfer Capacitance		-	459	-	pF
Q _g	Total Gate Charge	V _{DS} =-10V, I _D =-15A, V _{GS} =-4.5V	-	46	-	nC
Q _{gs}	Gate-Source Charge		-	7.3	-	nC
Q _{gd}	Gate-Drain("Miller") Charge		-	10	-	nC
Switching Characteristics						
t _{d(on)}	Turn-on Delay Time	V _{DD} =-10V, I _D =-14A, R _{GEN} =2.7Ω, V _{GS} =-10V	-	8	-	ns
t _r	Turn-on Rise Time		-	59	-	ns
t _{d(off)}	Turn-off Delay Time		-	111	-	ns
t _f	Turn-off Fall Time		-	43	-	ns
Drain-Source Diode Characteristics and Maximum Ratings						
I _S	Maximum Continuous Drain to Source Diode Forward Current		-	-	-55	A
I _{SM}	Maximum Pulsed Drain to Source Diode Forward Current		-	-	-220	A
V _{SD}	Drain to Source Diode Forward Voltage	V _{GS} = 0V, I _S =-20A	-	-	-1.2	V
trr	Reverse Recovery Time	T _J =25°C, I _{SD} =-15A,	-	18	-	ns
Qrr	Reverse Recovery Charge	V _{GS} =0V di/dt=-100A/μs	-	7.7	-	Nc

- Notes:1. Repetitive Rating: Pulse Width Limited by Maximum Junction Temperature
2. EAS condition: T_J=25°C, V_{DD}=-10V, V_G=-10V, R_G=5.9Ω, L=0.5mh, I_{AS}=-13.2A
3. Pulse Test: Pulse Width≤300μs, Duty Cycle≤0.5%



Typical Performance Characteristics

Figure 1: Output Characteristics

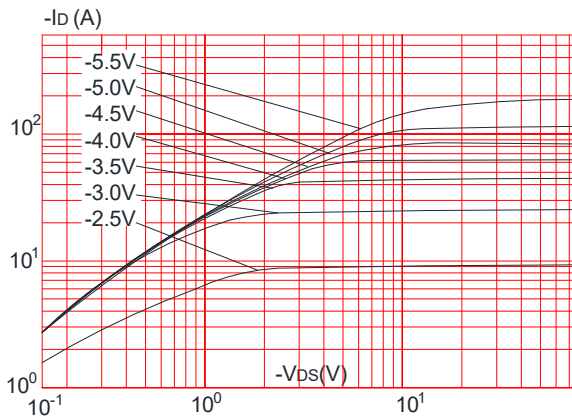

Figure 2: Typical Transfer Characteristics

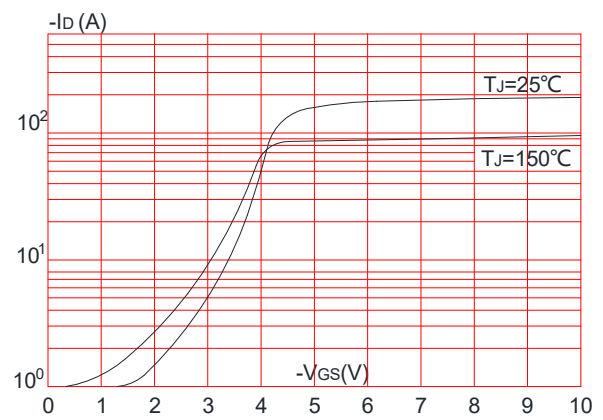

Figure 3: On-resistance vs. Drain Current

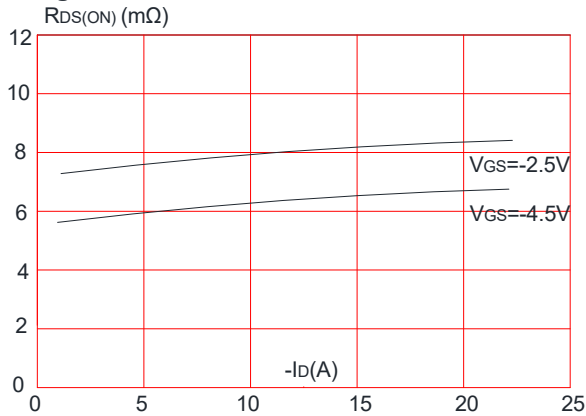

Figure 4: Body Diode Characteristics

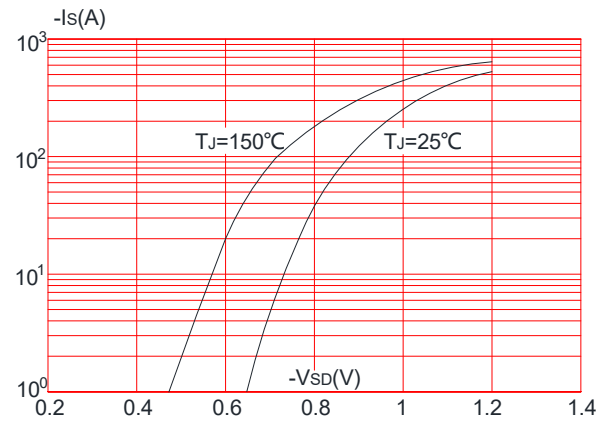

Figure 5: Gate Charge Characteristics

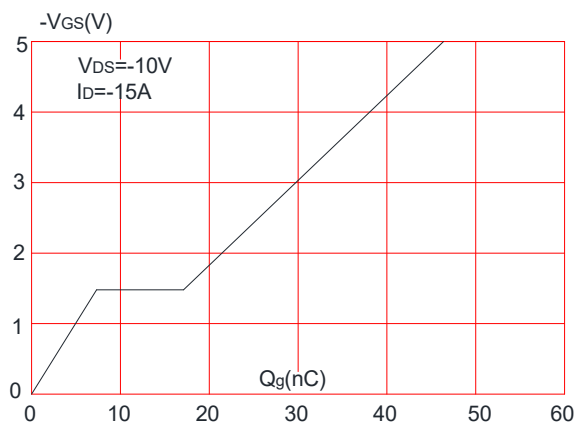

Figure 6: Capacitance Characteristics

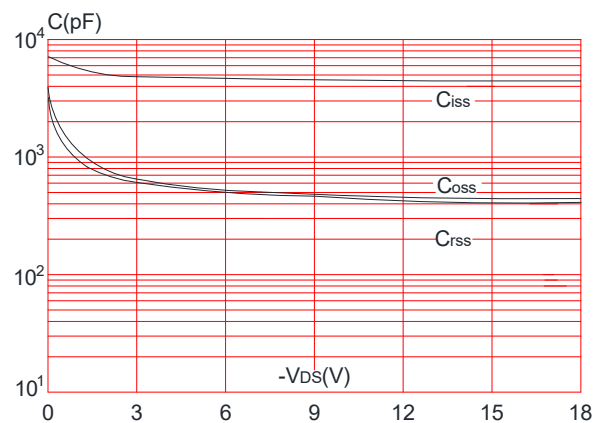



Figure 7: Normalized Breakdown Voltage vs. Junction Temperature

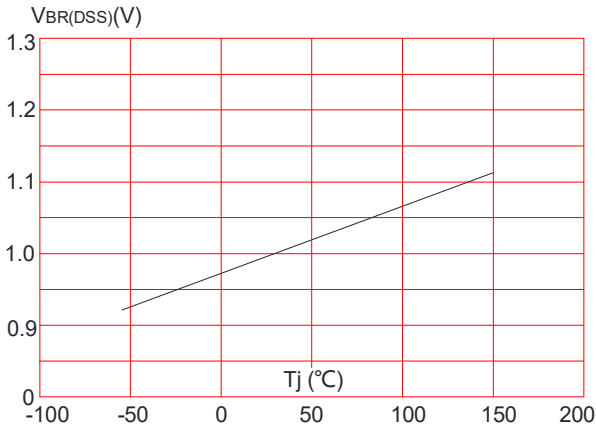

Figure 8: Normalized on Resistance vs. Junction Temperature

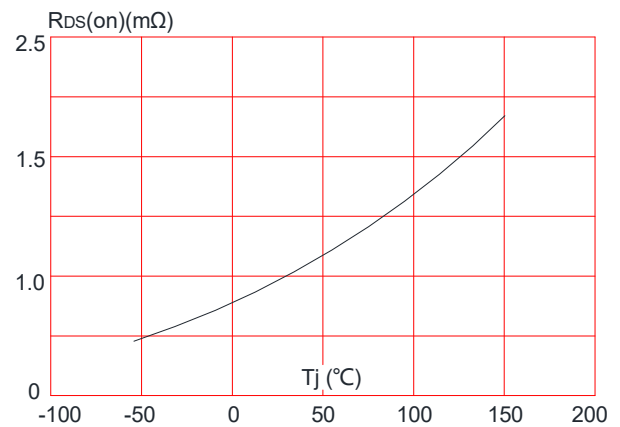

Figure 9: Maximum Safe Operating Area

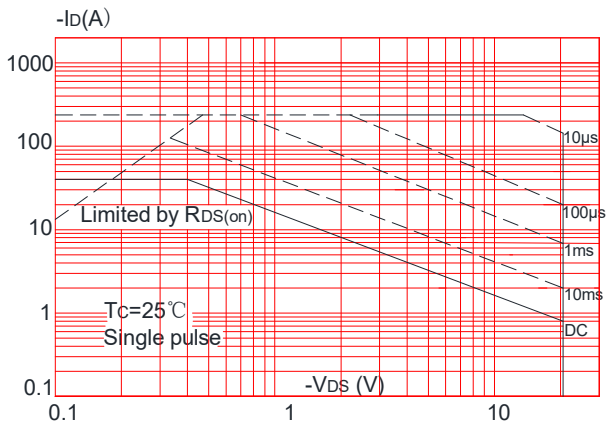

Figure 10: Maximum Continuous Drain Current vs. Case Temperature

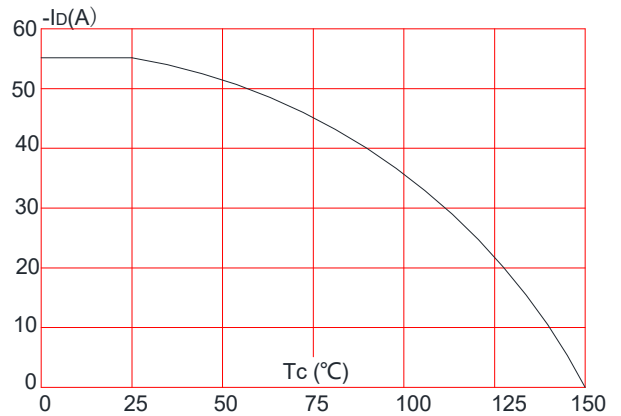
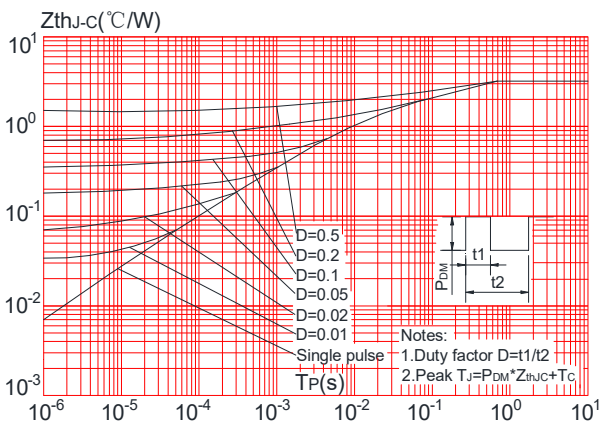
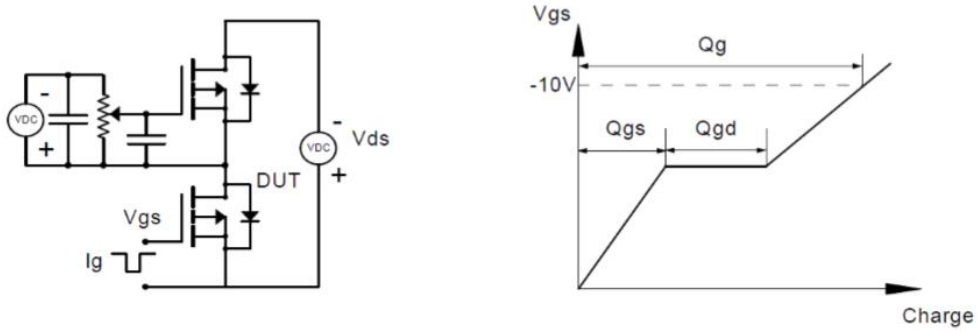

Figure.11: Maximum Effective Transient Thermal Impedance, Junction-to-Case



Test Circuit

Gate Charge Test Circuit & Waveform



Resistive Switching Test Circuit & Waveforms

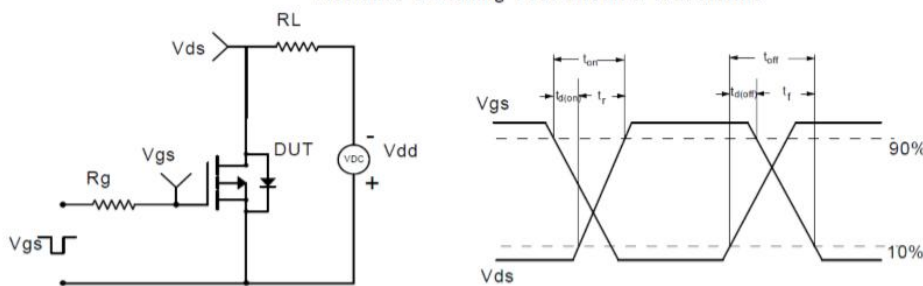

Unclamped Inductive Switching (UIS) Test Circuit & Waveforms

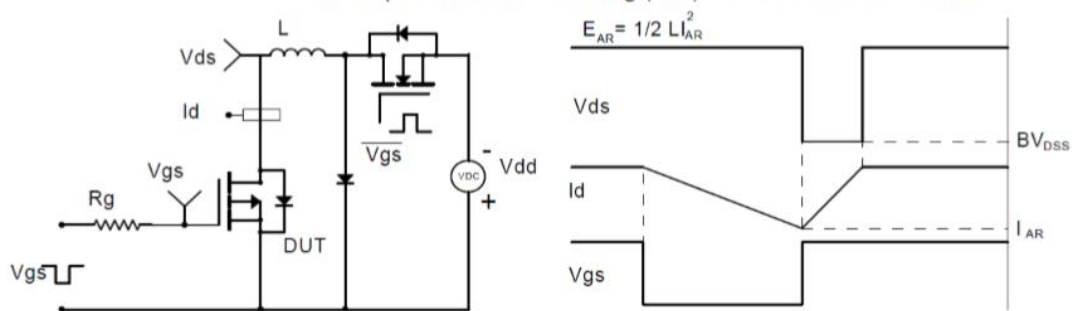

Diode Recovery Test Circuit & Waveforms

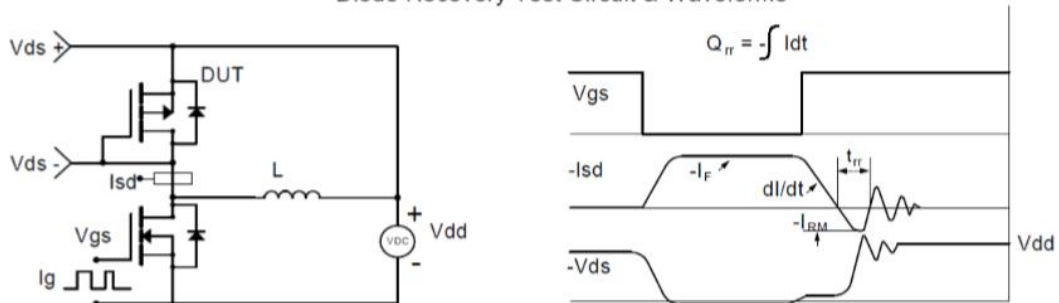



Package Mechanical Data

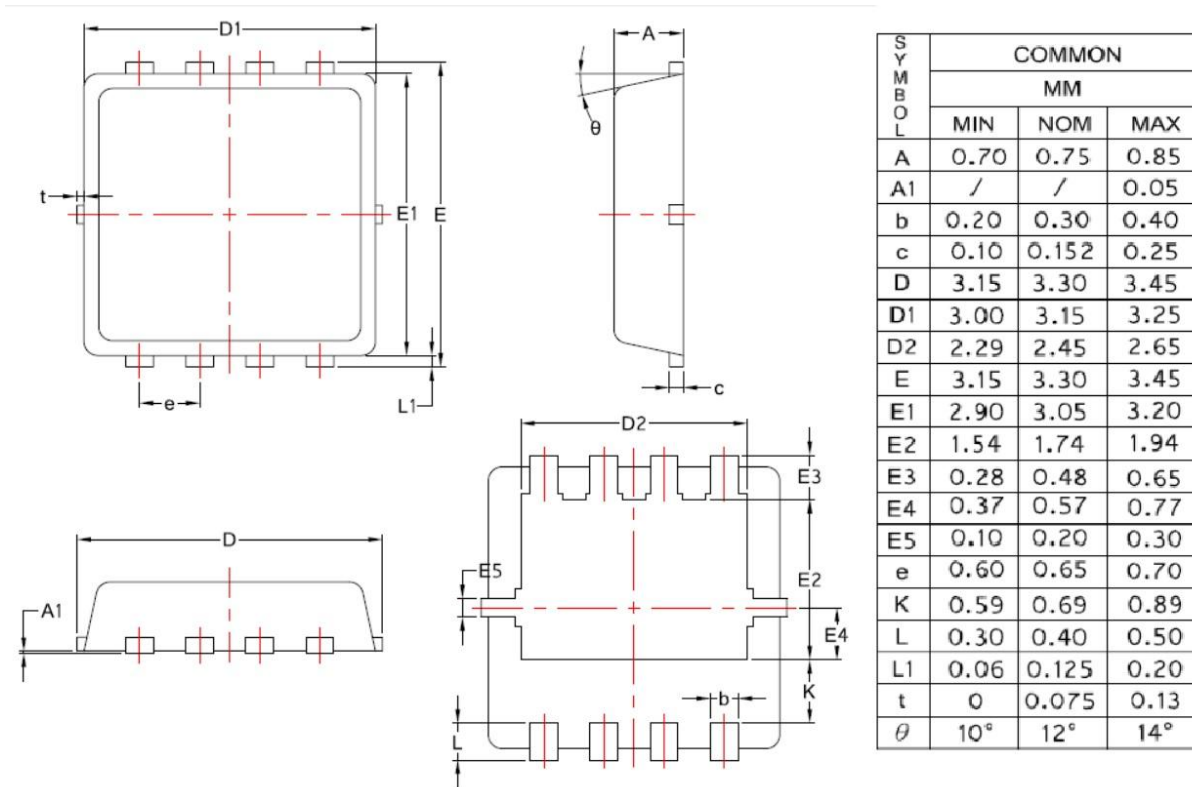

Information furnished in this document is believed to be accurate and reliable. However, Jiangsu JieJie Microelectronics Co.,Ltd assumes no responsibility for the consequences of use without consideration for such information nor use beyond it.

Information mentioned in this document is subject to change without notice, apart from that when an agreement is signed, Jiangsu JieJie complies with the agreement.

Products and information provided in this document have no infringement of patents. Jiangsu JieJie assumes no responsibility for any infringement of other rights of third parties which may result from the use of such products and information.



is a registered trademark of Jiangsu JieJie Microelectronics Co.,Ltd.

Copyright ©2019 Jiangsu JieJie Microelectronics Co.,Ltd. Printed All rights reserved.

X-ON Electronics

Largest Supplier of Electrical and Electronic Components

Click to view similar products for [MOSFET](#) category:

Click to view products by [JieJie](#) manufacturer:

Other Similar products are found below :

[IRFD120](#) [JANTX2N5237](#) [2SK2267\(Q\)](#) [BUK455-60A/B](#) [TK100A10N1,S4X\(S](#) [MIC4420CM-TR](#) [VN1206L](#) [NDP4060](#) [SI4482DY](#)
[IRS2092STRPBF-EL](#) [IPS70R2K0CEAKMA1](#) [SQM120N06-3M5L-GE3](#) [TK31J60W5,S1VQ\(O](#) [TK31J60W,S1VQ\(O](#) [TK16J60W,S1VQ\(O](#)
[2SK2614\(TE16L1,Q\)](#) [DMN1017UCP3-7](#) [EFC2J004NUZTDG](#) [P85W28HP2F-7071](#) [NTE2384](#) [DMC2700UDMQ-7](#) [DMN2080UCB4-7](#)
[DMN61D9UWQ-13](#) [US6M2GTR](#) [DMN31D5UDJ-7](#) [DMP22D4UFO-7B](#) [IPS60R3K4CEAKMA1](#) [DMN1006UCA6-7](#) [DMN16M9UCA6-7](#)
[STF5N65M6](#) [IRF40H233XTMA1](#) [STU5N65M6](#) [DMN6022SSD-13](#) [DMN13M9UCA6-7](#) [DMTH10H4M6SPS-13](#) [IPS60R360PFD7SAKMA1](#)
[DMN2990UFB-7B](#) [SSM3K35CT,L3F](#) [IPLK60R1K0PFD7ATMA1](#) [2N7002W-G](#) [MCAC30N06Y-TP](#) [IPWS65R035CFD7AXKSA1](#)
[MCQ7328-TP](#) [SSM3J143TU,LXHF](#) [DMN12M3UCA6-7](#) [PJMF280N65E1_T0_00201](#) [PJMF380N65E1_T0_00201](#)
[PJMF280N60E1_T0_00201](#) [PJMF600N65E1_T0_00201](#) [PJMF900N65E1_T0_00201](#)