

NOTES1:

- UL Standard
- 1. Rated voltage/current : 300V / 8A
- 2. Withstanding voltage : AC1600V/1Min.
- 3. Wire range : 24~16AWG

IEC Standard

1. Pollution degree	2	2	3
Overvoltage category	II	III	III
Rate impulse voltage(KV)	2.5KV	2.5KV	2.5KV
Rate voltage(V)	320V	160V	160V
Rate current(A)	8A		

- 2. Wire range : 0.2~1.0mm², 1.5mm²(sol)

NOTES2:

- 1. Dimension shall be interpreted per ASME Y14.5-2009
- 2. Pitch : 3.50mm, Poles : N=04~48P
- 3. Stripping length : 8~9mm
- 4. Operating temperature: -40°C~+105°C
- 5. Undimensioned tolerances:

Pitch range in mm	Nominal dimension		range		Tolerance
	Over	In	Over	Over	
6	10	TO	30	60	0.1/10
10	10	TO	100	100	≤
24	30	TO	100	150	
6	10	TO	60	100	±2°
10	24	TO	60	150	

6. RoHS Compliance

Ordering Information

JL15EDGKNHCM-350 XX G 0 1

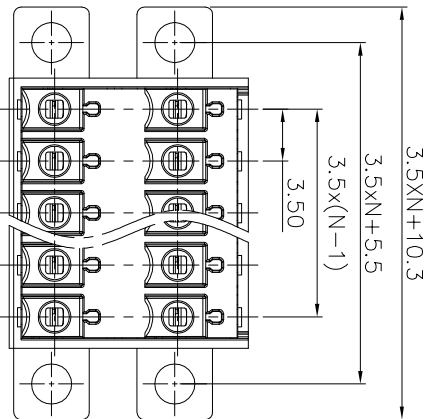
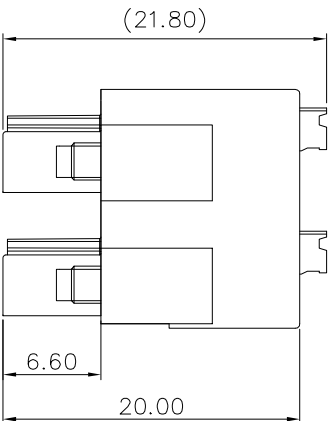
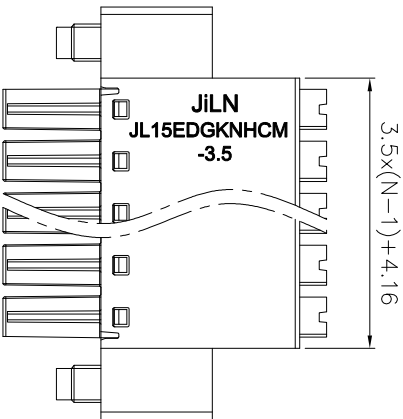
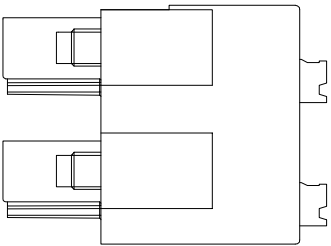
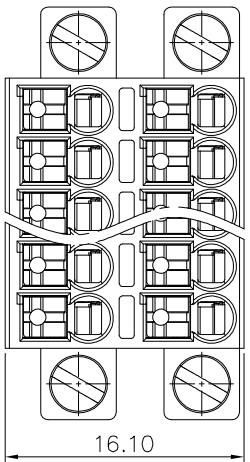
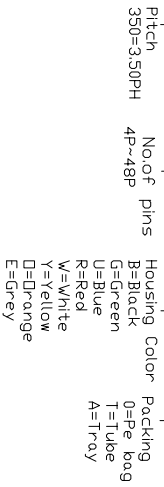

DRAW	SHUANGPING ZHENG		SCALE	FIT	 东莞市锦凌电子有限公司 DONGGUAN JINLING ELECTRONIC CO., LTD	
CHECK	LICHAD LIU	UNIT	mm			
APPROVE	YONGLIANG GAO	SIZE	A4	PART NO.	JL15EDGKNHCM-350XXG01	
		SHEET	1/1	TITLE:	JL15EDGKNHCM-3.5-2XNP 插拔式母座绿色	
		PRD				

REVISION RECORD				
REV	ECN	DESCRIPTION	DRFT	DATE
A0		NEW		21.06.08

X-ON Electronics

Largest Supplier of Electrical and Electronic Components

Click to view similar products for [Pluggable Terminal Blocks](#) category:

Click to view products by [JILN](#) manufacturer:

Other Similar products are found below :

[57.510.0053](#) [721-104/026-047](#) [721-204/026-045](#) [MC 1.5/ 6-ST-3.5 GY AU](#) [ET02015000J0G](#) [860505](#) [860516](#) [860810](#) [GBPACX-12](#)
[93.731.4953.0](#) [PVP03-3,50](#) [PVS02-5,00](#) [1-1986160-3](#) [1377680000](#) [1531000000](#) [1546228-5](#) [ELFP03110](#) [ELFP10210](#) [ELFT07250](#)
[ELVD12100](#) [ELVF09400](#) [ELXH071G0E](#) [1725220000](#) [1760336](#) [1855000000](#) [19346](#) [1946309](#) [1973592](#) [19892](#) [25.320.4053.1](#) [25.320.4553.9](#)
[25.320.4753.1](#) [25.320.5453.1](#) [25.340.0353.1](#) [25.340.1053.1](#) [25.345.3553.0M001](#) [25.640.3553.1](#) [SH02-5,08](#) [SH06-3,81](#) [SH08-5,08](#) [SH08-](#)
[5,08-K](#) [SH12-5,08](#) [SHS04-5,00](#) [30.303](#) [30.305](#) [30.306](#) [PHP09-5,08](#) [25.193.0453.0](#) [25.320.4653.1](#) [25.332.2453.1](#)