

NOTES1:

- UL Standard
- 1. Rated voltage/current : 300V / 15A
- 2. Withstanding voltage : AC1600V/1Min.

IEC Standard

|                          |      |      |      |
|--------------------------|------|------|------|
| 1. Pollution degree      | 2    | 2    | 3    |
| Overvoltage category     | II   | III  | III  |
| Rate impulse voltage(KV) | 4KV  | 4KV  | 4KV  |
| Rate voltage(V)          | 630V | 320V | 320V |
| Rate current(A)          | 20A  |      |      |

NOTES2:

- 1. Dimension shall be interpreted per ASME Y14.5-2009
- 2. Pitch : 5.08mm, Poles : N=02~24P
- 3. Operating temperature: -40°C~+105°C
- 4. Undimensioned tolerances:

| Pitch range in mm |       | Nominal dimension range in mm |       | Tolerance |       |
|-------------------|-------|-------------------------------|-------|-----------|-------|
| Over              | TO    | Over                          | TO    | Over      | TO    |
| 6                 | 10    | 30                            | 60    | 0.1/10    |       |
| 10                | 24    | 30                            | 100   |           | <     |
| 10                | 30    | 60                            | 150   |           |       |
| ±0.15             | ±0.20 | ±0.30                         | ±0.50 | ±0.70     | ±1.00 |
|                   |       |                               |       | ±1.30     | ±2    |

5. RoHS Compliance

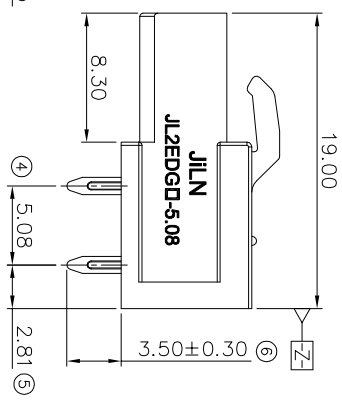
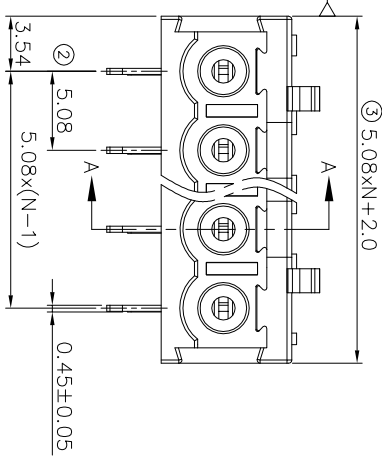
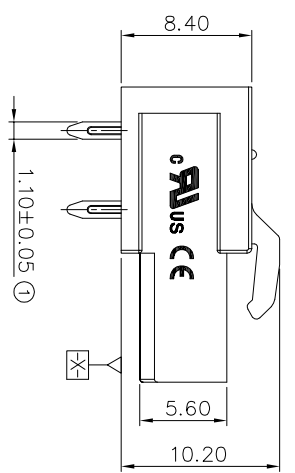
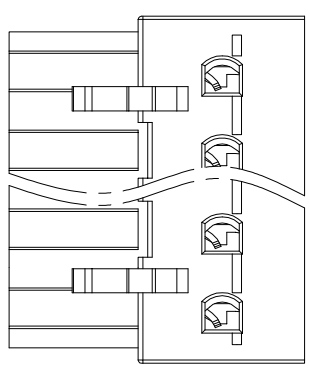

# Ordering Information

**JL2EDGA - 508 XX G 0 1**

- Pitch 508=5.08PH
- No. of pins 2P, 3P, 4P~12P
- Housing Color: B=Black, G=Green, U=Blue, R=Red, W=White, Y=Yellow, D=Drange, E=Grey
- Packing: 0=Pe bag, T=Tube, A=Tray

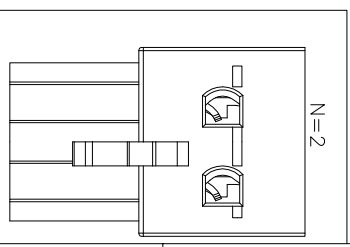
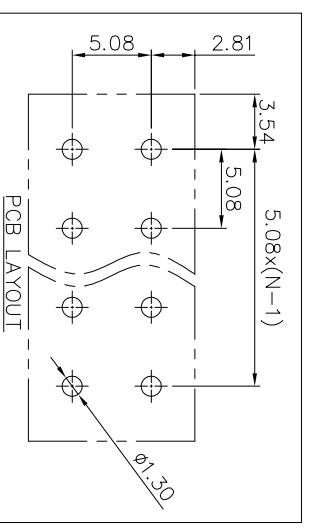

|  |                  |               |       |     |          |                            |
|--|------------------|---------------|-------|-----|----------|----------------------------|
| DRAW   | SHUANGPING ZHENG |               | SCALE | FIT | PART NO. | JL2EDGA-508XXG01           |
|  | UNIT             | mm            |       |     |          |                            |
| CHECK  | LICHAD LIU       |               | SIZE  | A4  | TITLE:   | JL2EDGA-5.08-XXP插拔式母座/弯脚绿色 |
|  | APPROVE          | YONGLIANG GAO |       |     |          |                            |
|  <b>东莞市锦凌电子有限公司</b><br>DONGGUAN JINLING ELECTRONIC CO., LTD |                  |               | PRD   | 1/1 |          |                            |

| REVISION RECORD |     |             |          |
|-----------------|-----|-------------|----------|
| REV             | ECN | DESCRIPTION | DATE     |
| A0              |     | NEW         | 21.06.10 |

## X-ON Electronics

Largest Supplier of Electrical and Electronic Components

*Click to view similar products for [Pluggable Terminal Blocks](#) category:*

*Click to view products by [JILN](#) manufacturer:*

Other Similar products are found below :

[57.510.0053](#) [721-104/026-047](#) [721-204/026-045](#) [MC 1.5/ 6-ST-3.5 GY AU](#) [ET02015000J0G](#) [860505](#) [860516](#) [860810](#) [GBPACX-12](#)  
[93.731.4953.0](#) [PVP03-3,50](#) [PVS02-5,00](#) [1-1986160-3](#) [1377680000](#) [1531000000](#) [1546228-5](#) [ELFP03110](#) [ELFP10210](#) [ELFT07250](#)  
[ELVD12100](#) [ELVF09400](#) [ELXH071G0E](#) [1725220000](#) [1760336](#) [1855000000](#) [19346](#) [1946309](#) [1973592](#) [19892](#) [25.320.4053.1](#) [25.320.4553.9](#)  
[25.320.4753.1](#) [25.320.5453.1](#) [25.340.0353.1](#) [25.340.1053.1](#) [25.345.3553.0M001](#) [25.640.3553.1](#) [SH02-5,08](#) [SH06-3,81](#) [SH08-5,08](#) [SH08-](#)  
[5,08-K](#) [SH12-5,08](#) [SHS04-5,00](#) [30.303](#) [30.305](#) [30.306](#) [PHP09-5,08](#) [25.193.0453.0](#) [25.320.4653.1](#) [25.332.2453.1](#)