



NOTES1:

UL Standard

1. Rated voltage/current : 300V / 14.5A
2. Withstanding voltage : AC1600V/1Min.
3. Wire range : 28~14AWG
4. Ratings : Use group B 300V AC/DC
Use group D 300V AC/DC

NOTES2:

1. Dimension shall be interpreted per ASME Y14.5-2009
2. Pitch : 5.0mm, Poles : N=02~14P
3. Stripping length : 8~9mm
4. Operating temperature: -40°C~+105°C
5. Undimensioned tolerances:

Pitch range in mm		Nominal dimension range in mm								
TO	Over	TO	Over	TO	Over	TO	0.1/10			
6	6	10	10	30	30	60	100	150		
		10	24	30	60	100	150			
		±0.15	±0.20	±0.30	±0.30	±0.50	±0.70	±1.00	±1.30	±2'

6. RoHS Compliance

REVISION RECORD				
REV	ECN	DESCRIPTION	DRFT	DATE

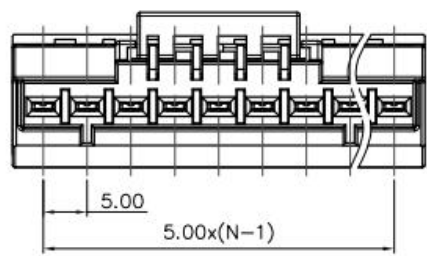
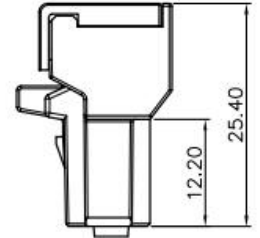
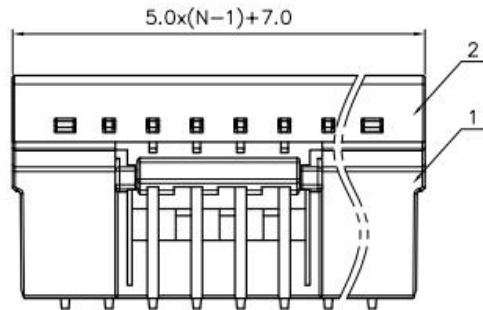
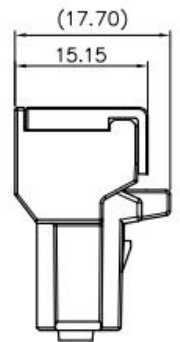
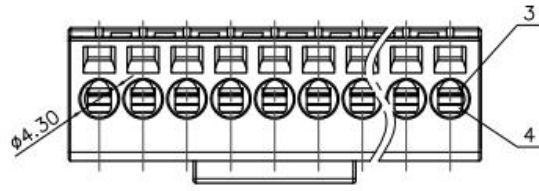

Ordering Information

JL9EDGK - 500 XX B 0 1

Pitch 500=5.00PH No. of pins 2P-15P Housing Color B=Black G=Green U=Blue R=Red W=White Y=Yellow D=Orange E=Grey Packing 0=Pe bag A=Tray T=Tube

ITEM	NAME OF PART	MATERIAL	NOTES
4	Spring	Stainless Steel	
3	Clamp	Copper alloy	Sn/Au Plated
2	Cover	PA66+GF	UL94V-0
1	Housing	PA66+GF	UL94V-0

DRAW	LICHAO LIU	SCALE	FIT
CHECK	LICHAO LIU	UNIT	mm
APPROVE	G. Y. L	SIZE	A4
		SHEET	1/1
		PROJ.	◆

JILN 东莞市锦凌电子有限公司
DONGGUAN JINLING ELECTRONIC CO.,LTD

PART NO.	JL9EDGK-500XXB01
TITLE:	JL9EDGK-5.0母端/接线端子台

HSF RoHS COMPLIANT

REVISION RECORD				
REV	ECN	DESCRIPTION	DRFT	DATE

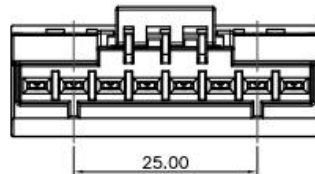
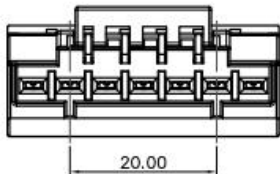
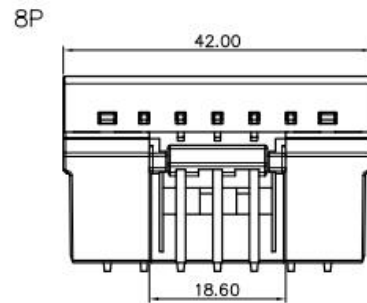
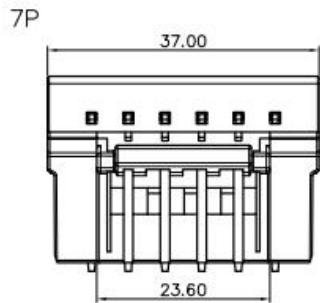
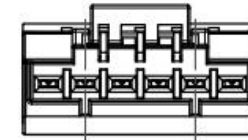
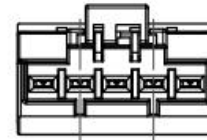
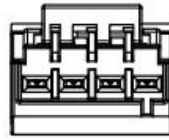
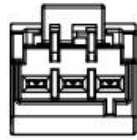
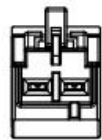
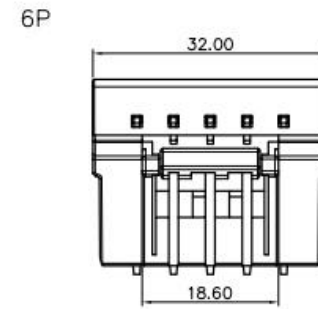
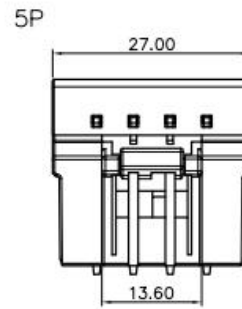
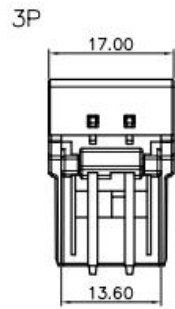
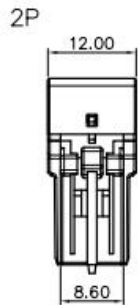

DRAW	Z. S. P	SCALE	FIT
		UNIT	mm
CHECK	LICHAO LIU	SIZE	A4
		SHEET	2/4
APPROVE	G. Y. L	PROJ.	◆

JILN 东莞市锦凌电子有限公司
DONGGUAN JINLING ELECTRONIC CO., LTD

PART NO.	JL9EDGK-500XB01
TITLE:	JL9EDGK-5.0母端/接线端子台

HSF RoHS  **US**

REVISION RECORD				
REV	ECN	DESCRIPTION	DRFT	DATE

9P

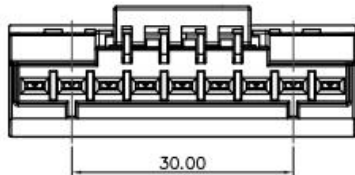
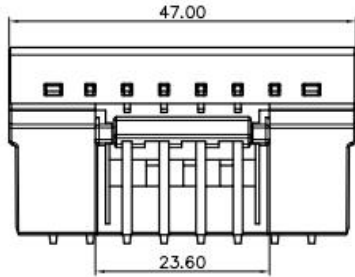

10P

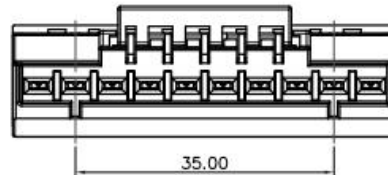
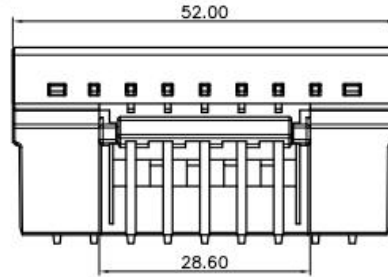

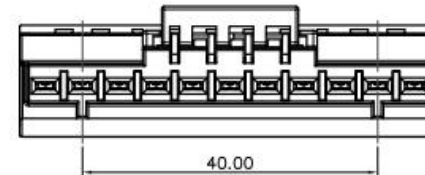
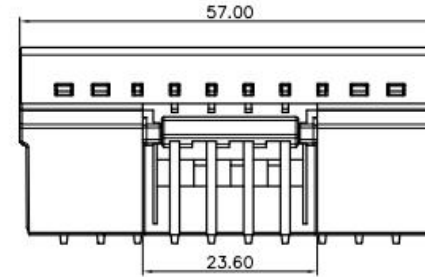

11P

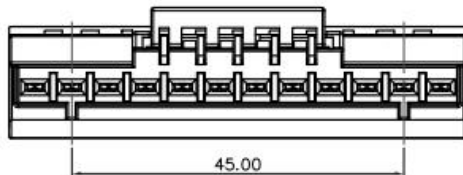
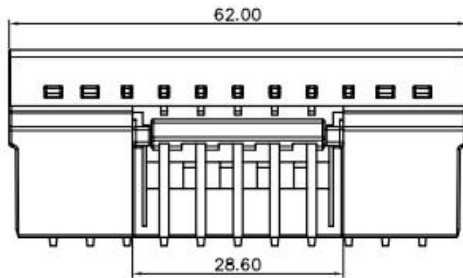

12P



DRAW	Z. S. P	SCALE	FIT	 东莞市锦凌电子有限公司 DONGGUAN JINLING ELECTRONIC CO., LTD	
CHECK	LICHAO LIU	UNIT	mm		
APPROVE	G. Y. L	SIZE	A4		
		SHEET	3/4		
		PROJ.		PART NO.	JL9EDGK-500XXB01
				TITLE:	JL9EDGK-5.0母端/接线端子台

HSF RoHS  us

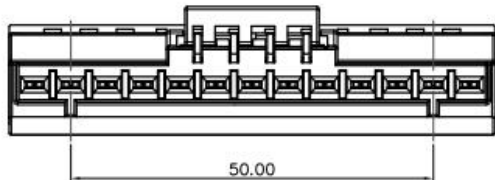
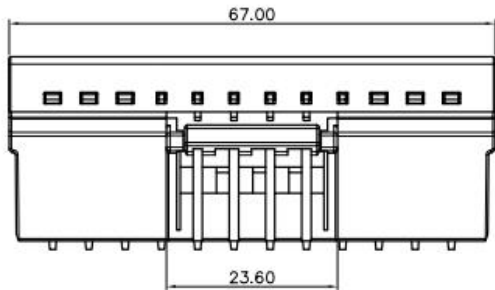

REVISION RECORD				
REV	ECN	DESCRIPTION	DRFT	DATE

13P

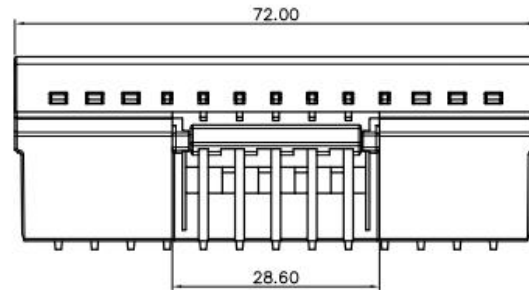

14P



DRAW	Z. S. P	SCALE	FIT	 东莞市锦凌电子有限公司 DONGGUAN JINLING ELECTRONIC CO., LTD	
CHECK	LICHAO LIU	UNIT	mm		
APPROVE	G. Y. L	SIZE	A4		
		SHEET	4/4		
		PROJ.		PART NO.	JL9EDGK-500XXB01
				TITLE:	JL9EDGK-5.0母端/接线端子台

X-ON Electronics

Largest Supplier of Electrical and Electronic Components

Click to view similar products for [Pluggable Terminal Blocks](#) category:

Click to view products by [JILN](#) manufacturer:

Other Similar products are found below :

[57.510.0053](#) [MC 1.5/ 6-ST-3.5 GY AU](#) [ET02015000J0G](#) [734-104](#) [734-302](#) [860505](#) [860516](#) [860810](#) [GBPACX-12](#) [93.731.4953.0](#) [PV05-5,08-K](#) [PVP03-3,50](#) [PVP04-3,50](#) [PVS02-5,00](#) [1-1986160-3](#) [1377680000](#) [1531000000](#) [1546228-5](#) [ELFP03110](#) [ELFT07250](#) [ELVD12100](#) [ELVF09400](#) [ELVP03100](#) [ELXH071G0E](#) [1700410](#) [1702246](#) [1705229](#) [1714537](#) [1717806](#) [1719600](#) [1728941](#) [1734692](#) [1734795](#) [1740291](#) [1740628](#) [1746952](#) [1750207](#) [1752865](#) [1754115](#) [1754144](#) [1756913](#) [1760051](#) [1760336](#) [1765111](#) [1776388](#) [1777701](#) [1783410](#) [1800227](#) [1801080](#) [1809474](#)