

防水塑胶PC

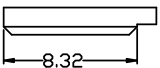

材质：硅胶

- 电气特性:Electrical:
1. 额定电流: Current Rating  
1.5A/contact terminal
  2. 额定电压: Voltage Rating  
30V DC
  3. 接触阻抗: Contact Resistance  
30 milliohms MAX
  4. 耐电压: Dielectric Withstanding Voltage:  
500 V AC AT Sea Level
  5. 绝缘阻抗: Insulation Resistance:  
1000MEGA ohms MIN
- 物理性能:Mechanical:
1. 插拔力: Connector Mate and Unmate Force  
Mate force: 3.57kgf (MAX)  
Umate force: 0.7kgf (MIN)
  2. 端子保持力: Terminal Retention  
1.2kgf (MIN)
  3. 寿命: 1500次
- 原材料:Material:
1. 塑胶:Housing:PBT 白胶
  2. 端子:Contact:Copper Alloy C2680
  3. 外壳:Shell:C2680
- 电镀:Finish:
1. 端子Contact: Au 0.7u" Plated on contact area  
Tin50u" Plated on solder area  
Nickel 50u" Plated underplating over all.
  2. 外壳Shell: Nickel 50u" Min plating over all.

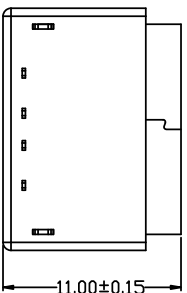
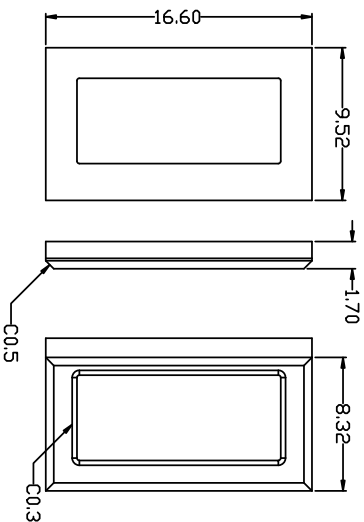
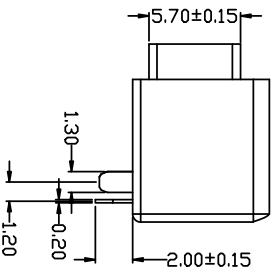
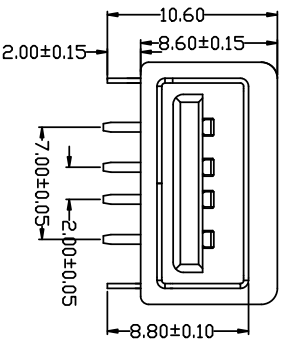
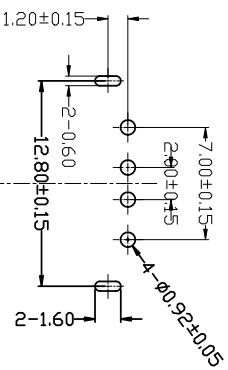

FRONT EDGE OF CONNECTOR  
PCB LAYOUT (T=1.60mm)

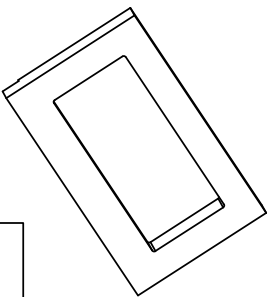

深圳市精拓金电子有限公司

Pin NUMBER	SIGNAL NAME
1	VBUS
2	D-
3	D+
4	GND

公差一览表	
公差	公差
±0.30	±5.°
±0.25	±2.°
±0.15	±1.°
±0.10	±0.5°

单位	比例	日期	制图	审核	核准	制图料号	产品名称	角法	版本
UNITS	SCALE	DATE	DRAWING	CHKD	APPD	PRODUCT PART NO.	PRODUCT NO.	VIEW	VER
MM	1:1	2019.11.23	林属升	郭志富	黄园荣	911-272B1016D10201	AF100D 数后两直脚无边无弹铜壳 反向BT 自胶S、2DIP/防水+防水	⊕	A0

## X-ON Electronics

Largest Supplier of Electrical and Electronic Components

*Click to view similar products for [USB Connectors](#) category:*

*Click to view products by [Jing](#) manufacturer:*

Other Similar products are found below :

[950](#) [A-USB A-LP-SMT-C](#) [A-USB B-TOP-C](#) [MUSBD11135](#) [17-200721](#) [217450-1](#) [KMBVX-TH-5S-B30](#) [KUSBX-AS2N-W](#) [KUSBX-SMT2AP1S-W30](#) [935](#) [957](#) [30-498-6](#) [SK-60A-2](#) [1734082-1](#) [30-470](#) [30-489](#) [30-541](#) [MAB 5 S](#) [A-USB A-2P-C](#) [MIKROE-1451](#)  
[USBFTVSCCG](#) [1-1734084-2](#) [MUSBA81130](#) [NK-27-32SL](#) [NK-L8-22C-5/8](#) [10135326-001LF](#) [4198](#) [690-024-633-031](#) [UB-20PMFP-LC7001](#)  
[17-200011](#) [UB-20AFMM-LL7A01](#) [CAP-WCCMLPB1](#) [CAP-WCCMLPC1](#) [2274475-3](#) [914-614A2025S10200](#) [USB3FTV7SAGF059](#)  
[USB3FTV2SAZNF459](#) [USB3FTV7SAZNF459](#) [HYCW153-USBD05-500B](#) [HYCW148-USBD05-117B](#) [HYCW149-USBD05-740B](#)  
[HYCW214-USBA04-113B](#) [HYCW213-USBA04-113B](#) [KMMX-BSMT35S-1-B30TR](#) [2345986-1](#) [10082141-N340LF](#) [10117836-011LF](#)  
[GSB3C3133DSYHR](#) [GT-USB-2014-CWG1](#) [GT-USB-7010ANS](#)