

RoHS

MAPX

MODIFICATION

DRW

DATE

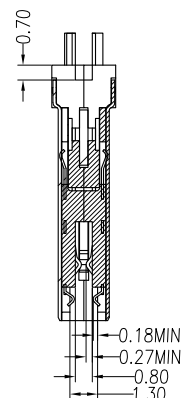
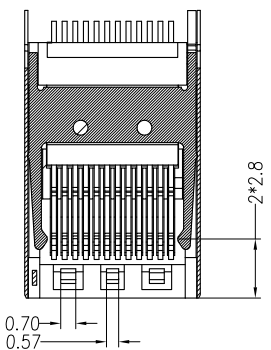
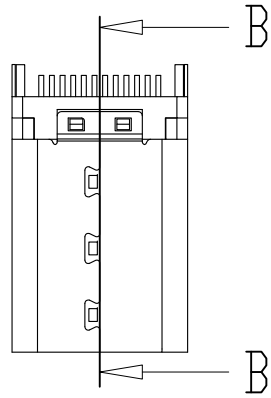
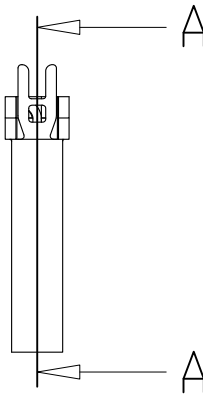
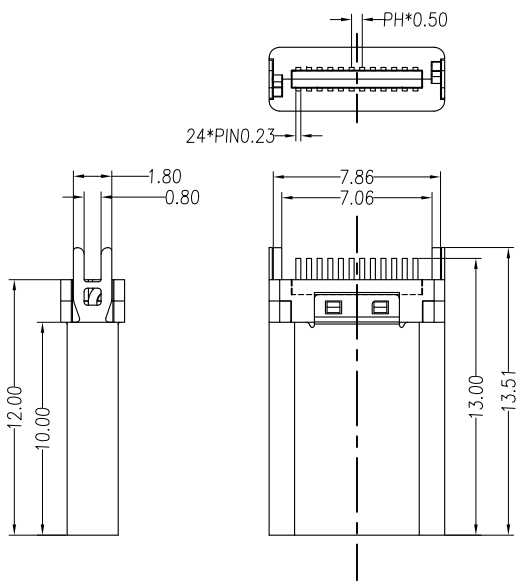

剖面 A-A  
比例 1:1

剖面 B-B  
比例 1:1

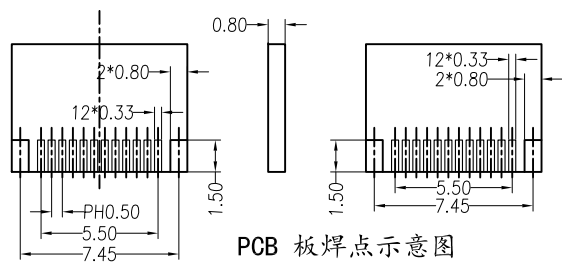
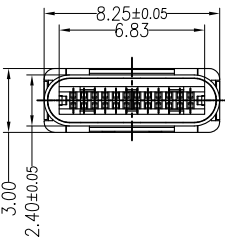

材料:Material:

1. 塑胶: Housing: High Temperature Thermoplastics, LCP 耐高温塑胶
2. 端子: Contact: Copper Alloy 磷铜
3. 外壳: Shell: Copper Alloy 不锈钢
4. 卡钩: Shell: Copper Alloy 不锈钢
5. 弹片: Shell: Copper Alloy 不锈钢

电镀:Finish:

1. 端子: Contact: Plated Gold in Mating Area; Tin On Solder Falls  
接触点镀金, 焊脚镀锡。  
电镀类型: 1U"、3U"、15U"、30U"

产品图 PRODUCT CHART DWG				深圳市精拓金电子有限公司 Shenzhen Jing Tuo Jin Electronics Co., Ltd.						
公差一览表 TOLERANCE UNLESS OTHERWISE				单位 UNITS	MM	制图 DRAWING	尹先华	制图料号 PRODUCT PART NO.	918-118A2021Y40005	
X.	±0.35	X.	±5°	比例 SCALE	1:1	审核 CHKD	郭治富	产品名称 PRODUCT NO.	TYPE-C3.1公头冲压款立式10.0 12.0夹板0.8 LCP 黑胶 24PIN	
.X	±0.25	.X	±2°	日期 DATE	2021-04-15	核准 APPD	黄国荣	角法 VIEW	版本 VER	A0
.XX	±0.20	.XX	±1°							
.XXX	±0.10	.XXX	±0.5°							

## X-ON Electronics

Largest Supplier of Electrical and Electronic Components

*Click to view similar products for [USB Connectors](#) category:*

*Click to view products by [Jing](#) manufacturer:*

Other Similar products are found below :

[950](#) [A-USB A-LP-SMT-C](#) [A-USB B-TOP-C](#) [MUSBD11135](#) [17-200721](#) [217450-1](#) [KMBVX-TH-5S-B30](#) [KUSBX-AS2N-W](#) [KUSBX-SMT2AP1S-W30](#) [935](#) [957](#) [30-498-6](#) [SK-60A-2](#) [1734082-1](#) [30-470](#) [30-489](#) [30-541](#) [MAB 5 S](#) [A-USB A-2P-C](#) [MIKROE-1451](#)  
[USBFTVSCCG](#) [1-1734084-2](#) [MUSBA81130](#) [NK-27-32SL](#) [NK-L8-22C-5/8](#) [10135326-001LF](#) [4198](#) [690-024-633-031](#) [UB-20PMFP-LC7001](#)  
[17-200011](#) [UB-20AFMM-LL7A01](#) [CAP-WCCMLPB1](#) [CAP-WCCMLPC1](#) [2274475-3](#) [914-614A2025S10200](#) [USB3FTV7SAGF059](#)  
[USB3FTV2SAZNF459](#) [USB3FTV7SAZNF459](#) [HYCW153-USBD05-500B](#) [HYCW219-USBD05-075B](#) [HYCW148-USBD05-117B](#)  
[HYCW149-USBD05-740B](#) [HYCW204-USBD05-108B](#) [HYCW214-USBA04-113B](#) [HYCW213-USBA04-113B](#) [KMMX-BSMT35S-1-B30TR](#)  
[2345986-1](#) [10082141-N340LF](#) [10117836-011LF](#) [GSB3C3133DSYHR](#)