

目錄	變更內容	日期

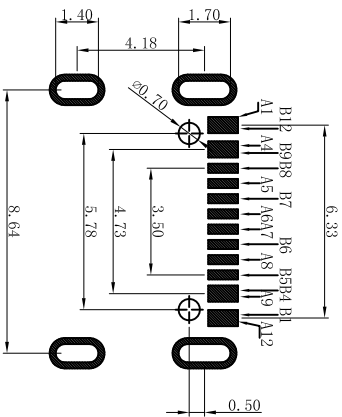
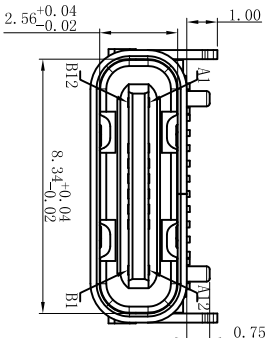
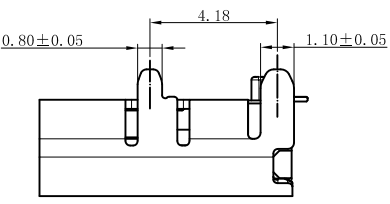
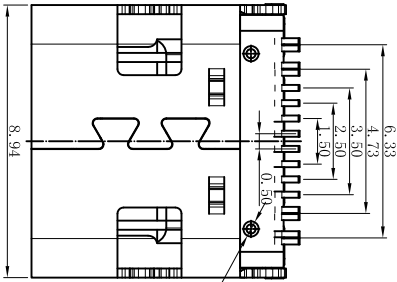
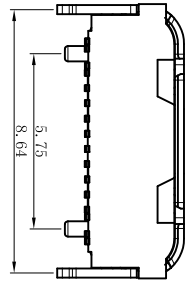
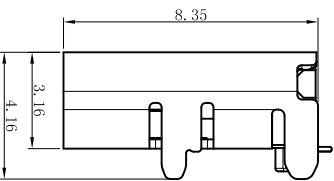
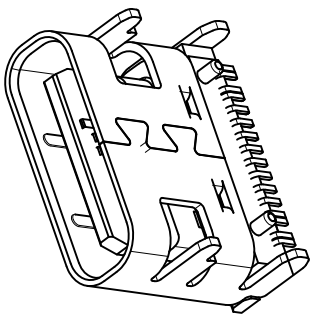

A1	GND	B12	GND
A4	VBUS	B9	VBUS
A5	CC1	B8	SBU2
A6	DP1	B7	DN2
A7	DN1	B6	DP2
A8	SBU1	B5	CC2
A9	VBUS	B4	VBUS
A12	GND	B1	GND
PIN	SIGNAL NAME	PIN	SIGNAL NAME

- NOTES:
- MECHANICAL: MATING FORCE: 5-20N .  
UNMATING FORCE: 8-20N .  
DURABILITY: 10000 CYCLES MIN.
  - ELECTRICAL:  
CURRENT: 5.0A MAX  
VOLTAGE: 20V MAX  
WITHSTANDING VOLTAGE: 100V AC  
CONTACT RESISTANCE: 40 mΩ MAX INITIAL;  
50 mΩ MAX AFTER 10000 CYCLES
  - ENVIRONMENTAL:  
OPERATING TEMPERATURE RANGE -30° C ~ +80° C  
4. Salt Spray: 48H

序号	名称	材料规格
1	Terminal	C7025 TM02 T=0.15mm 电镀合金 Au:6F Ni:50u"
2	Terminal	C7025 TM02 T=0.15mm 电镀合金 Au:6F Ni:50u"
3	Molding 1	LCP+30%KG, F黑色 U194 V-0
4	Molding 2	LCP+30%KG, F黑色 U194 V-0
5	Molding 3	LCP+30%KG, F黑色 U194 V-0
6	Shell	SUS301 L/2H T=0.30mm Ni:50u"

# 深圳市精拓金电子有限公司

产品图		制图		产品料号	918-418K2023S40038
公差一览表		张如波		产品名称	
TOLERANCE UNLESS OTHERWISE		单位	MM	比例	1:1
X	±0.35	X'	±5'	日期	2022/05/10
XX	±0.50	X''	±3'	核准	黄国荣
XXX	±0.25	XXX'	±1'	角法	按图
	±0.20	XXX''	±0.5'	版本	A0

## X-ON Electronics

Largest Supplier of Electrical and Electronic Components

*Click to view similar products for [USB Connectors](#) category:*

*Click to view products by [Jing](#) manufacturer:*

Other Similar products are found below :

[950](#) [A-USB A-LP-SMT-C](#) [A-USB B-TOP-C](#) [MUSBD11135](#) [17-200721](#) [217450-1](#) [KMBVX-TH-5S-B30](#) [KUSBX-AS2N-W](#) [KUSBX-SMT2AP1S-W30](#) [935](#) [957](#) [30-498-6](#) [SK-60A-2](#) [1734082-1](#) [30-470](#) [30-489](#) [30-541](#) [MAB 5 S](#) [A-USB A-2P-C](#) [MIKROE-1451](#)  
[USBFTVSCCG](#) [1-1734084-2](#) [MUSBA81130](#) [NK-27-32SL](#) [NK-L8-22C-5/8](#) [10135326-001LF](#) [4198](#) [690-024-633-031](#) [UB-20PMFP-LC7001](#)  
[17-200011](#) [UB-20AFMM-LL7A01](#) [CAP-WCCMLPB1](#) [CAP-WCCMLPC1](#) [2274475-3](#) [914-614A2025S10200](#) [USB3FTV7SAGF059](#)  
[USB3FTV2SAZNF459](#) [USB3FTV7SAZNF459](#) [HYCW153-USBD05-500B](#) [HYCW219-USBD05-075B](#) [HYCW148-USBD05-117B](#)  
[HYCW149-USBD05-740B](#) [HYCW204-USBD05-108B](#) [HYCW214-USBA04-113B](#) [HYCW213-USBA04-113B](#) [KMMX-BSMT35S-1-B30TR](#)  
[2345986-1](#) [10082141-N340LF](#) [10117836-011LF](#) [GSB3C3133DSYHR](#)