

由 Autodesk 教育版产品制作

MAPX	MODIFICATION	DATE
------	--------------	------

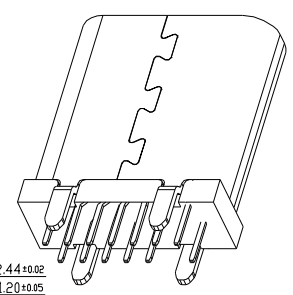

- SPECIFICATIONS:
- ELECTRICAL CHARACTERISTICS:
 - 1-1. CONTACT RESISTANCE: 30mΩ MAX.
 - 1-2. DIELECTRIC WITHSTANDING VOLTAGE: 100V AC FOR ONE MINUTE.
 - 1-3. INSULATION RESISTANCE: 100MΩ MIN. MEASURED BY 500 VDC
 - MECHANICAL CHARACTERISTICS:
 - 2-1. INSERTION FORCE :0.5-2.0kgf<REF.>
 - 2-2. WITHDRAWAL FORCE :0.8-2.0kgf<REF.>
 - LIFE TEST: 10,000 CYCLES.
 - TO CONFORM TO THE KRCDNN HAZARDOUS SUBSTANCE FREE SPEC.

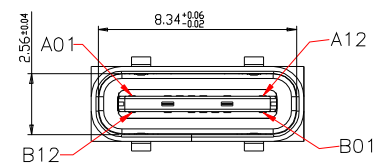
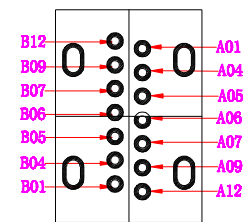
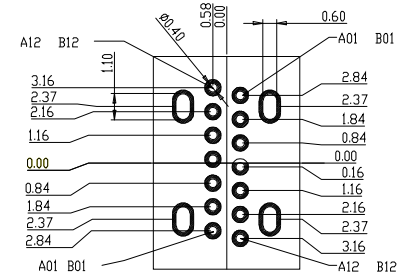
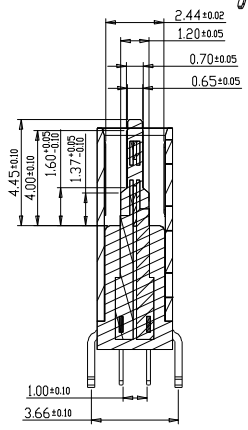
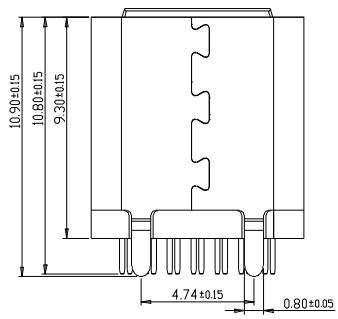

A1	GND	B12	GND
A4	VBUS	B9	VBUS
A5	CC1		
A6	DP1	B7	DN2
A7	DN1	B6	DP2
		B5	CC2
A9	VBUS	B4	VBUS
A12	GND	B1	GND
PIN	SIGNAL NAME	PIN	SIGNAL NAME

截面 1-1

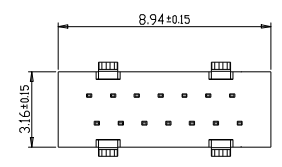

6	SHELL	STAINLESS STEEL	Ni Plated	1PCS
5	SHIELDING PLATE	STAINLESS STEEL	---	1PCS
4	MD	HIGH TEMPERATURE PLASTIC	BLACK	1PCS
3	CONTACT	COPPER ALLOY	Au/Ni Plated	1SET
2	CONTACT	COPPER ALLOY	Au/Ni Plated	1SET
1	HOUSING	HIGH TEMPERATURE PLASTIC	BLACK	1PCS
NO.	DESCRIPTION	MATERIAL	REMARKS	QTY

产品图
PRODUCT CHART DWG

公差一览表
TOLERANCE UNLESS OTHERWISE

X.	±0.30	X.	±5.°
.X	±0.25	.X	±2.°
.XX	±0.15	.XX	±1.°
.XXX	±0.10	.XXX	±0.5°

深圳市精拓金电子有限公司

单位 UNITS	MM	制图 DRAWING	YANG	制图料号 PRODUCT PART NO.
比例 SCALE	1:1	审核 CHKD	郭志富	产品名称 PRODUCT NO.
日期 DATE	2019.11.23	核准 APPD	黄国荣	角法 VIEW
				版本 VER
				AD

TYPE C 14P母座180度 H=9.3

X-ON Electronics

Largest Supplier of Electrical and Electronic Components

Click to view similar products for [USB Connectors](#) category:

Click to view products by [Jing](#) manufacturer:

Other Similar products are found below :

[10033527-N3112MLF](#) [17-210561](#) [GMCB05B11124H1EU](#) [17-200931](#) [65-647-8-BK-BU](#) [690-010-295-484](#) [73725-1191BLF](#) [950](#) [E8144-B01021-L](#) [A-USB A-LP-SMT-C](#) [A-USB B-TOP-C](#) [MUSBA511N5](#) [MUSBB15131](#) [MUSBC111M5](#) [MUSBD11135](#) [217450-1](#) [CA 6 W LD](#) [896-30-004-00-000000](#) [KUSBVX-BS1N-W30](#) [KUSBX-AP-KIT-SCBLK](#) [KUSBX-AS2N-W](#) [KUSBX-SMT2AP1S-W](#) [KUSBX-SMTAS1NBTR](#) [KUSBX-SMTBS1NBTR](#) [30-498-6](#) [SK-60A-2](#) [17-200261](#) [17-210051](#) [1734082-1](#) [FK-37-32SL](#) [30-1574](#) [30-470](#) [30-489](#) [30-541](#) [30-572-3](#) [30-9503](#) [M9177/2-1](#) [MAB 5 S](#) [MIKROE-1451](#) [33UBBR-04SW11R](#) [USBFTV2PEM2G](#) [USBFTVC6ZN](#) [USBFTVSCCG](#) [KUSBX-AS2N-W30](#) [KUSBX-SLAS1N-W](#) [KUSBX-SLAS1N-W30](#) [1-1734084-2](#) [E8110-001-01](#) [MUSBC11135](#) [NK-27-32SL](#)