

MAPX	MODIFICATION	DATE

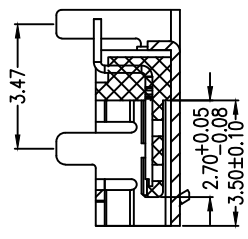

SECTION A-A

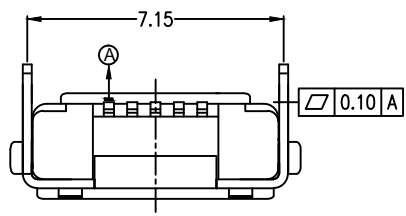
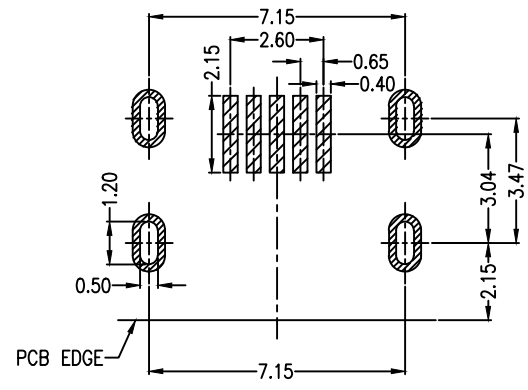
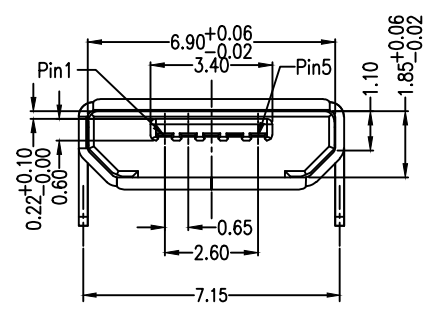
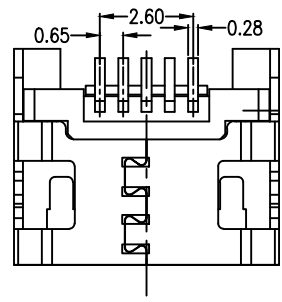
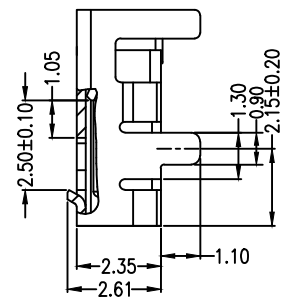
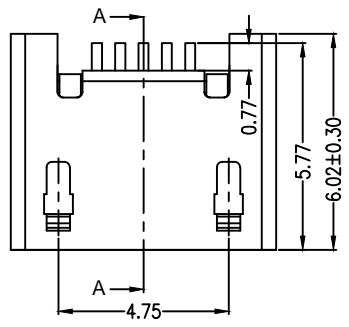

RECOMMENDED PCB LAYOUT
PCB图仅供参考

- Note:
- Material:
 - Housing: High temperature thermoplastic with g.f,UL94v-0
 - Contact: copper alloy,t=0.20mm
 - Shell: copper alloy or SUS,t=0.25mm
 - Specification:
 - Current rating:1.5PIN 1.8A Max/2,3,4PIN 1A Max.
 - Dielectric withstanding voltage: 100 V(ac) for 1 min.
 - Contact resistance: 30 mΩ Max.
 - Insulation resistance: 100 MΩ Min.
 - Total mating force: 3.57 Kgf Max.
 - Total unmating force: 1.0 Kgf Min.
 - Temperature range: -30°C~80°C

???		深圳市精拓金电子有限公司							
PRODUCT CHART DWG		?? UNITS		MM	?? DRAWING	YANG	???? PRODUCT PART NO.	920-A62A2021S10106	
TOLERANCE UNLESS OTHERWISE		?? SCALE	1:1	?? CHKD	???	???? PRODUCT NO.	MICRO 5P-F B型四脚插板7.2无卷边无柱端子加长0.75		
X.	±0.30	X.	±5.°	?? DATE	2019.11.23	?? APPD	???	?? VIEW	AD
.X	±0.25	.X	±2.°						
.XX	±0.20	.XX	±1.°						
.XXX	±0.10	.XXX	±0.5°						

X-ON Electronics

Largest Supplier of Electrical and Electronic Components

Click to view similar products for [USB Connectors](#) category:

Click to view products by [Jing](#) manufacturer:

Other Similar products are found below :

[950](#) [A-USB A-LP-SMT-C](#) [A-USB B-TOP-C](#) [MUSBD11135](#) [17-200721](#) [217450-1](#) [KMBVX-TH-5S-B30](#) [KUSBX-AS2N-W](#) [KUSBX-SMT2AP1S-W30](#) [935](#) [957](#) [30-498-6](#) [SK-60A-2](#) [1734082-1](#) [30-470](#) [30-489](#) [30-541](#) [MAB 5 S](#) [A-USB A-2P-C](#) [MIKROE-1451](#)
[USBFTVSCCG](#) [1-1734084-2](#) [MUSBA81130](#) [NK-27-32SL](#) [NK-L8-22C-5/8](#) [10135326-001LF](#) [4198](#) [690-024-633-031](#) [UB-20PMFP-LC7001](#)
[17-200011](#) [UB-20AFMM-LL7A01](#) [CAP-WCCMLPB1](#) [CAP-WCCMLPC1](#) [2274475-3](#) [914-614A2025S10200](#) [USB3FTV7SAGF059](#)
[USB3FTV2SAZNF459](#) [USB3FTV7SAZNF459](#) [HYCW153-USBD05-500B](#) [HYCW219-USBD05-075B](#) [HYCW148-USBD05-117B](#)
[HYCW149-USBD05-740B](#) [HYCW204-USBD05-108B](#) [HYCW214-USBA04-113B](#) [HYCW213-USBA04-113B](#) [KMMX-BSMT35S-1-B30TR](#)
[2345986-1](#) [10082141-N340LF](#) [10117836-011LF](#) [GSB3C3133DSYHR](#)