

7	8	9	10
MAPX	MODIFICATION		DATE

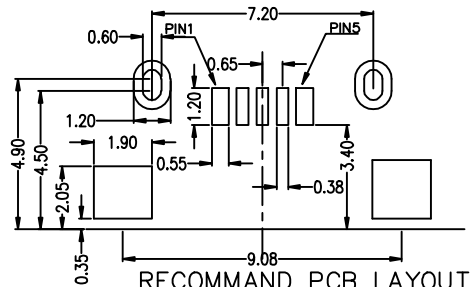
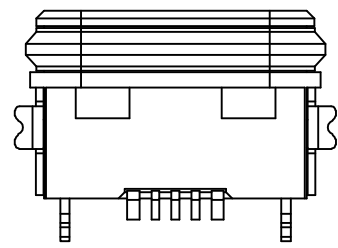
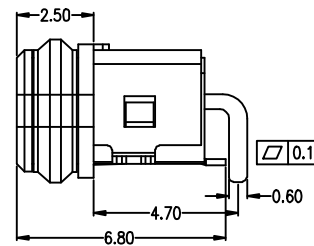
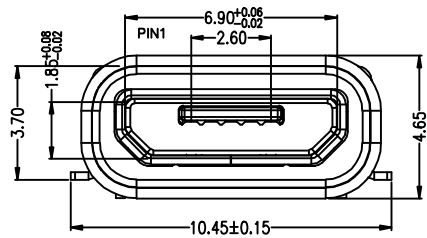
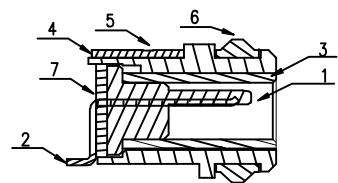
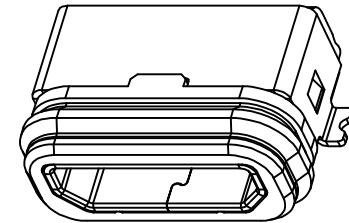
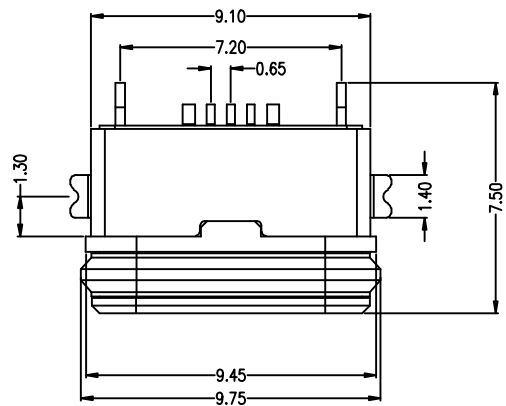

- Note:
- Material:
 - Housing: High temperature thermoplastic
 - Contact: copper alloy, t=0.20mm
 - Shell: SUS304, t=0.30mm
 - cover: High temperature thermoplastic
 - out Shell: SUS304 T=0.25
 - Ring: SILICON
 - Epoxy: Epoxy
 - Specification:
 - Current rating: 1,5PIN 2.0A Max/2,3,4PIN 1A Max.
 - Dielectric withstanding voltage: 100 V(ac) for 1 min.
 - Contact resistance: 30 mΩ Max.
 - Insulation resistance: 100 MΩ Min.
 - Total mating force: 3.57 Kgf Max.
 - Total unmating force: 1.0 Kgf Min.
 - Temperature range: -30°C~80°C
 - Waterproof: IPX 7.

产品图 PRODUCT CHART DWG 公差一览表 TOLERANCE UNLESS OTHERWISE		深圳市精拓金电子有限公司							
X.	±0.30 X.	±5.°	单位	MM	制图	YANG	制图料号	920-A64A2021S101A0	
.X	±0.25 .X	±2.°	比例	1:1	审核	郭志富	产品名称	KING OF THE MARKET NO.1A 100VAC 10A 1000VDC	
.XX	±0.15 .XX	±1.°	日期	2019.11.23	核准	黄国荣	产品图号	角法	
.XXX	±0.10 .XXX	±0.5'	DATE	2019.11.23	APPD	黄国荣	角法	版本	A0

X-ON Electronics

Largest Supplier of Electrical and Electronic Components

Click to view similar products for [USB Connectors](#) category:

Click to view products by [Jing](#) manufacturer:

Other Similar products are found below :

[950](#) [A-USB A-LP-SMT-C](#) [A-USB B-TOP-C](#) [MUSBA511N5](#) [MUSBC111M5](#) [MUSBD11135](#) [17-200721](#) [217450-1](#) [KMBVX-TH-5S-B30](#)
[896-30-004-00-000000](#) [KUSBX-AS2N-W](#) [KUSBX-SMT2AP1S-W30](#) [935](#) [957](#) [30-498-6](#) [SK-60A-2](#) [1734082-1](#) [30-1574](#) [30-470](#) [30-489](#) [30-](#)
[541](#) [30-572-3](#) [A-USB A-2P-C](#) [MIKROE-1451](#) [USBFTV2PEM2G](#) [USBFTVSCCG](#) [4689-1](#) [1-1734084-2](#) [MUSBC11135](#) [USBF21ZNSCC](#)
[USBBFTV6ZC](#) [MUSBB151341](#) [10135326-001LF](#) [M9177/3-1](#) [TJ-105](#) [USB-A-S-F-B-VT](#) [4198](#) [690-024-633-031](#) [UB-20PMFP-LC7001](#)
[USBFTVC6MRG](#) [UA-20BMFA-SL8001](#) [17-200011](#) [USBFTVC7ZC](#) [UB-20AFMM-LL7A01](#) [USBFTVC2MN](#) [CAP-WCCMLPB1](#) [1310-](#)
[1031-01](#) [2041386-1](#) [2274475-3](#) [UB-20BMFA-SL8001](#)