

ROHS

MAPX	MODIFICATION	DRW	DATE

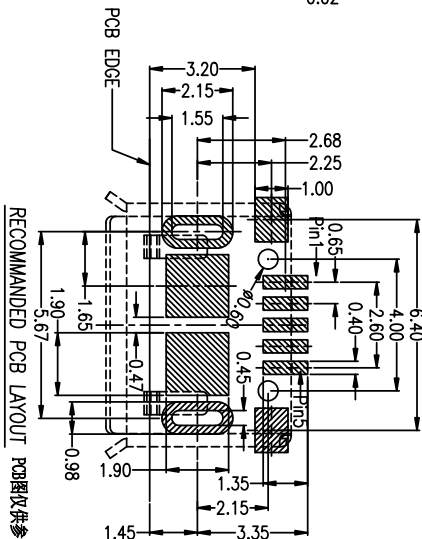
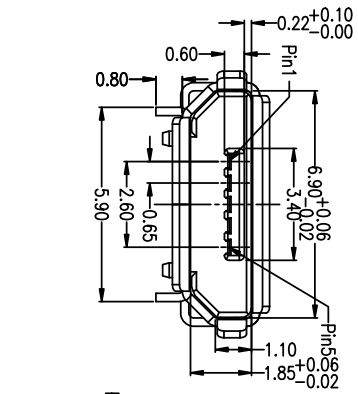
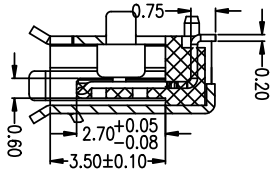
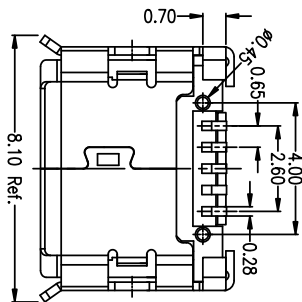
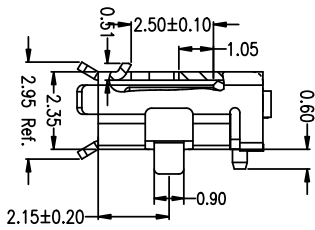
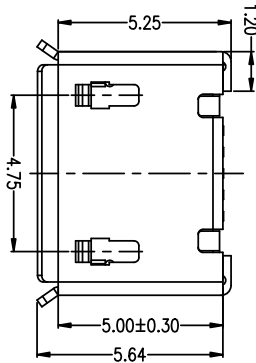
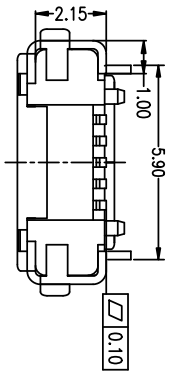

- Note:
- 1.Material:
- 1.1 Housing: LCP J1L94V-0
 - 1.2 Contact: copper alloy,t=0.20mm contact area Au flash plating;
 - 1.3 Shell:copper or SUS304,t=0.25mm Sn plating 60U" min.
- 2.Specification:
- 2.1 Current rating:1.5PIN 1.8A Max/2,3,4PIN 1A Max.
 - 2.2 Dielectric withstanding voltage: 100 V(ac) for 1 min.
 - 2.3 Contact resistance: 30 mΩ Max.
 - 2.4 Insulation resistance: 100 MΩ Min.
 - 2.5 Total mating force: 3.57 Kgf Max.
 - 2.6 Total unmating force: 1.0 Kgf Min.
 - 2.7 Temperature range: -30°C~80°C
 - 2.8 Solderability: 90% area min;

5	GND
4	ID
3	D+
2	D-
1	VBUS
	PIN NAME
	PIN ASSIGNMENT

产品图

PRODUCT CHART DWG
公差一览表

深圳市精拓金电子有限公司
Shenzhen Jing Tuo Jin Electronics Co., Ltd.

公差一览表	单位	MM	制图	林属升	制图料号	920-052A2021S10113
TOLERANCE UNLESS OTHERWISE	UNITS	MM	DRAWING	林属升	PRODUCT PART NO.	920-052A2021S10113
X ±0.35	X	±0.35	审核	郭治富	产品名称	USB 2.0 母座
X ±0.25	X	±0.25	CHKD	郭治富	PRODUCT NO.	920-052A2021S10113
XX ±0.20	XX	±0.20	核准	黄国荣	角法	ISO 275
XXX ±0.15	XXX	±0.15	DATE	2016-09-09	VER	A0

X-ON Electronics

Largest Supplier of Electrical and Electronic Components

Click to view similar products for [USB Connectors](#) category:

Click to view products by [Jing](#) manufacturer:

Other Similar products are found below :

[950](#) [MUSBD11135](#) [17-200721](#) [217450-1](#) [KMBVX-TH-5S-B30](#) [KUSBX-AS2N-W](#) [KUSBX-SMT2AP1S-W30](#) [935](#) [957](#) [30-498-6](#) [SK-60A-2](#)
[1734082-1](#) [30-470](#) [30-489](#) [30-541](#) [A-USB A-2P-C](#) [MIKROE-1451](#) [USBFTVSCCG](#) [1-1734084-2](#) [10135326-001LF](#) [4198](#) [USB-A-D-VT](#)
[USB-A-S-RA-TSMT](#) [1310-1023-02](#) [690-024-633-031](#) [UB-20PMFP-LC7001](#) [17-200011](#) [UB-20AFMM-LL7A01](#) [1040870124](#) [CAP-](#)
[WCCMLPB1](#) [CAP-WCCMLPC1](#) [2274475-3](#) [UB-20BMFA-SL8001](#) [914-614A2025S10200](#) [USB3FTV7SAGF059](#) [ZX40-B-5S-1500-](#)
[STDA\(30\)](#) [GSB3116344HR](#) [USB3FTV2SAZNF459](#) [USB3FTV7SAZNF459](#) [U221-041N-1WVS62-F5D](#) [HYCW153-USBD05-500B](#)
[HYCW219-USBD05-075B](#) [HYCW148-USBD05-117B](#) [HYCW149-USBD05-740B](#) [HYCW204-USBD05-108B](#) [HYCW214-USBA04-113B](#)
[HYCW213-USBA04-113B](#) [UB-20AMFM-SL7A01](#) [KMMX-BSMT35S-1-B30TR](#) [2345986-1](#)