

MAPX	MODIFICATION	DATE

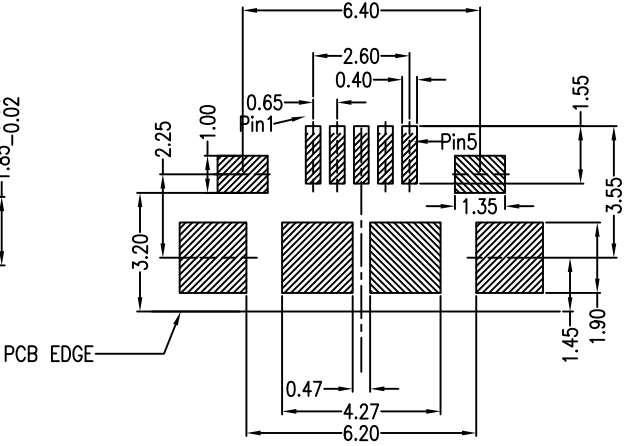
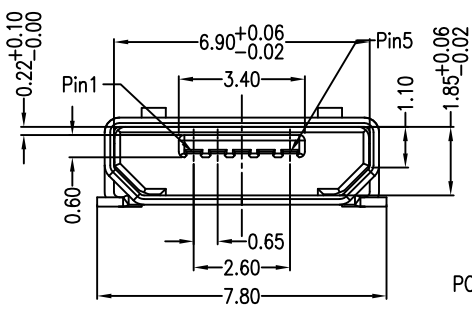
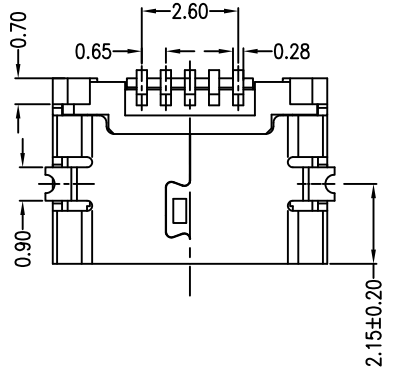
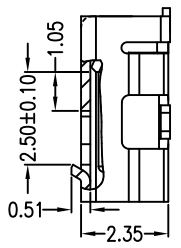
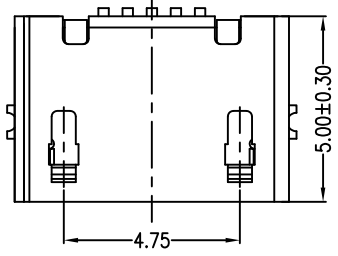
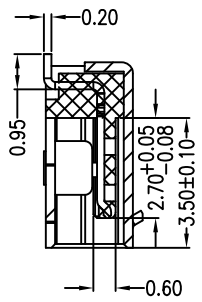
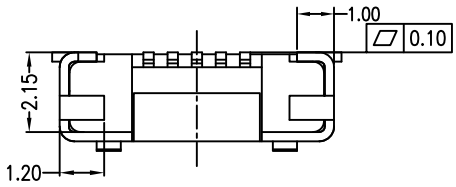

- Note:
- Material:
    - Housing: High temperature thermoplastic with g.f,UL94v-0
    - Contact: copper alloy,t=0.20mm
    - Shell: copper or sus304,t=0.25mm
  - Specification:
    - Current rating:1,5PIN 1.8A Max/2,3,4PIN 1A Max.
    - Dielectric withstanding voltage: 100 V(ac) for 1 min.
    - Contact resistance: 30 mΩ Max.
    - Insulation resistance: 100 MΩ Min.
    - Total mating force: 3.57 Kgf Max.
    - Total unmating force: 1.0 Kgf Min
    - Temperature range: -30°C~80°C

RECOMMENDED PCB LAYOUT PCB图仅供参考

产品图 PRODUCT CHART DWG				深圳市精拓金电子有限公司						
公差一览表 TOLERANCE UNLESS OTHERWISE				单位 UNITS	MM	制图 DRAWING	尹先华	制图料号 PRODUCT PART NO.	920-D62A2021S10104	
X	±0.30	X	±5.°	比例 SCALE	1:1	审核 CHKD	郭治富	产品名称 PRODUCT NO.	MICRO 5P B型两脚贴片无边无柱加焊脚 SMD加长0.2	
.X	±0.25	.X	±2.°	日期 DATE	2021-04-16	核准 APPD	黄国荣	角法 VIEW	版本 VER	AO
.XX	±0.15	.XX	±1.°							
.XXX	±0.10	.XXX	±0.5°							

## X-ON Electronics

Largest Supplier of Electrical and Electronic Components

*Click to view similar products for [USB Connectors](#) category:*

*Click to view products by [Jing](#) manufacturer:*

Other Similar products are found below :

[950](#) [A-USB A-LP-SMT-C](#) [A-USB B-TOP-C](#) [MUSBD11135](#) [17-200721](#) [217450-1](#) [KMBVX-TH-5S-B30](#) [KUSBX-AS2N-W](#) [KUSBX-SMT2AP1S-W30](#) [935](#) [957](#) [30-498-6](#) [SK-60A-2](#) [1734082-1](#) [30-470](#) [30-489](#) [30-541](#) [MAB 5 S](#) [A-USB A-2P-C](#) [MIKROE-1451](#)  
[USBFTVSCCG](#) [1-1734084-2](#) [MUSBA81130](#) [NK-27-32SL](#) [NK-L8-22C-5/8](#) [10135326-001LF](#) [4198](#) [690-024-633-031](#) [UB-20PMFP-LC7001](#)  
[17-200011](#) [UB-20AFMM-LL7A01](#) [CAP-WCCMLPB1](#) [CAP-WCCMLPC1](#) [2274475-3](#) [914-614A2025S10200](#) [USB3FTV7SAGF059](#)  
[USB3FTV2SAZNF459](#) [USB3FTV7SAZNF459](#) [HYCW153-USBD05-500B](#) [HYCW148-USBD05-117B](#) [HYCW149-USBD05-740B](#)  
[HYCW214-USBA04-113B](#) [HYCW213-USBA04-113B](#) [KMMX-BSMT35S-1-B30TR](#) [2345986-1](#) [10082141-N340LF](#) [10117836-011LF](#)  
[GSB3C3133DSYHR](#) [GT-USB-2014-CWG1](#) [GT-USB-7010ANS](#)