

MAPX	MODIFICATION	DATE
------	--------------	------

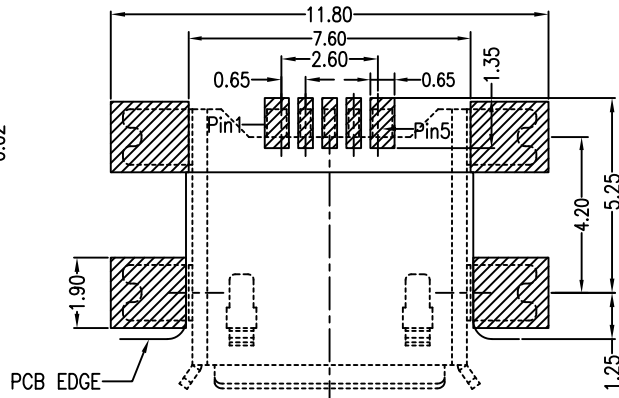
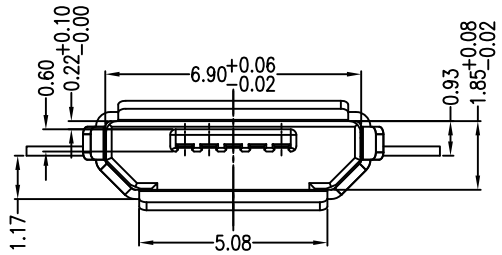
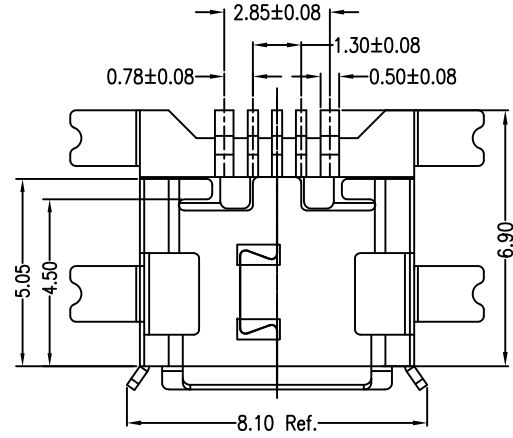
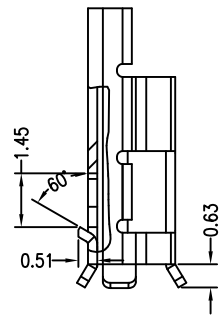
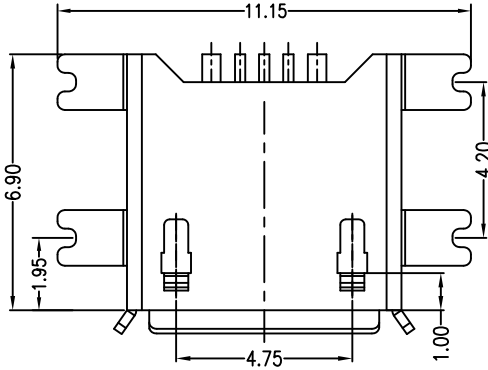
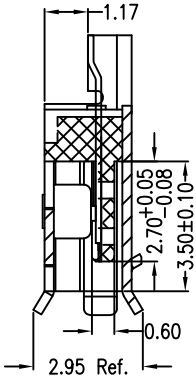
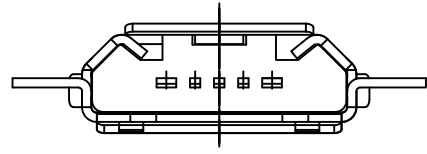

RECOMMENDED PCB LAYOUT  
PCB图仅供参考

- Note:
- Material:
    - Housing: High temperature thermoplastic with g.f,UL94v-0
    - Contact: copper alloy,t=0.15mm
    - Shell: copper alloy,t=0.25mm
  - Specification:
    - Current rating: 3A Max.
    - Dielectric withstanding voltage: 100 V(ac) for 1 min.
    - Contact resistance: 30 mΩ Max.
    - Insulation resistance: 100 MΩ Min.
    - Total mating force: 3.57 Kgf Max.
    - Total unmating force: 1.0 Kgf Min.
    - Temperature range: -30°C~80°C

产品图 PRODUCT CHART DWG		深圳市精拓金电子有限公司							
公差一览表 TOLERANCE UNLESS OTHERWISE		单位 UNITS	MM	制图 DRAWING	尹先华	制图料号 PRODUCT PART NO.	920-F52A2021S10200		
X.	±0.30	X.	±5.°	比例 SCALE	1:1	审核 CHKD	郭治富	产品名称 PRODUCT NAME	MICRO USB 5S B型沉板1.17有边短端
.X	±0.25	.X	±2.°	日期 DATE	2021-04-16	核准 APPD	黄国荣	角法 VIEW	角法
.XX	±0.15	.XX	±1.°					版本 VER	AD
.XXX	±0.10	.XXX	±0.5°						

## X-ON Electronics

Largest Supplier of Electrical and Electronic Components

*Click to view similar products for [USB Connectors](#) category:*

*Click to view products by [Jing](#) manufacturer:*

Other Similar products are found below :

[950](#) [MUSBD11135](#) [17-200721](#) [217450-1](#) [KMBVX-TH-5S-B30](#) [KUSBX-AS2N-W](#) [KUSBX-SMT2AP1S-W30](#) [935](#) [957](#) [30-498-6](#) [SK-60A-2](#)  
[1734082-1](#) [30-470](#) [30-489](#) [30-541](#) [A-USB A-2P-C](#) [MIKROE-1451](#) [USBFTVSCCG](#) [1-1734084-2](#) [10135326-001LF](#) [4198](#) [USB-A-D-VT](#)  
[USB-A-S-RA-TSMT](#) [1310-1023-02](#) [690-024-633-031](#) [UB-20PMFP-LC7001](#) [17-200011](#) [UB-20AFMM-LL7A01](#) [1040870124](#) [CAP-](#)  
[WCCMLPB1](#) [CAP-WCCMLPC1](#) [2274475-3](#) [UB-20BMFA-SL8001](#) [914-614A2025S10200](#) [USB3FTV7SAGF059](#) [ZX40-B-5S-1500-](#)  
[STDA\(30\)](#) [GSB3116344HR](#) [USB3FTV2SAZNF459](#) [USB3FTV7SAZNF459](#) [U221-041N-1WVS62-F5D](#) [HYCW153-USBD05-500B](#)  
[HYCW219-USBD05-075B](#) [HYCW148-USBD05-117B](#) [HYCW149-USBD05-740B](#) [HYCW204-USBD05-108B](#) [HYCW214-USBA04-113B](#)  
[HYCW213-USBA04-113B](#) [UB-20AMFM-SL7A01](#) [KMMX-BSMT35S-1-B30TR](#) [2345986-1](#)