

MAPX	MODIFICATION	DATE

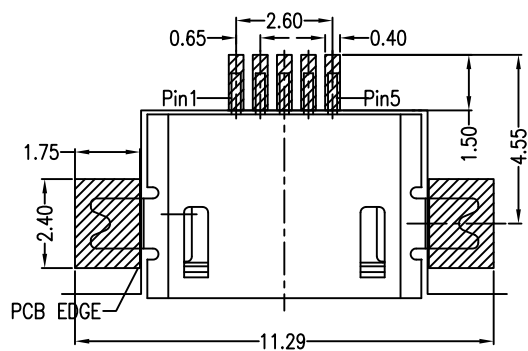

RECOMMENDED PCB LAYOUT
PCB图仅供参考

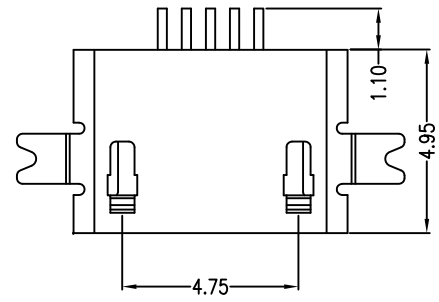
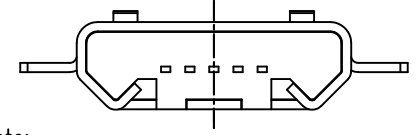
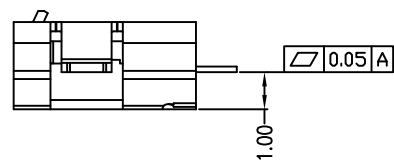
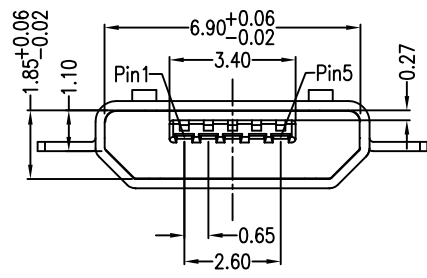
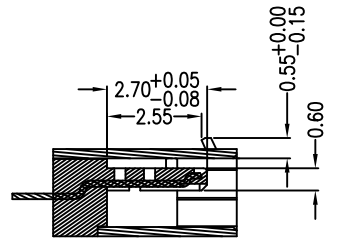

- Note:
- Material:
 - Housing: High temperature thermoplastic with g.f,UL94v-0
 - Contact: copper alloy,t=0.15mm
 - Shell: copper alloy,t=0.25mm
 - Specification:
 - Current rating:1,5PIN 1.8A Max/2,3,4PIN 1A Max.
 - Dielectric withstanding voltage: 100 V(ac) for 1 min.
 - Contact resistance: 30 mΩ Max.
 - Insulation resistance: 100 MΩ Min.
 - Total mating force: 3.57 Kgf Max.
 - Total unmating force: 1.0 Kgf Min.
 - Temperature range: -30°C~80°C

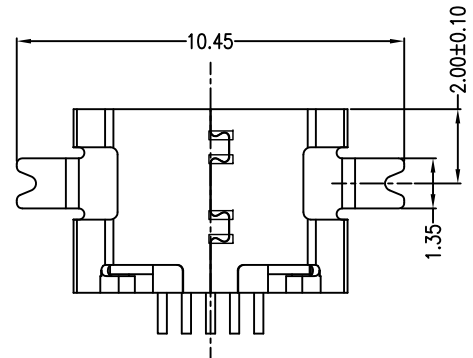

产品图 PRODUCT CHART DWG				深圳市精拓金电子有限公司							
公差一览表 TOLERANCE UNLESS OTHERWISE				单位 UNITS	MM	制图 DRAWING	尹先华	制图料号 PRODUCT PART NO.	920-F62A2021S10107		
X.	±0.30	X.	±5.°	比例 SCALE	1:1	审核 CHKD	郭治富	产品名称 PRODUCT NO.	MICRO 5S B型沉板式1.0两脚贴板无边LCP黑胶SMT端子1.1		
.X	±0.25	.X	±2.°	日期 DATE	2021-04-16	核准 APPD	黄国荣	角法 VIEW		版本 VER	AO
.XX	±0.15	.XX	±1.°								
.XXX	±0.10	.XXX	±0.5°								

X-ON Electronics

Largest Supplier of Electrical and Electronic Components

Click to view similar products for [USB Connectors](#) category:

Click to view products by [Jing](#) manufacturer:

Other Similar products are found below :

[950](#) [MUSBD11135](#) [17-200721](#) [217450-1](#) [KMBVX-TH-5S-B30](#) [KUSBX-AS2N-W](#) [KUSBX-SMT2AP1S-W30](#) [935](#) [957](#) [30-498-6](#) [SK-60A-2](#)
[1734082-1](#) [30-470](#) [30-489](#) [30-541](#) [A-USB A-2P-C](#) [MIKROE-1451](#) [USBFTVSCCG](#) [1-1734084-2](#) [10135326-001LF](#) [4198](#) [USB-A-D-VT](#)
[USB-A-S-RA-TSMT](#) [1310-1023-02](#) [690-024-633-031](#) [UB-20PMFP-LC7001](#) [17-200011](#) [UB-20AFMM-LL7A01](#) [1040870124](#) [CAP-](#)
[WCCMLPB1](#) [CAP-WCCMLPC1](#) [2274475-3](#) [UB-20BMFA-SL8001](#) [914-614A2025S10200](#) [USB3FTV7SAGF059](#) [ZX40-B-5S-1500-](#)
[STDA\(30\)](#) [GSB3116344HR](#) [USB3FTV2SAZNF459](#) [USB3FTV7SAZNF459](#) [U221-041N-1WVS62-F5D](#) [HYCW153-USBD05-500B](#)
[HYCW219-USBD05-075B](#) [HYCW148-USBD05-117B](#) [HYCW149-USBD05-740B](#) [HYCW204-USBD05-108B](#) [HYCW214-USBA04-113B](#)
[HYCW213-USBA04-113B](#) [UB-20AMFM-SL7A01](#) [KMMX-BSMT35S-1-B30TR](#) [2345986-1](#)