

ROHS

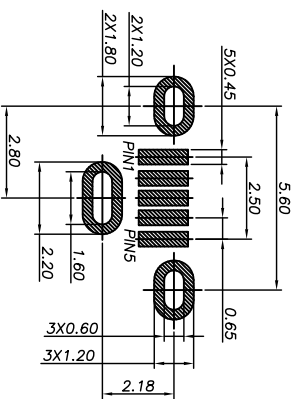

RECOMMENDED PCB LAYOUT(TOP VIEW)
GENERAL TOLERANCES:±0.05

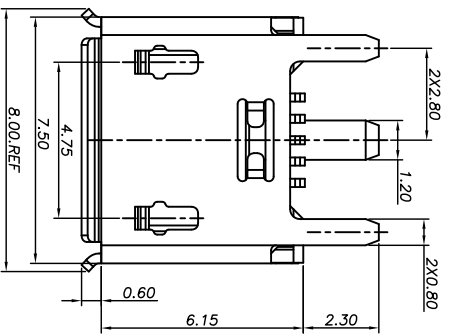
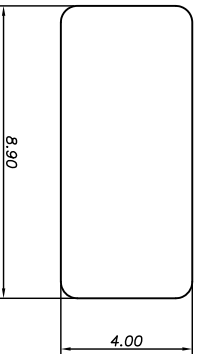
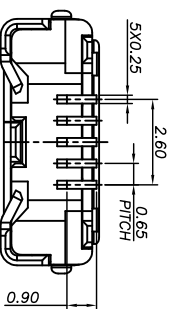
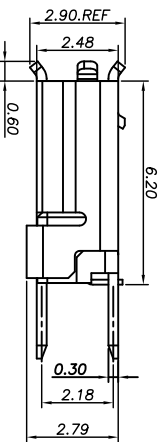
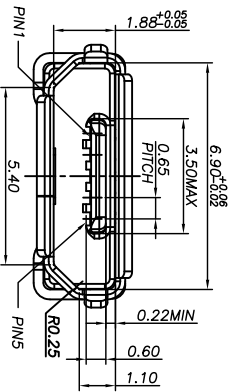

CAP DIMENSION SKETCH MAP

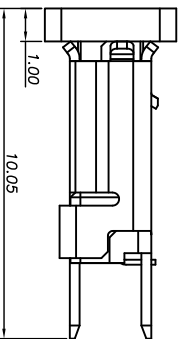

NOTE:

- MATERIAL SPECIFICATION:
 - HOUSING: LCP; UL94 V-0 BLACK.
 - CAP: LCP; UL94 V-0 BLACK.
 - CONTACTS: BRASS.
 - FRONT SHELL: STAINLESS STEEL
- PLATING SPECIFICATION:
 - CONTACTS:
 - 50u" MIN. UNDER PLATED OVER ALL.
 - 1u" MIN PLATED ON THE FUNCTIONAL AREA OF CONTACT.
- MECHANICAL PERFORMANCE.
 - INSERTION FORCE: 3.5kgf MAX
 - REMOVAL FORCE: 0.8kgf MIN
 - DURABILITY: 10000 CYCLES.
- ELECTRICAL PERFORMANCE,
 - CURRENT RATING:
 - VBUS & GND PINS: 1.8A MAX.
 - OTHER PINS: 0.5A MAX.
 - INSULATION RESISTANCE: 100MΩ MIN
 - DIELECTRIC WITHSTAND VOLTAGE: AC 100V FOR 1 MINUTE.

5	GND
4	ID
3	D+
2	D-
1	VBUS
	PIN NAME
	PIN ASSIGNMENT

产品图
PRODUCT CHART DWG

深圳市精拓金电子有限公司

公差一览表		公差一览表	
TOLERANCE UNLESS OTHERWISE		公差一览表	
X	±0.35	X	±5°
X	±0.20	X	±2°
XX	±0.10	XX	±1°
XXX	±0.05	XXX	±0.5°

单位	MM	制图	许榕强	制料号	
UNITS	MM	DRAWING	许榕强	PRODUCT PART NO.	
比例	1:1	审核	郭治富	产品名称	
SCALE	1:1	CHKD	郭治富	PRODUCT NO.	
日期	2016-09-09	核准	黄国荣	角法	
DATE	2016-09-09	APPD	黄国荣	VIEW	
				MICRO USB 5P	
				直立式SWT有翻边外壳3支脚	
				版本	A0
				VER	A0

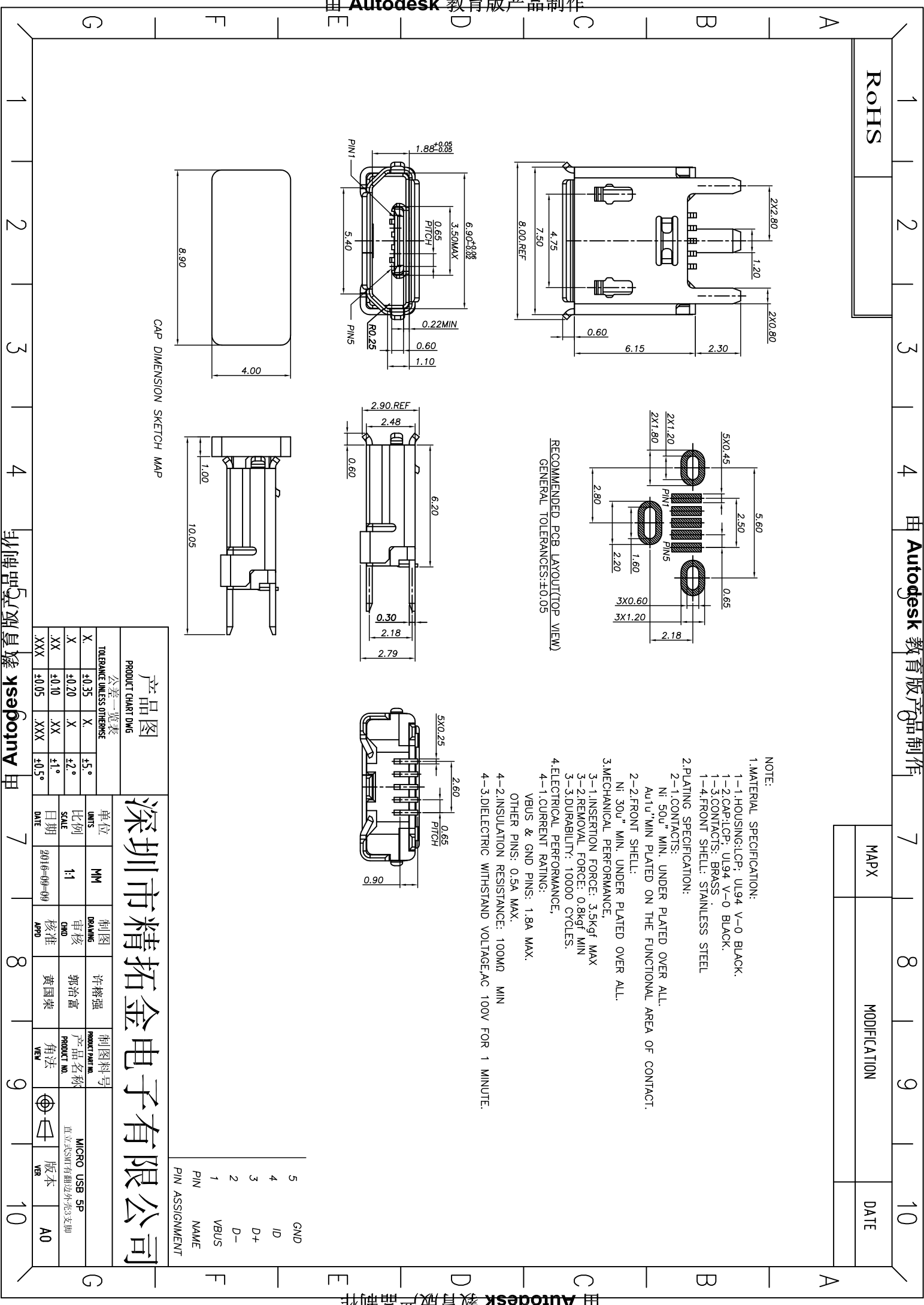

X-ON Electronics

Largest Supplier of Electrical and Electronic Components

Click to view similar products for [USB Connectors](#) category:

Click to view products by [Jing](#) manufacturer:

Other Similar products are found below :

[10033527-N3112MLF](#) [17-210561](#) [GMCB05B11124H1EU](#) [17-200931](#) [65-647-8-BK-BU](#) [690-010-295-484](#) [73725-1191BLF](#) [950](#) [E8144-B01021-L](#) [A-USB A-LP-SMT-C](#) [A-USB B-TOP-C](#) [MUSBA511N5](#) [MUSBB15131](#) [MUSBC111M5](#) [MUSBD11135](#) [217450-1](#) [CA 6 W LD](#) [896-30-004-00-000000](#) [KUSBVX-BS1N-W30](#) [KUSBX-AP-KIT-SCBLK](#) [KUSBX-AS2N-W](#) [KUSBX-SMT2AP1S-W](#) [KUSBX-SMTAS1NBTR](#) [KUSBX-SMTBS1NBTR](#) [30-498-6](#) [SK-60A-2](#) [17-200261](#) [17-210051](#) [1734082-1](#) [FK-37-32SL](#) [30-1574](#) [30-470](#) [30-489](#) [30-541](#) [30-572-3](#) [30-9503](#) [M9177/2-1](#) [MAB 5 S](#) [MIKROE-1451](#) [33UBBR-04SW11R](#) [USBFTV2PEM2G](#) [USBFTVC6ZN](#) [USBFTVSCCG](#) [KUSBX-AS2N-W30](#) [KUSBX-SLAS1N-W](#) [KUSBX-SLAS1N-W30](#) [1-1734084-2](#) [E8110-001-01](#) [MUSBC11135](#) [NK-27-32SL](#)