

REV.	ECH NO	LOCATIONS	DESCRIPTION	DATE

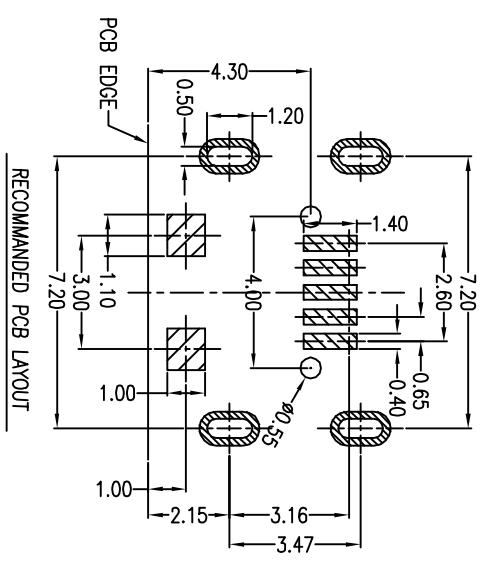
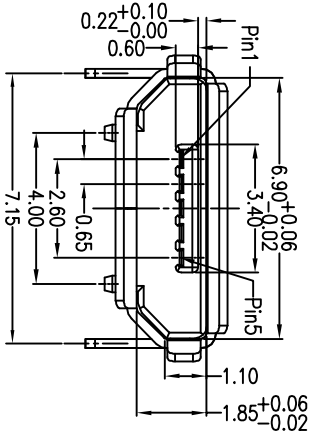
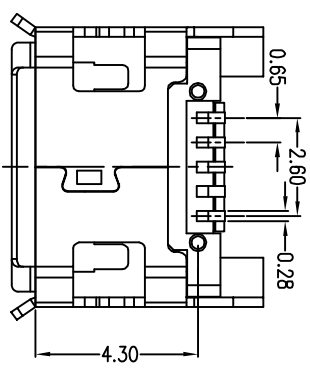
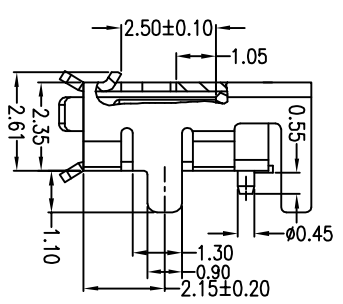
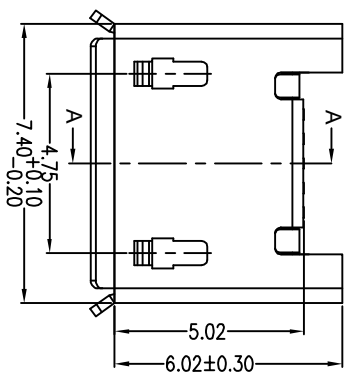
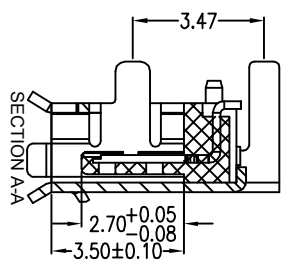
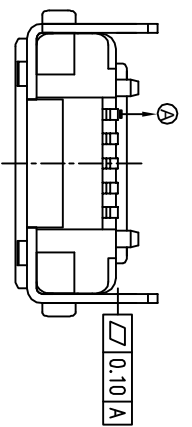

- Note:
- Material:
    - Housing: High temperature thermoplastic with g.f, UL94V-0
    - Contact: copper alloy, t=0.20mm
    - Shell: copper alloy, t=0.25mm
  - Specification:
    - Current rating: 1 A Max. voltage: 100 V(ac) for 1 min.
    - Dielectric withstanding
    - Contact resistance: 50 mW Max.
    - Insulation resistance: 100 MW Min.
    - Total mating force: 3.57 Kgf Max.
    - Total unmating force: 1.0 Kgf Min. 0.81~2.05 Kgf Min.
    - Temperature range: -30°C~80°C

**A 01 S B 1 4 1 B 1-276**

- 产品代号 A: 精品
- 产品系列 01: micro usb 5pin
- 产品类别 S: 母座
- 产品类型 B: B TYPE
- 外壳材料 1: 2980R-H
- 端子材料 4: 5181R-B
- 主体材质 1: LCP
- 主体颜色 B: 黑色
- 下板类型 1: dip (插板)
- 细节流水 2: 8 micro usb 5P/B Type SMT DIP7 2插板板长1.1四脚全插

PART NO: A01SB141B1-276		MATERIAL: SEE NOTE	
MODEL NO: XX		FINISH: SEE NOTE	
UNIT: MM	SIZE: A4	COLOR: SEE NOTE	
TOLERANCE UNSPECIFIED		DR: xiyoulong	
.x	0.15	CHK:	
.xx	0.10	APP:	
.xxx	0.05	SCALE: 5:1	DATE: 2012.05.21
Ang.	↑	DWG NO: A276	REV: A

TITLE: Micro usb 5P/F B Type SMT DIP7 2 有引脚长1.1四脚全插

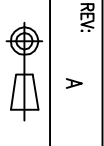

## X-ON Electronics

Largest Supplier of Electrical and Electronic Components

*Click to view similar products for [USB Connectors](#) category:*

*Click to view products by [Jing](#) manufacturer:*

Other Similar products are found below :

[10033527-N3112MLF](#) [17-210561](#) [GMCB05B11124H1EU](#) [17-200931](#) [65-647-8-BK-BU](#) [690-010-295-484](#) [73725-1191BLF](#) [950](#) [E8144-B01021-L](#) [A-USB A-LP-SMT-C](#) [A-USB B-TOP-C](#) [MUSBA511N5](#) [MUSBB15131](#) [MUSBC111M5](#) [MUSBD11135](#) [217450-1](#) [CA 6 W LD](#)  
[896-30-004-00-000000](#) [KUSBVX-BS1N-W30](#) [KUSBX-AP-KIT-SCBLK](#) [KUSBX-AS2N-W](#) [KUSBX-SMT2AP1S-W](#) [KUSBX-SMTAS1NBTR](#) [KUSBX-SMTBS1NBTR](#) [30-498-6](#) [SK-60A-2](#) [17-200261](#) [17-210051](#) [1734082-1](#) [FK-37-32SL](#) [30-1574](#) [30-470](#) [30-489](#) [30-541](#) [30-572-3](#) [30-9503](#) [M9177/2-1](#) [MAB 5 S](#) [MIKROE-1451](#) [33UBBR-04SW11R](#) [USBFTV2PEM2G](#) [USBFTVC6ZN](#) [USBFTVSCCG](#)  
[KUSBX-AS2N-W30](#) [KUSBX-SLAS1N-W](#) [KUSBX-SLAS1N-W30](#) [1-1734084-2](#) [E8110-001-01](#) [MUSBC11135](#) [NK-27-32SL](#)