

REV.	EQN NO	LOCATIONS	DESCRIPTION	DATE	REVISER	APPD

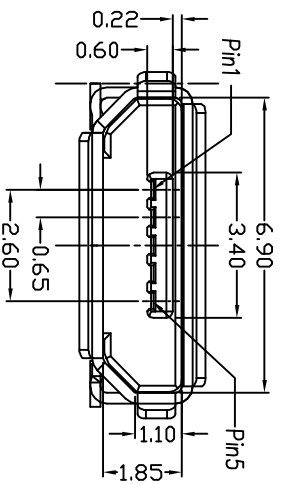
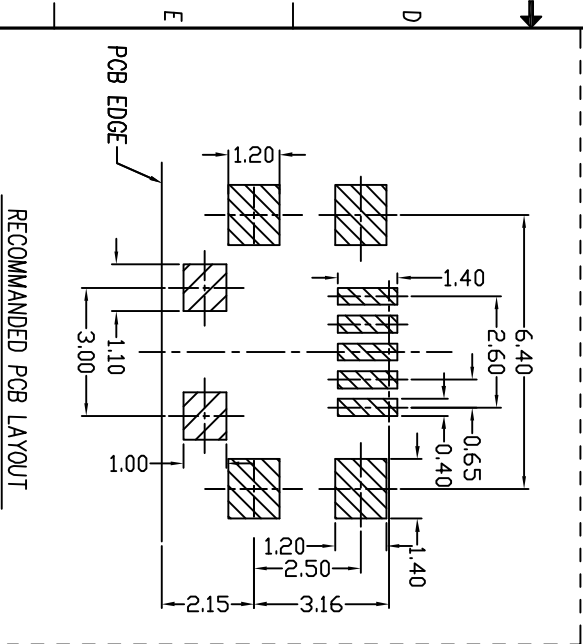
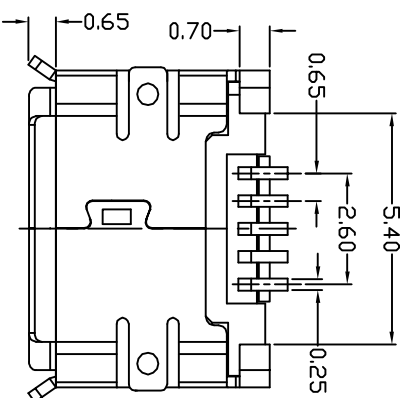
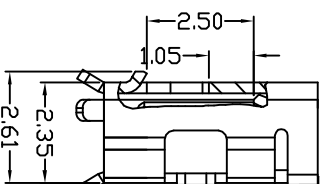
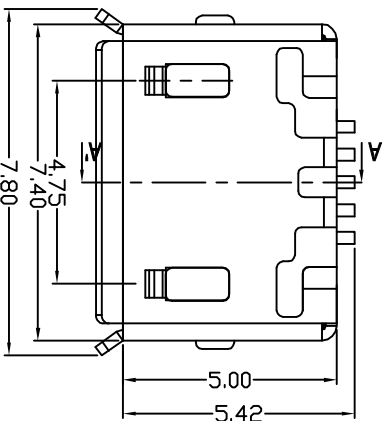
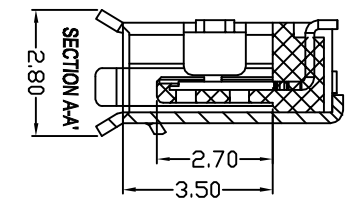
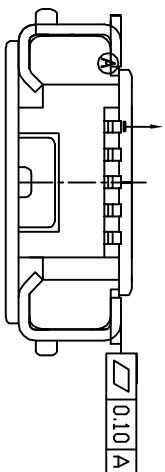

Notes:

1. Materials:
 - 1.1 Housing: High temperature thermoplastic with g.f: UL94 v-0.
 - 1.2 Contact: copper alloy, t=0.20mm, NI 50U", Gold 1U".
 - 1.3 Shell: copper alloy, t=0.25mm, NI 80U", SN 80U".
2. Specifications:
 - 2.1. Current rating: 1 A Max.
 - 2.2. Dielectric withstanding: voltage: 100 V(ac) for 1 min.
 - 2.3. Contact resistance: 50 mW Max.
 - 2.4. Insulation resistance: 100 MW Min.
 - 2.5. Total mating force: 3.57 Kgf Max.
 - 2.6. Total unmating force: 1.0 Kgf Min. 0.81~2.05 Kgf Min. after 10000 insertion/extraction cycles
 - 2.7. Temperature range: -30°C~+80°C

PART NO: 1-MD05SMXXX-01		MATERIAL: SEE NOTE	
MODEL NO:		FINSH: SEE NOTE	
UNIT: mm	SIZE: A4	COLOR: SEE NOTE	TITLE: Micro usb SS B Type (四脚全贴) 有孔型
TOLERANCE UNSPECIFIED		DR: ?/?/?	DWG NO: A107
.x	±0.38	CHK:	REV: A
.xx	±0.25	APP:	SCALE: 1:1
.xxx	±0.13	SHEET: 1/1	REV: A
ANG.	±2°		

No.	Nome	Q'ty	Finish
3	Shell	1	N/A
2	Contact	5	N/A
1	Housing	1	N/A

X-ON Electronics

Largest Supplier of Electrical and Electronic Components

Click to view similar products for [USB Connectors](#) category:

Click to view products by [Jing](#) manufacturer:

Other Similar products are found below :

[10033527-N3112MLF](#) [17-210561](#) [GMCB05B11124H1EU](#) [17-200931](#) [65-647-8-BK-BU](#) [690-010-295-484](#) [73725-1191BLF](#) [950](#) [E8144-B01021-L](#) [A-USB A-LP-SMT-C](#) [A-USB B-TOP-C](#) [MUSBA511N5](#) [MUSBB15131](#) [MUSBC111M5](#) [MUSBD11135](#) [217450-1](#) [CA 6 W LD](#) [896-30-004-00-000000](#) [KUSBVX-BS1N-W30](#) [KUSBX-AP-KIT-SCBLK](#) [KUSBX-AS2N-W](#) [KUSBX-SMT2AP1S-W](#) [KUSBX-SMTAS1NBTR](#) [KUSBX-SMTBS1NBTR](#) [30-498-6](#) [SK-60A-2](#) [17-200261](#) [17-210051](#) [1734082-1](#) [FK-37-32SL](#) [30-1574](#) [30-470](#) [30-489](#) [30-541](#) [30-572-3](#) [30-9503](#) [M9177/2-1](#) [MAB 5 S](#) [MIKROE-1451](#) [33UBBR-04SW11R](#) [USBFTV2PEM2G](#) [USBFTVC6ZN](#) [USBFTVSCCG](#) [KUSBX-AS2N-W30](#) [KUSBX-SLAS1N-W](#) [KUSBX-SLAS1N-W30](#) [1-1734084-2](#) [E8110-001-01](#) [MUSBC11135](#) [NK-27-32SL](#)