

A 01 S B X X X X X 1-045

- ① 产品代号 A: 样品
- ② 产品系列 01: micro usb 5pin
- ③ 产品类别 S: 插座
- ④ 产品类型 B: B TYPE
- ⑤ 产品材质 1: C2880R-H 5: SPC
- ⑥ 外壳电镀 0: 材料: Ni100%; 2: 镀金(100%); 3: Ni+Ni(10%); 4: 镀银
- ⑦ 端子材质 4: C05191R-EH 2: C2880R-EH
- ⑧ 端子电镀 0: 材料: 2: 镀金(100%); 3: 镀银(100%); 4: 镀银
- ⑨ 主体材质 1: LCP
- ⑩ 主体颜色 B: 黑色 W: 白色
- ⑪ 包装方式 1: 载盘管; 2: 卷带; 4: 带载
- ⑫ 下板类型 1: dip (插板)
- ⑬ 细针流水 05: micro usb 5P/B Type dip 有导线长; 2(外壳加焊盘脚长; 1)

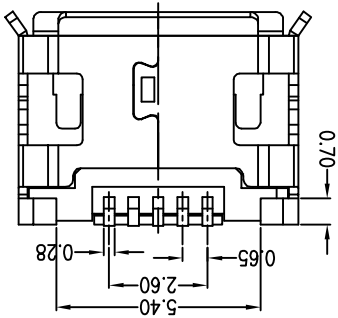
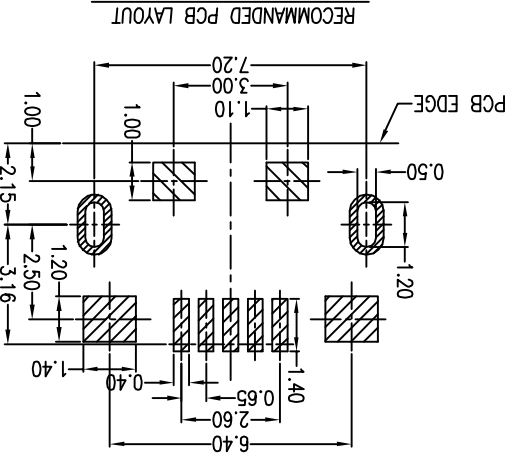
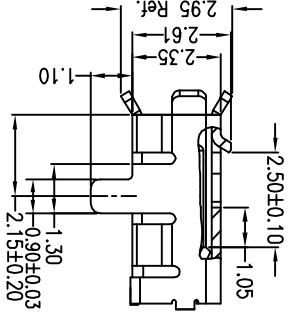
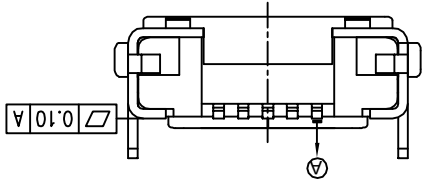
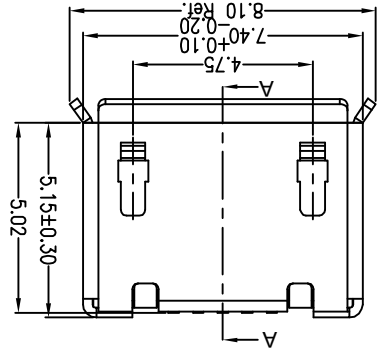
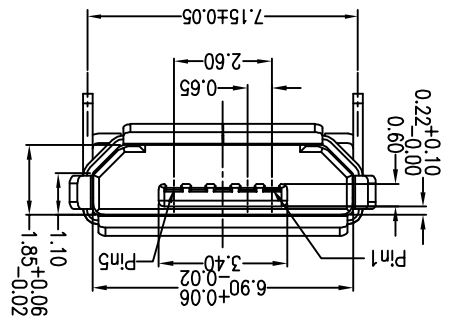
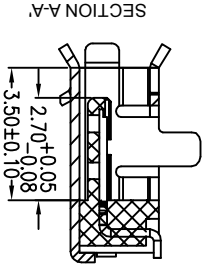

- Note:
1. Material:
 - 1.1 Housing: High temperature thermoplastic with g.f., UL94v-0
 - 1.2 Contact: copper alloy, t=0.20mm
 - 1.3 Shell: copper alloy, t=0.25mm
 2. Specification:
 - 2.1 Current rating: 1 A Max.
 - 2.2 Dielectric withstanding voltage: 100 V(ac) for 1 min.
 - 2.3 Contact resistance: 50 mW Max.
 - 2.4 Insulation resistance: 100 MW Min.
 - 2.5 Total mating force: 3.57 Kgf Max.
 - 2.6 Total unmating force: 1.0 Kgf Min. 0.81~2.05 Kgf Min. after 10000 insertion/extraction cycles
 - 2.7 Temperature range: -30°C~80°C

PART NO.	A01SBXXXXXX1-045	
MODEL NO.	XX	
MATERIAL: SEE NOTE		
FINSH: SEE NOTE		
DR: 夏友红	SIZE: A4	TOLERANCE UNSPECIFIED
CHK: A	APP: 2	.xxx Ang
DWG NO: A045	SCALE: 5:1	DATE: 2012.05.21
REV: A		
TITLE: Micro usb 5P/B Type dip 有导线无柱7.2 (外壳加焊盘脚长1.1)		

REV.	ECN NO	LOCATIONS	DESCRIPTION	DATE

X-ON Electronics

Largest Supplier of Electrical and Electronic Components

Click to view similar products for [USB Connectors](#) category:

Click to view products by [Jing](#) manufacturer:

Other Similar products are found below :

[10033527-N3112MLF](#) [17-210561](#) [GMCB05B11124H1EU](#) [17-200931](#) [65-647-8-BK-BU](#) [690-010-295-484](#) [73725-1191BLF](#) [950](#) [E8144-B01021-L](#) [A-USB A-LP-SMT-C](#) [A-USB B-TOP-C](#) [MUSBA511N5](#) [MUSBB15131](#) [MUSBC111M5](#) [MUSBD11135](#) [217450-1](#) [CA 6 W LD](#)
[896-30-004-00-000000](#) [KUSBVX-BS1N-W30](#) [KUSBX-AP-KIT-SCBLK](#) [KUSBX-AS2N-W](#) [KUSBX-SMT2AP1S-W](#) [KUSBX-SMTAS1NBTR](#) [KUSBX-SMTBS1NBTR](#) [30-498-6](#) [SK-60A-2](#) [17-200261](#) [17-210051](#) [1734082-1](#) [FK-37-32SL](#) [30-1574](#) [30-470](#) [30-489](#) [30-541](#) [30-572-3](#) [30-9503](#) [M9177/2-1](#) [MAB 5 S](#) [MIKROE-1451](#) [33UBBR-04SW11R](#) [USBFTV2PEM2G](#) [USBFTVC6ZN](#) [USBFTVSCCG](#)
[KUSBX-AS2N-W30](#) [KUSBX-SLAS1N-W](#) [KUSBX-SLAS1N-W30](#) [1-1734084-2](#) [E8110-001-01](#) [MUSBC11135](#) [NK-27-32SL](#)