



深圳市晶创和立科技有限公司

SHENZHEN JINGCHUANGHELI TECHNOLOGY CO., LTD.

TEL: +86-755-2321 0829

[Http://www.szichl.com](http://www.szichl.com)

FAX: +86-755-2321 0825

[E-mail:heli@szichl.com](mailto:heli@szichl.com)

广东省 深圳市 龙华新区民治街道牛栏前天宫安防大厦 9CF013 室

Room 9CF013, Temple security building, Niulanqian Minzhi street, Longhua district Shenzhen P. R. C

光敏管 HL504HY 规格书

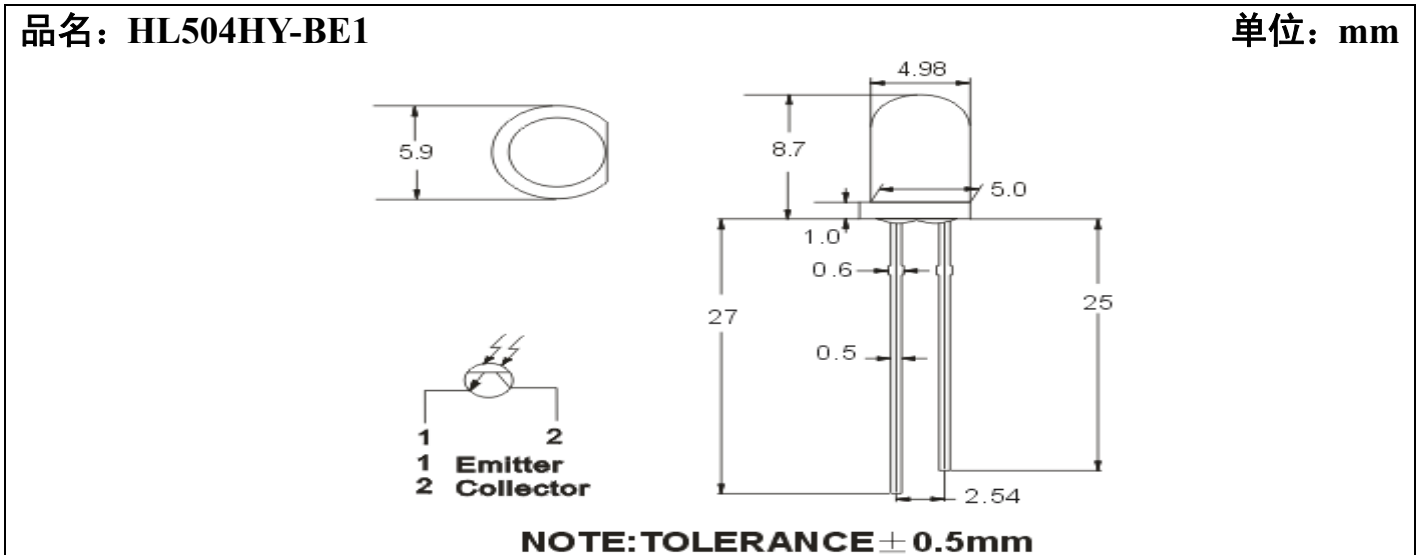

Parameter	Symbol	MIN.	TYP.	MAX.	UNIT	TEST CONDITION
Collector dark current	I_{CEO}			100	nA	$V_{CE}=20V$ $H=0mW/cm^2$
C-E Saturation Voltage	$V_{CE(Sat)}$			0.2	V	$I_C=2mA$ $I_B=100\mu A$
Current gain	h_{FE}	200		1800	uA	$V_{CE}=5V$ $I_C=2mA$
Rise Time(10%to90%)	t_r		15		uS	$V_{CE}=5V$ $I_C=1mA$
Fail Time(90%to10%)	t_f		15			$R_L=100ohms$
Wavelength of Peak Sensitivity	λ_p		940		nm	
Range of Spectral Bandwidth	$\lambda_{0.5}$	400		1200	nm	
Collector-Emitter Breakdown Voltage	V_{CEO}	30			V	$I_C=100\mu A$ $I_B=0$
Emitter-Collector Breakdown Voltage	V_{ECO}	6.5				
Collector Current	I_C		20		mA	
C-Power dissipation	P_C		75		mW	
Collector-base Capacitance	C_{CB}	5.4	6.4	7.4	PF	$f=1MHZ$ $V_{CB}=3V$



深圳市晶创和立科技有限公司

SHENZHEN JINGCHUANGHELI TECHNOLOGY CO., LTD.

TEL: +86-755-2321 0829

[Http://www.szichl.com](http://www.szichl.com)

FAX: +86-755-2321 0825

[E-mail:heli@szichl.com](mailto:heli@szichl.com)

广东省 深圳市 龙华新区民治街道牛栏前天宫安防大厦 9CF013 室

Room 9CF013, Temple security building, Niulanqian Minzhi street, Longhua district Shenzhen P. R. C

Absolute Maximum Ratings

Parameter	Symbol	Rating	Unit
Power Dissipation at (or below) 25 °C Free Air Temperature	Pc	75	mW
Collector-Emitter Voltage	V _{CEO}	30	V
Emitter-Collector Voltage	V _{ECO}	5	V
Collector Current	Ic	20	mA
Operating Temperature	Topr	-25~+85	°C
Storage Temperature	Tstg	-40~+85	°C
Soldering Temperature (1/16 inch from body for 5 seconds)	Tsol	260	°C

Electrical Optical Characteristics:

Parameter	Symbol	Min.	Typ.	Max.	Unit	Test Condition
Collector Dark Current	I _{CEO}			100	nA	I _e =0mW/cm ² V _{CE} =20V
On State Collector Current	I _{C(on)}	0.7	2.0			I _e =1mW/cm ² V _{CE} =5V
Emitter-Collector Breakdown Voltage	BV _{CEO}	30		100	V	I _C =100 μA I _e =0mW/cm ²
Collector - Emitter Breakdown Voltage	BV _{ECO}	6.5			V	I _C =100 μA I _e =0mW/cm ²
Collector-Emitter Saturation Voltage	V _{CE(sat)}			0.2	V	I _C =2mA I _e =1mW/cm ²
Current gain	h _{FE}	800		1800	μA	V _{CE} =5V I _e =2mW/cm ²
Wavelength of Peak Sensitivity	λ _p		940		nm	
Range of Spectral Bandwidth	λ _{0.5}	450		1100	nm	
Response Time	Rise Time		15		μS	V _{CE} =5V I _e =1mA R _L =1000Ω
	Fall Time		15		μS	
Collector-Capacitance	C _{CB}	5.4	6.4	7.4	PF	f=1MHz V _{CB} =3V



TEL: +86-755-2321 0829

[Http://www.szichl.com](http://www.szichl.com)

FAX: +86-755-2321 0825

[E-mail:heli@szichl.com](mailto:heli@szichl.com)

广东省 深圳市 龙华新区民治街道牛栏前天官安防大厦 9CF013 室

Room 9CF013, Temple security building, Niulanqian Minzhi street, Longhua district Shenzhen P. R. C

Typical Electrical-Optical Characteristics Curves

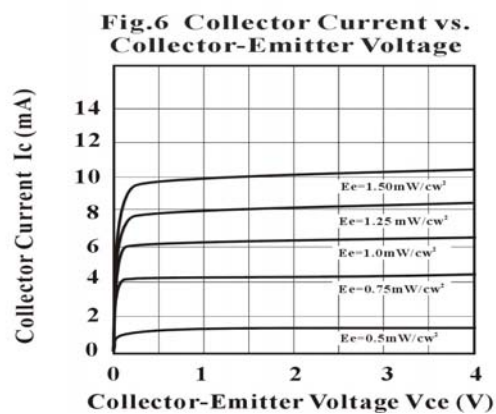
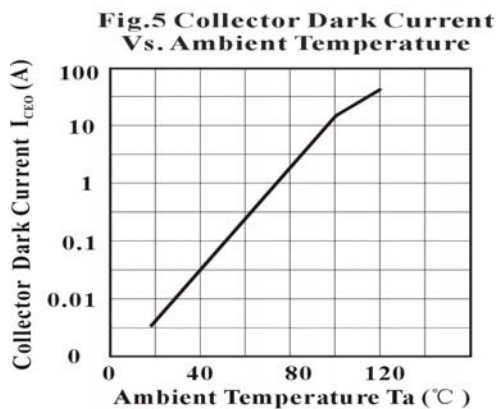
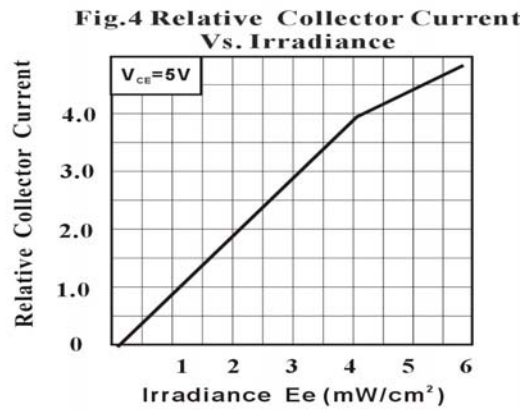
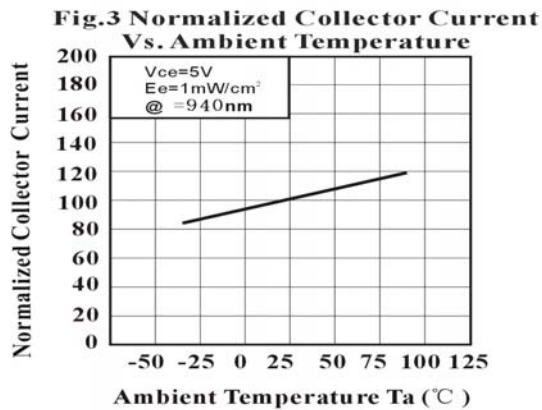
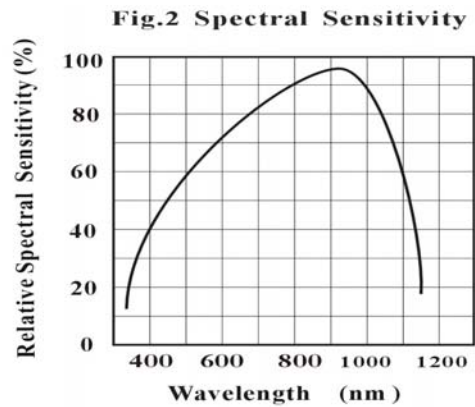
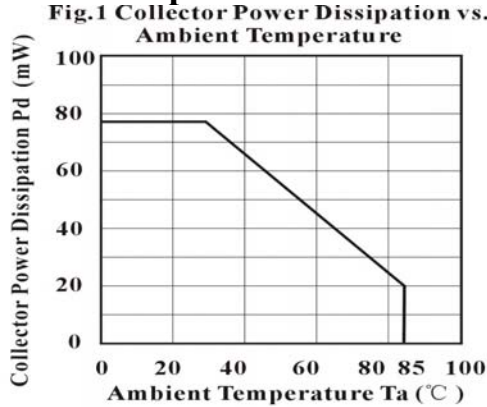

- ABSOLUTE MAXIMUM RATINGS: (Ta=25°C)
- OPERATING TEMPERATURE: -25°C TO +85°C
- LEAD SOLDERING TEMPERATURE: 260°C FOR 5 SECONDS

X-ON Electronics

Largest Supplier of Electrical and Electronic Components

Click to view similar products for [Ambient Light Sensors](#) category:

Click to view products by [Jing Chuang](#) manufacturer:

Other Similar products are found below :

[IS31SE5000-UTLS2-TR](#) [EAALSDIC03RDLA0](#) [LTR-F216A](#) [0805-PTSM D021](#) [TMD27721](#) [VEML7700-TT](#) [ALS-PT19-315C/L177/TR8](#)
[BH1680FVC-TR](#) [AS7261-BLGT](#) [180997-0006](#) [OPT3001IDNPRQ1](#) [OPT3007YMFT](#) [AS7263-BLGT](#) [APS3227SP1C-P22](#) [ALS-PDIC144-](#)
[6C/L378](#) [4681](#) [NSL 19M51](#) [NSL 4960](#) [AS7211-BLGM](#) [AS7211-BLGT](#) [AS7220-BLGM](#) [AS7221-BLGM](#) [AS7261N-BLGM](#) [AS7263-BLGM](#)
[AS72652-BLGM](#) [AS72652-BLGT](#) [AS7341-DLGM](#) [AS7341-DLGT](#) [TMD27253M](#) [TMD27553M](#) [TMD37024VCM](#) [TMD37193M](#)
[TMD37253M](#) [TSL25403M](#) [TSL27403M](#) [AS72653-BLGT](#) [APDS-9007-020](#) [APDS-9250](#) [APDS-9306-065](#) [LTR-507ALS-WA](#) [DY-FPD204-](#)
[6B/L3](#) [DY-FPD333-3B/L3](#) [DY-FPD333B-A5](#) [DY-FPD4134C-A3](#) [DY-PD204-6B](#) [DY-PD234-6B](#) [DY-PD333B-A5](#) [DY-PD673B-A2](#) [ALS-](#)
[PDIC15-21C/L230/TR8](#) [ALS-PDIC15-21B/TR8](#)