



Surface Mount Superfast Recovery Rectifier

Reverse Voltage – 50 to 600 V

Forward Current – 3 A

FEATURES

- For surface mounted applications
- Low profile package
- Glass Passivated Chip Junction
- Superfast reverse recovery time
- Lead free in comply with EU RoHS 2011/65/EU directives

MECHANICAL DATA

- Case: SMAF
- Terminals: Solderable per MIL-STD-750, Method 2026
- Approx. Weight: 27mg / 0.00095oz

PINNING

PIN	DESCRIPTION
1	Cathode
2	Anode

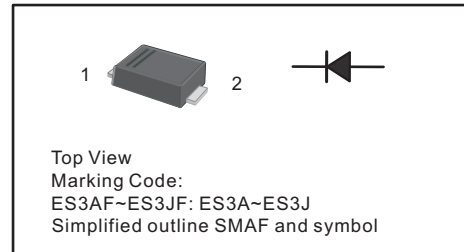

Absolute Maximum Ratings and Characteristics

Ratings at 25 °C ambient temperature unless otherwise specified. Single phase, half wave, 60 Hz, resistive or inductive load. For capacitive load, derate current by 20%.

Parameter	Symbols	ES3AF	ES3BF	ES3CF	ES3DF	ES3EF	ES3GF	ES3JF	Units
Maximum Repetitive Peak Reverse Voltage	V_{RRM}	50	100	150	200	300	400	600	V
Maximum RMS voltage	V_{RMS}	35	70	105	140	210	280	420	V
Maximum DC Blocking Voltage	V_{DC}	50	100	150	200	300	400	600	V
Maximum Average Forward Rectified Current at $T_c = 125\text{ °C}$	$I_{F(AV)}$	3							A
Peak Forward Surge Current 8.3 ms Single Half Sine Wave Superimposed on Rated Load	I_{FSM}	80							A
Maximum Forward Voltage at 3 A	V_F	1			1.25		1.68		V
Maximum DC Reverse Current at Rated DC Blocking Voltage $T_a = 25\text{ °C}$ $T_a = 125\text{ °C}$	I_R	5 100							μA
Typical Junction Capacitance at $V_R = 4\text{V}$, $f = 1\text{MHz}$	C_j	40							pF
Maximum Reverse Recovery Time ⁽¹⁾	t_{rr}	35							ns
Typical Thermal Resistance ⁽²⁾	$R_{\theta JA}$ $R_{\theta JC}$	50 16							$^{\circ}\text{C/W}$
Operating and Storage Temperature Range	T_j, T_{stg}	-55 ~ +150							$^{\circ}\text{C}$

(1) Measured with $I_F = 0.5\text{ A}$, $I_R = 1\text{ A}$, $I_{rr} = 0.25\text{ A}$.

(2) P.C.B. mounted with 2.0" X 2.0" (5 X 5 cm) copper pad areas.



Fig.1 Reverse Recovery Time Characteristic And Test Circuit Diagram

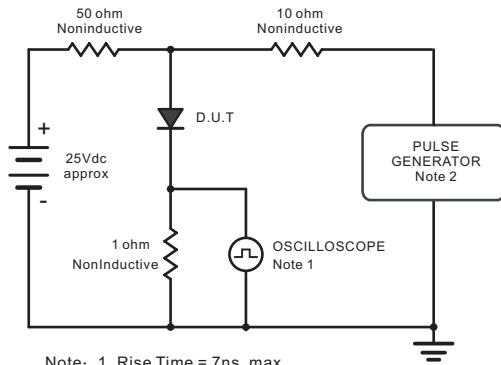

Note: 1. Rise Time = 7ns, max.
Input Impedance = 1megohm, 22pF.
2. Rises Time = 10ns, max.
Source Impedance = 50 ohms.



Fig.2 Maximum Average Forward Current Rating

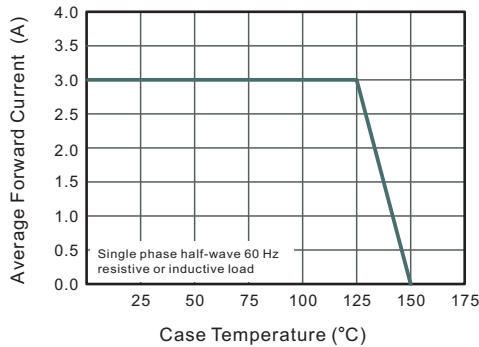

Fig.3 Typical Reverse Characteristics

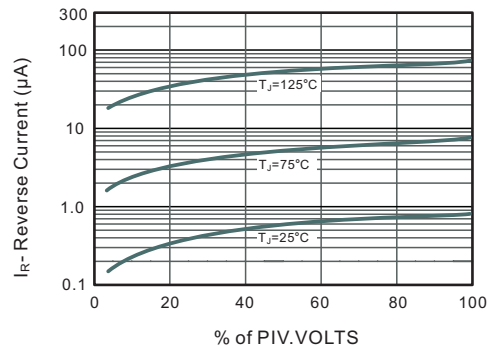

Fig.4 Typical Forward Characteristics

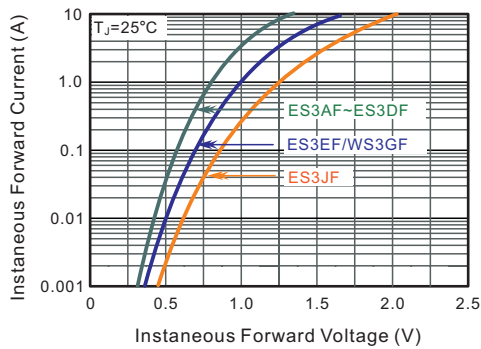

Fig.5 Typical Junction Capacitance

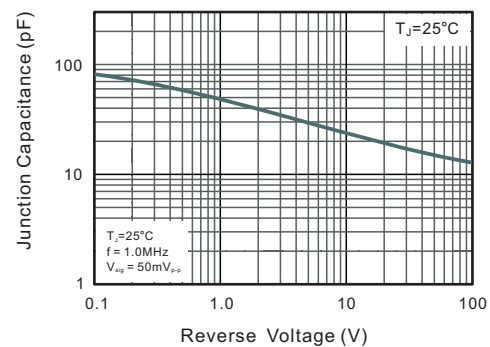
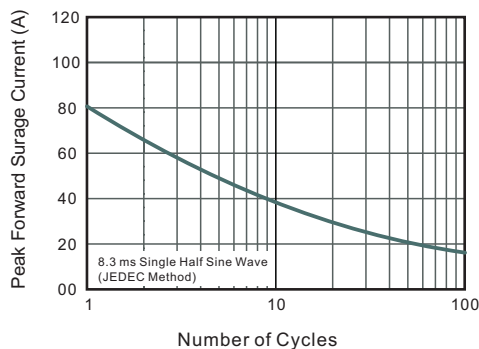

Fig.6 Maximum Non-Repetitive Peak Forward Surge Current





PACKAGE OUTLINE

Plastic surface mounted package; 2 leads

SMAF



The recommended mounting pad size

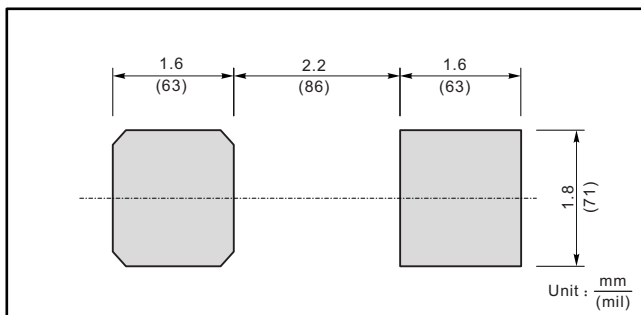

Marking

Type number	Marking code
ES3AF	ES3A
ES3BF	ES3B
ES3CF	ES3C
ES3DF	ES3D
ES3EF	ES3E
ES3GF	ES3G
ES3JF	ES3J

X-ON Electronics

Largest Supplier of Electrical and Electronic Components

Click to view similar products for [Rectifiers](#) category:

Click to view products by [Jingdao](#) manufacturer:

Other Similar products are found below :

[D91A](#) [DA24F4100L](#) [DD89N1600K-A](#) [DD89N16K-K](#) [RL252-TP](#) [DLA11C-TR-E](#) [DSA17G](#) [1N4005-TR](#) [BAV199-TP](#) [UFS120Je3/TR13](#)
[JANS1N6640US](#) [VS-80-1293](#) [DD89N16K](#) [DD89N16K-A](#) [481235F](#) [DSP10G-TR-E](#) [067907F](#) [MS306](#) [ND104N08K](#) [SPA2003-B-D-A01](#) [VS-](#)
[80-6193](#) [VS-66-9903](#) [VGF0136AB](#) [US2JFL-TP](#) [UFS105Je3/TR13](#) [A1N5404G-G](#) [ACGRA4007-HF](#) [ACGRB207-HF](#) [RF301B2STL](#)
[RF501B2STL](#) [UES1306](#) [UES1302](#) [BAV199E6433HTMA1](#) [ACGRC307-HF](#) [ACEFC304-HF](#) [JANTXV1N5660A](#) [UES1106](#) [GS2K-LTP](#)
[D126A45C](#) [D251N08B](#) [SCHJ22.5K](#) [SM100](#) [SCPA2](#) [SCH10000](#) [SDHD5K](#) [STTH20P035FP](#) [VS-8EWS12S-M3](#) [VS-12FL100S10](#)
[ACGRA4001-HF](#) [MUR420GP-TP](#)