

**Surface Mount Superfast Recovery Rectifier**  
Reverse Voltage – 50 to 600 V  
Forward Current –3 A

## FEATURES

- For surface mounted applications
- Low profile package
- Glass Passivated Chip Junction
- Superfast reverse recovery time
- Lead free in comply with EU RoHS 2011/65/EU directives

## MECHANICAL DATA

- Case : SMC
- Terminals: Solderable per MIL-STD-750, Method 2026
- Approx. Weight : 0.22g / 0.0077oz

## PINNING

PIN	DESCRIPTION
1	Cathode
2	Anode

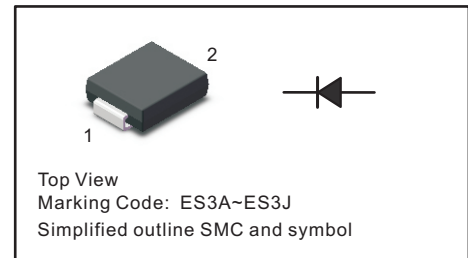

## Absolute Maximum Ratings and Characteristics

Ratings at 25 °C ambient temperature unless otherwise specified. Single phase, half wave, 60 Hz, resistive or inductive load. For capacitive load, derate current by 20%.

Parameter	Symbols	ES3AC	ES3BC	ES3CC	ES3DC	ES3EC	ES3GC	ES3JC	Units
Maximum Repetitive Peak Reverse Voltage	$V_{RRM}$	50	100	150	200	300	400	600	V
Maximum RMS voltage	$V_{RMS}$	35	70	105	140	210	280	420	V
Maximum DC Blocking Voltage	$V_{DC}$	50	100	150	200	300	400	600	V
Maximum Average Forward Rectified Current at $T_c = 125\text{ }^\circ\text{C}$	$I_{F(AV)}$	3							A
Peak Forward Surge Current 8.3 ms Single Half Sine Wave Superimposed on Rated Load	$I_{FSM}$	90							A
Maximum Forward Voltage at 3 A	$V_F$	1				1.25		1.68	V
Maximum DC Reverse Current at Rated DC Blocking Voltage $T_a = 25\text{ }^\circ\text{C}$ $T_a = 125\text{ }^\circ\text{C}$	$I_R$	5 100							$\mu\text{A}$
Typical Junction Capacitance at $V_R=4\text{V}$ , $f=1\text{MHz}$	$C_j$	40							pF
Maximum Reverse Recovery Time <sup>(1)</sup>	$t_{rr}$	35							ns
Typical Thermal Resistance <sup>(2)</sup>	$R_{\theta JA}$ $R_{\theta JC}$	40 16							$^\circ\text{C/W}$
Operating and Storage Temperature Range	$T_j, T_{stg}$	-55 ~ +150							$^\circ\text{C}$

(1) Measured with  $I_F = 0.5\text{ A}$ ,  $I_R = 1\text{ A}$ ,  $I_{rr} = 0.25\text{ A}$ .

(2) P.C.B. mounted with 2.0" X 2.0" (5 X 5 cm) copper pad areas.



Fig.1 Reverse Recovery Time Characteristic And Test Circuit Diagram

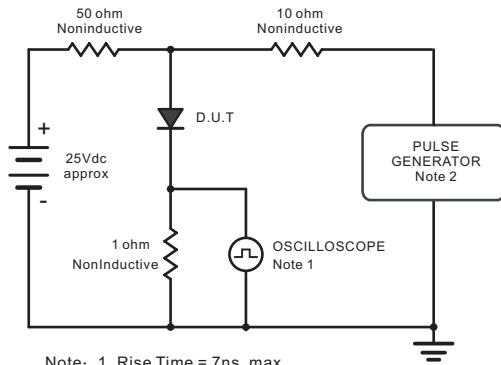

Note: 1. Rise Time = 7ns, max.  
Input Impedance = 1megohm, 22pF.  
2. Rise Time = 10ns, max.  
Source Impedance = 50 ohms.



Fig.2 Maximum Average Forward Current Rating

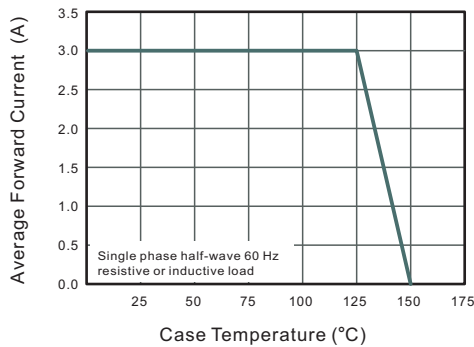

Fig.3 Typical Reverse Characteristics

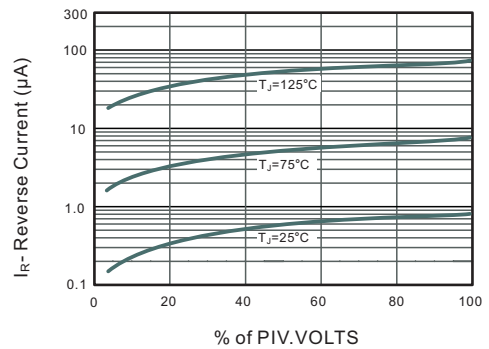

Fig.4 Typical Forward Characteristics

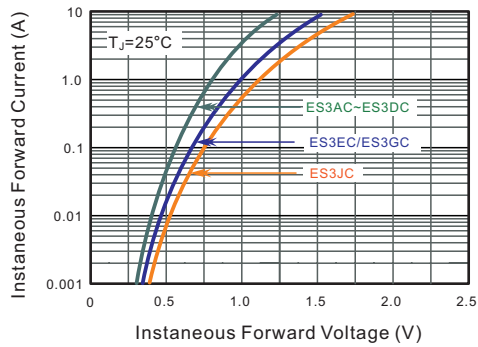

Fig.5 Typical Junction Capacitance

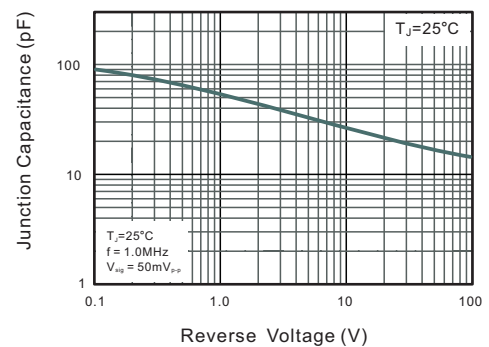
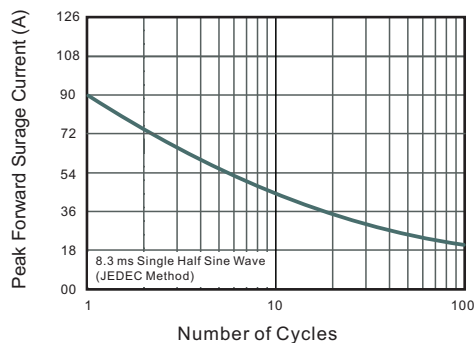

Fig.6 Maximum Non-Repetitive Peak Forward Surge Current





**PACKAGE OUTLINE**

Plastic surface mounted package; 2 leads

SMC



**The recommended mounting pad size**



**Marking**

Type number	Marking code
ES3AC	ES3A
ES3BC	ES3B
ES3CC	ES3C
ES3DC	ES3D
ES3EC	ES3E
ES3GC	ES3G
ES3JC	ES3J

## X-ON Electronics

Largest Supplier of Electrical and Electronic Components

*Click to view similar products for [Rectifiers](#) category:*

*Click to view products by [Jingdao](#) manufacturer:*

Other Similar products are found below :

[70HFR40](#) [FR105 R0](#) [RL252-TP](#) [150KR30A](#) [1N5397](#) [1N4002G](#) [1N4005-TR](#) [UFS120Je3/TR13](#) [JANS1N6640US](#) [481235F](#)  
[RRE02VS6SGTR](#) [067907F](#) [MS306](#) [70HF40](#) [T110HF60](#) [T85HFL60S02](#) [US2JFL-TP](#) [A1N5404G-G](#) [CRS04\(T5L,TEMQ\)](#)  
[CRS12\(T5L,TEMQ\)](#) [ACGRB207-HF](#) [CLH07\(TE16L,Q\)](#) [CLH03\(TE16L,Q\)](#) [ACGRC307-HF](#) [ACEFC304-HF](#) [NTE6356](#) [NTE6359](#) [85HFR60](#)  
[40HFR60](#) [70HF120](#) [85HFR80](#) [D126A45C](#) [SCF7500](#) [D251N08B](#) [SCHJ22.5K](#) [SM100](#) [SCPA2](#) [SDHD5K](#) [VS-12FL100S10](#) [ACGRA4001-](#)  
[HF](#) [ACURA107-HF](#) [D1821SH45T PR](#) [D1251S45T](#) [NTE6358](#) [NTE5850](#) [NTE5819](#) [NTE5837](#) [NTE5892](#) [NTE5900](#) [NTE5911](#)