



SCHOTTKY BARRIER RECTIFIERS

Reverse Voltage - 40 to 200 V

Forward Current - 10 A

FEATURES

- High current capability
- Low forward voltage drop
- Low power loss, high efficiency
- High surge capability
- High temperature soldering guaranteed
- Mounting position: any

TO-263W(D²PAK)

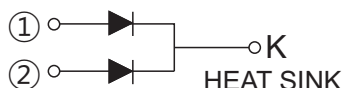
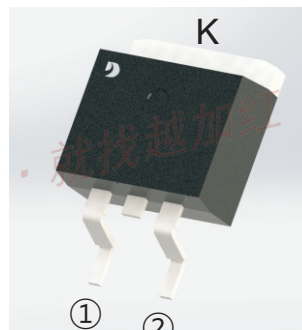

MAXIMUM RATINGS AND ELECTRICAL CHARACTERISTICS

Ratings at 25°C ambient temperature unless otherwise specified

CHARACTERISTICS	SYMBOL	MBR1040GT	MBR1045GT	MBR1060GT	MBR10100GT	MBR10150GT	MBR10200GT	Units
Maximum Recurrent Peak Reverse Voltage	V_{RRM}	40	45	60	100	150	200	V
Maximum RMS voltage	V_{RMS}	28	32	42	70	105	140	V
Maximum DC Blocking Voltage	V_{DC}	40	45	60	100	150	200	V
Maximum Average Forward Rectified Current per diode per device	$I_{F(AV)}$	5 10						A
Peak Forward Surge Current, 8.3ms Single Half Sine-wave Superimposed on Rated Load (JEDEC method) per diode	I_{FSM}	100						A
Max Instantaneous Forward Voltage at 5 A DC Per leg	V_F	0.70		0.75	0.85	0.90	0.92	V
Maximum DC Reverse Current at Rated DC Reverse Voltage	I_R	0.1 20			0.05 20			mA
Typical Junction Capacitance ⁽¹⁾	C_j	500			300			pF
Typical Thermal Resistance ⁽²⁾	$R_{\theta JA}$	45						°C/W
Operating Junction Temperature Range	T_j	-55 ~ +150				-55 ~ +175		°C
Storage Temperature Range	T_{stg}	-55 ~ +150				-55 ~ +175		°C

(1) Measured at 1 MHz and applied reverse voltage of 4 V D.C

(2) P.C.B. mounted with 10cmX10cmX1mm copper pad areas.



Fig.1 TYPICAL FORWARD CURRENT DERATING CURVE

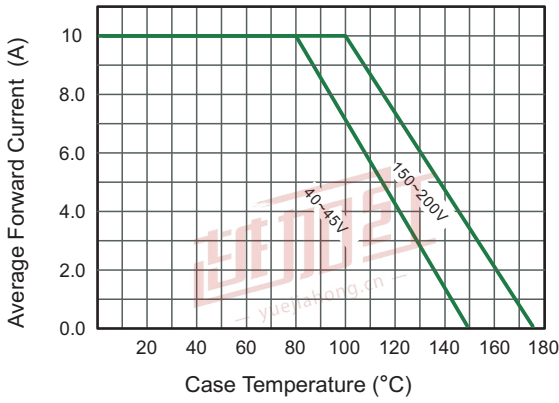

Fig.2 Typical Reverse Characteristics

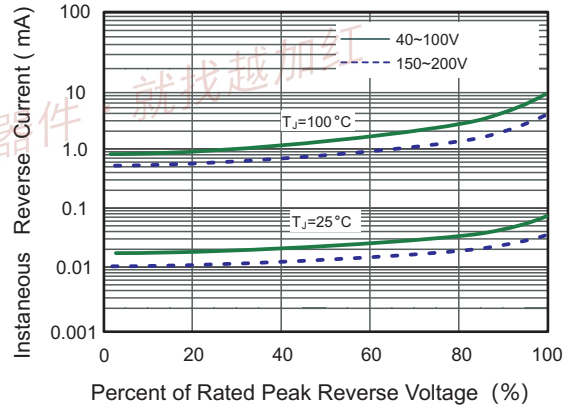

Fig.3 Typical Forward Characteristic(per leg)

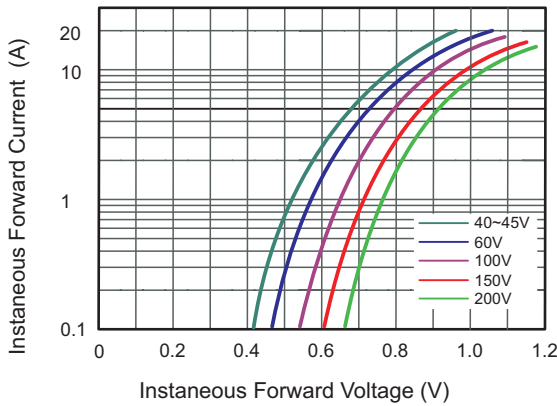

Fig.4 Typical Junction Capacitance

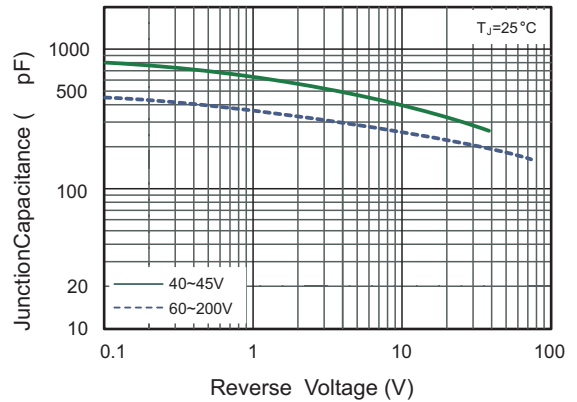

Fig.5 Maximum Non-Repetitive Peak Forward Surge Current

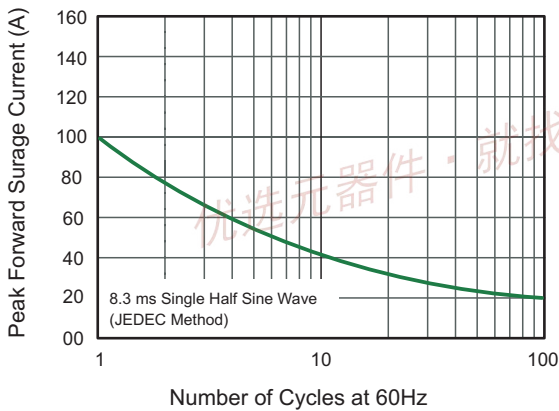
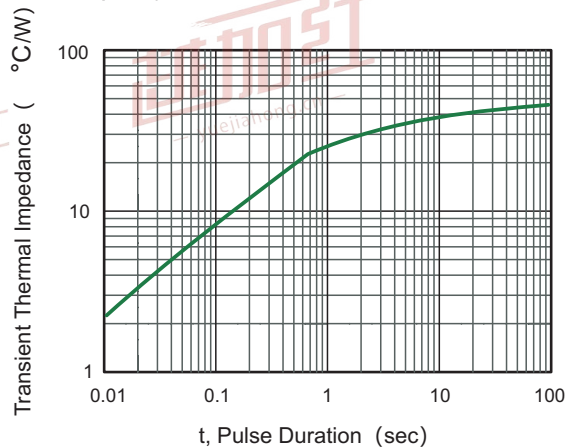
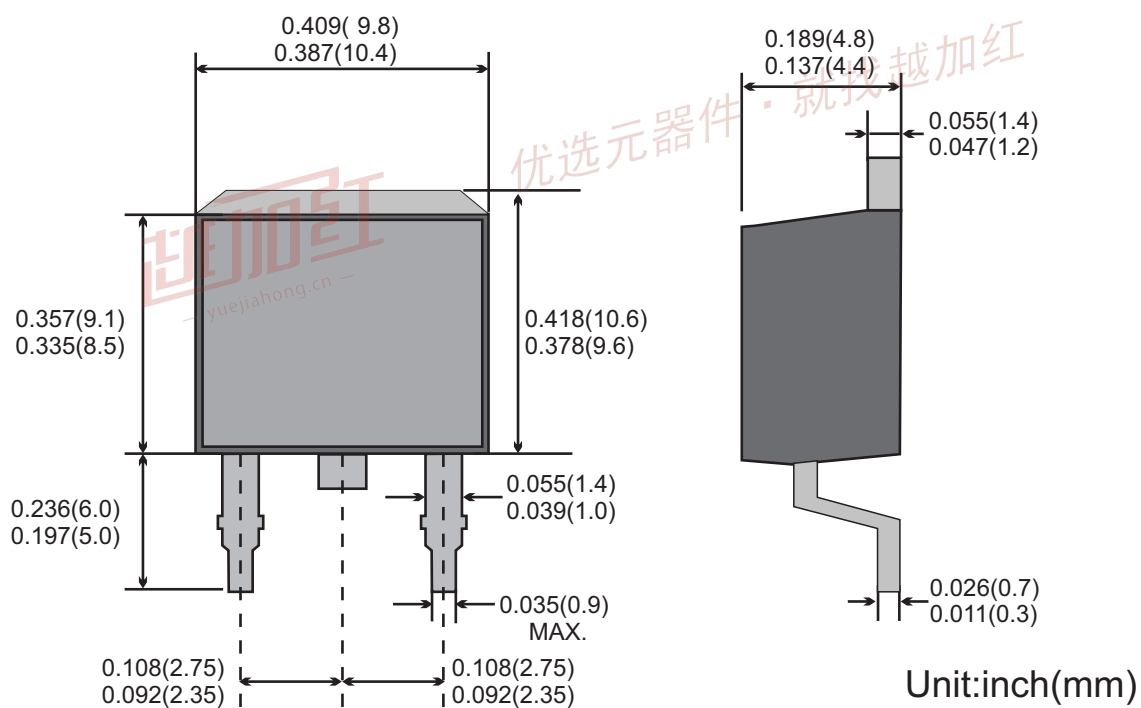

Fig.6- Typical Transient Thermal Impedance





TO-263W(D-P²AK) Package Outline Dimensions



MARKING DIAGRAM

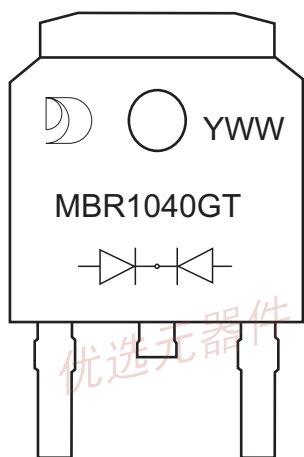

YWW: Date Code
Y: Years(0~9)
WW: Week
MBR1040GT: Product name
(NOTE: The weekly code is based on the actual number of weeks in the calendar year.)



Important Notice and Disclaimer

Jingdao Microelectronics reserves the right to make changes to this document and its products and specifications at any time without notice. Customers should obtain and confirm the latest product information and specifications before final design, purchase or use.

Jingdao Microelectronics makes no warranty, representation or guarantee regarding the suitability of its products for any particular purpose, not does Jingdao Microelectronics assume any liability for application assistance or customer product design.

Jingdao Microelectronics does not warrant or accept any liability with products which are purchased or used for any unintended or unauthorized application.

No license is granted by implication or otherwise under any intellectual property rights of Jingdao Microelectronics.

Jingdao Microelectronics products are not authorized for use as critical components in life support devices or systems without express written approval of Jingdao Microelectronics.

优选元器件 · 就找越加红

越加红
— yuejiahong.cn —

X-ON Electronics

Largest Supplier of Electrical and Electronic Components

Click to view similar products for [Schottky Diodes & Rectifiers](#) category:

Click to view products by [Jingdao](#) manufacturer:

Other Similar products are found below :

[MA4E2039](#) [MA4E2508M-1112](#) [MBR1545CT](#) [MMBD301M3T5G](#) [RB160M-50TR](#) [D83C](#) [BAS16E6433HTMA1](#) [BAT 54-02LRH E6327](#)
[NRVBAF360T3G](#) [NSR05F40QNXT5G](#) [NTE555](#) [JANS1N6640](#) [SK310-T](#) [SS3003CH-TL-E](#) [GA01SHT18](#) [CRS10I30A\(TE85L,QM](#)
[MA4E2501L-1290](#) [MBRA140TRPBF](#) [MBRB30H30CT-1G](#) [BAT 15-04R E6152](#) [JANTX1N5712-1](#) [DMJ3940-000](#) [SB007-03C-TB-E](#)
[SK33B-TP](#) [NRVBB20100CTT4G](#) [NRVBM120LT1G](#) [NTSB30U100CT-1G](#) [VS-6CWQ10FNHM3](#) [CRG04\(T5L,TEMQ\)](#) [ACDBA1100LR-HF](#)
[ACDBA1200-HF](#) [ACDBA240-HF](#) [ACDBA3100-HF](#) [CDBQC0530L-HF](#) [CDBQC0240LR-HF](#) [ACDBA260LR-HF](#) [ACDBA1100-HF](#)
[MA4E2502L-1246](#) [10BQ015-M3/5BT](#) [NRVBM120ET1G](#) [CRS08TE85LQM](#) [PMAD1108-LF](#) [B120Q-13-F](#) [1N5819T-G](#) [B0530WSQ-7-F](#)
[PDS1040Q-13](#) [B160BQ-13-F](#) [SDM05U20CSP-7](#) [B140S1F-7](#) [HSM560Je3/TR13](#)