



Surface Mount General Purpose Silicon Rectifiers

Reverse Voltage - 50 to 1000 V

Forward Current - 3 A

FEATURES

- For surface mounted applications
- Low profile package
- Glass Passivated Chip Junction
- Easy to pick and place
- Lead free in comply with EU RoHS 2011/65/EU directives

MECHANICAL DATA

- Case: SMC
- Terminals: Solderable per MIL-STD-750, Method 2026
- Approx. Weight: 0.22g / 0.0077oz

PINNING

PIN	DESCRIPTION
1	Cathode
2	Anode

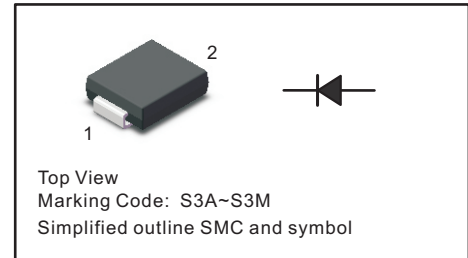

Maximum Ratings and Electrical characteristics

Ratings at 25 °C ambient temperature unless otherwise specified.

Single phase half-wave 60 Hz, resistive or inductive load, for capacitive load current derate by 20 %.

Parameter	Symbols	S3AC	S3BC	S3DC	S3GC	S3JC	S3KC	S3MC	Units
Maximum Repetitive Peak Reverse Voltage	V_{RRM}	50	100	200	400	600	800	1000	V
Maximum RMS voltage	V_{RMS}	35	70	140	280	420	560	700	V
Maximum DC Blocking Voltage	V_{DC}	50	100	200	400	600	800	1000	V
Maximum Average Forward Rectified Current	$I_{F(AV)}$	3							A
Peak Forward Surge Current 8.3 ms Single Half Sine Wave Superimposed on Rated Load	I_{FSM}	90							A
Maximum Instantaneous Forward Voltage at 3 A	V_F	1.0							V
Maximum DC Reverse Current at Rated DC Blocking Voltage $T_a = 25\text{ }^\circ\text{C}$ $T_a = 125\text{ }^\circ\text{C}$	I_R	5 100							μA
Typical Junction Capacitance ⁽¹⁾	C_j	40							pF
Typical Thermal Resistance ⁽²⁾	$R_{\theta JA}$ $R_{\theta JC}$	40 16							$^\circ\text{C/W}$
Operating and Storage Temperature Range	T_j, T_{stg}	-55 ~ +150							$^\circ\text{C}$

(1) Measured at 1 MHz and applied reverse voltage of 4 V D.C

(2) P.C.B. mounted with 2.0" X 2.0" (5 X 5 cm) copper pad areas.



Fig.1 Forward Current Derating Curve

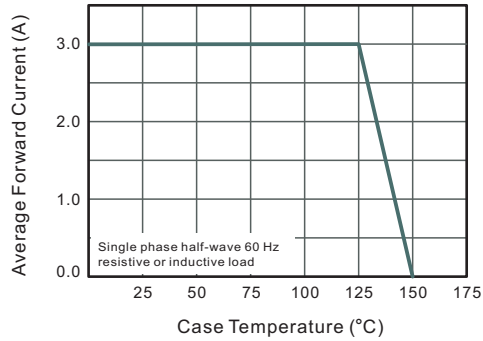

Fig.2 Typical Reverse Characteristics

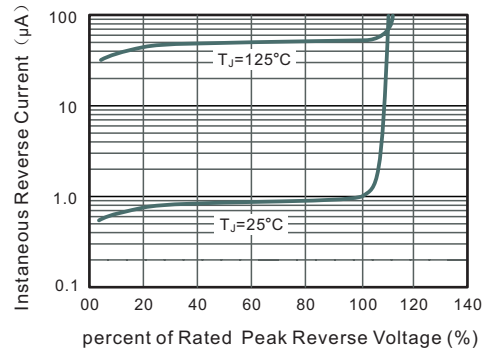

Fig.3 Typical Forward Characteristic

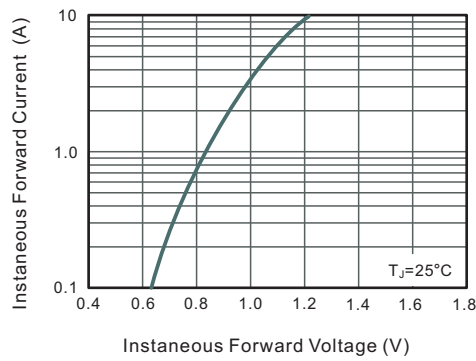

Fig.4 Typical Junction Capacitance

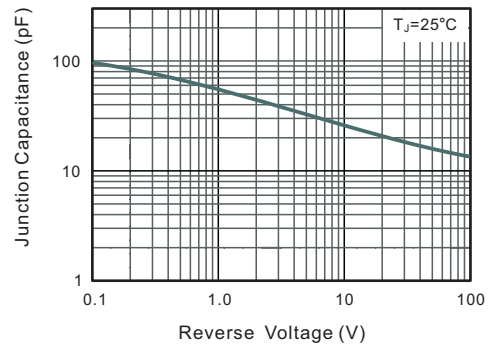
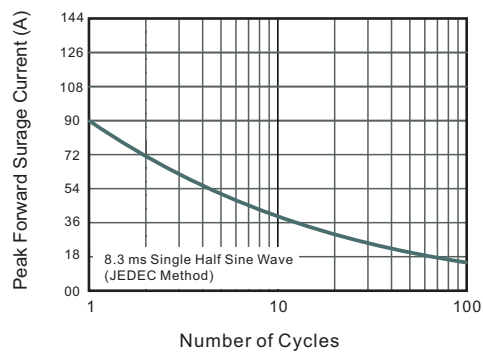

Fig.6 Maximum Non-Repetitive Peak Forward Surge Current





PACKAGE OUTLINE

Plastic surface mounted package; 2 leads

SMC

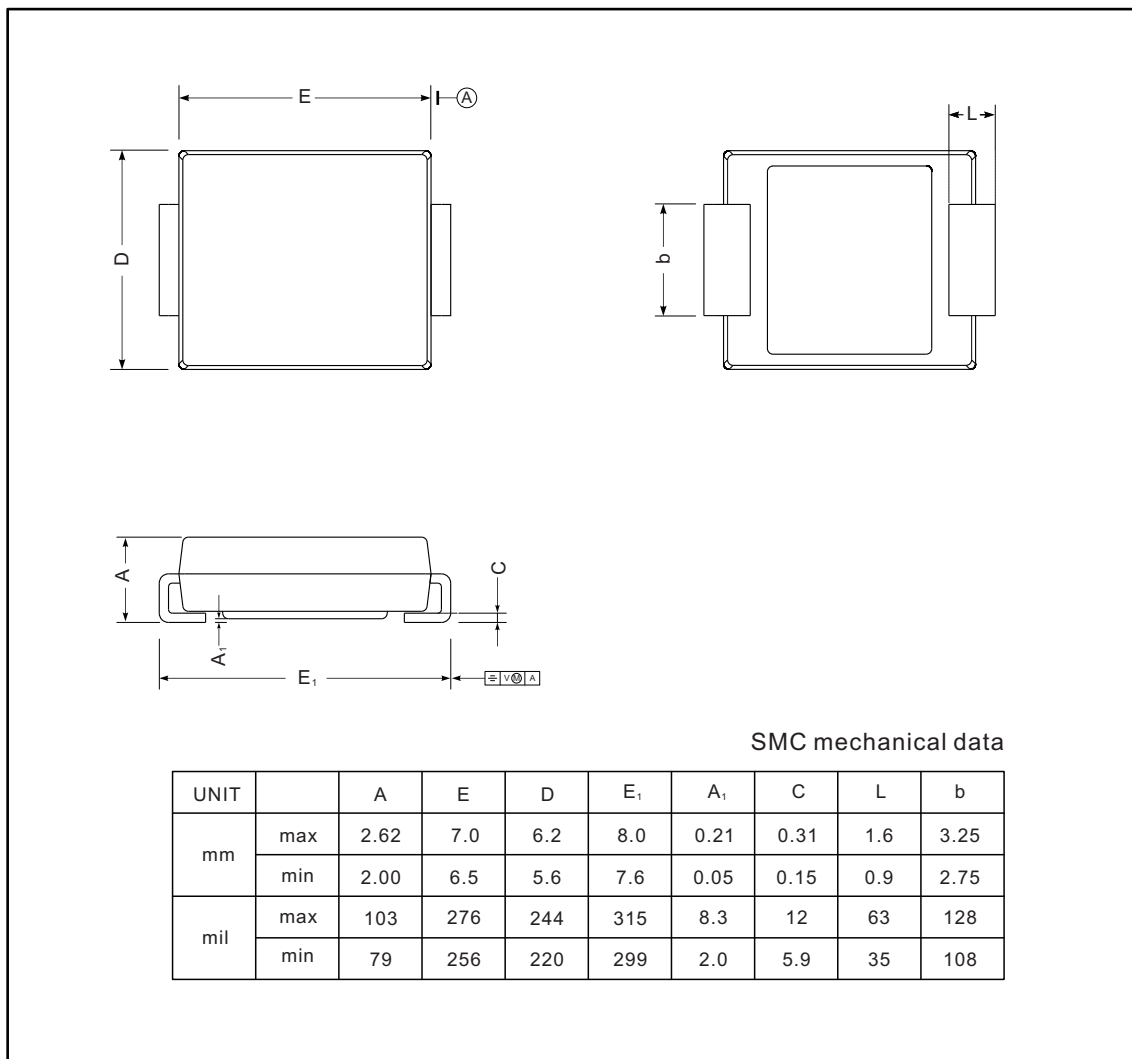

The recommended mounting pad size



Marking

Type number	Marking code
S3AC	S3A
S3BC	S3B
S3DC	S3D
S3GC	S3G
S3JC	S3J
S3KC	S3K
S3MC	S3M

X-ON Electronics

Largest Supplier of Electrical and Electronic Components

Click to view similar products for [Diodes - General Purpose, Power, Switching category](#):

Click to view products by [Jingdao manufacturer](#):

Other Similar products are found below :

[MMBD3004S-13-F](#) [RD0306T-H](#) [DSE010-TR-E](#) [BAV17-TR](#) [BAV19-TR](#) [1N3611](#) [NTE156A](#) [NTE574](#) [NTE6244](#) [1SS181-TP](#) [1SS193,LF](#)
[1SS400CST2RA](#) [SDAA13](#) [SHN2D02FUTW1T1G](#) [LS4151GS08](#) [1N4449](#) [1N456A](#) [1N4934-E3/73](#) [1N914B](#) [1N914BTR](#) [1SS226-TP](#)
[RFUH20TB3S](#) [D291S45T](#) [BAV300-TR](#) [BAW56DWQ-7-F](#) [BAW75-TAP](#) [MM230L-CAA](#) [IDW40E65D1](#) [JAN1N3600](#) [LL4151-GS18](#)
[053684A](#) [SMMSD4148T3G](#) [707803H](#) [NSVDAN222T1G](#) [CDSZC01100-HF](#) [LL4150-M-08](#) [BAV199E6433HTMA1](#) [BAS28-7](#)
[BAW56HDW-13](#) [BAS28 TR](#) [VS-HFA04SD60STR-M3](#) [NSVM1MA152WKT1G](#) [RGP30D-E3/73](#) [BAV99TQ-13-F](#) [BAS21DWA-7](#) [NTE6250](#)
[NTE582-4](#) [NTE582-6](#) [MMDB30-E28X](#) [VS-HFA04SD60SL-M3](#)