

Surface mount transient voltage suppressor power 600 watts

Stand-Off Voltage : 5.0V~440V

FEATURES

- For surface mounted applications in order to optimize board space.
- Low profile package
- Glass passivated junction
- Low inductance
- Plastic package has Underwriters Laboratory Flammability

MECHANICAL DATA

- Case: SMB
- Terminals: Solderable per MIL-STD-750, Method 2026
- Approx. Weight: 0.055g / 0.002oz

PINNING

| PIN | DESCRIPTION |
|-----|-------------|
| 1 | Cathode |
| 2 | Anode |

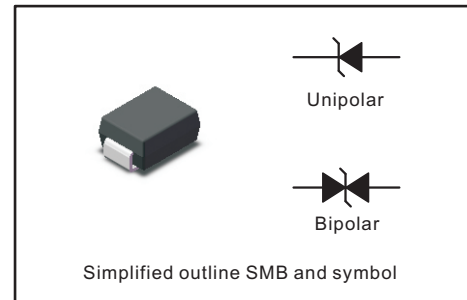

Maximum Ratings and Electrical characteristics

Ratings at 25 °C ambient temperature unless otherwise specified.

| Parameter | Symbol | Value | Unit |
|--|--------------------------|----------------------|------|
| Peak Pulse Power Dissipation on 10/1000 s waveform (Note1,Note2, Fig.1). | P_{PPM} | 600 | W |
| Peak Forward Surge Current, 8.3ms Single Half Sine-Wave Superimposed on Rated Load, (JEDEC Method) (Note 3, Fig4). | I_{FSM} (UNI) | 100 | A |
| Peak Pulse Current on 10/1000 us waveform (Note 1, Fig 3) | I_{PPM} | see Table 1 | A |
| Typical Junction capacitance at VR=4V, f=1MHz | C_J | 390 | pF |
| ESD Voltage per IEC6100-4-2 Contact Air | V_{ESD1} V_{ESD2} | ± 30 ± 30 | kV |
| Typical Thermal Resistance Junction to Ambient(Note 2) | $R_{\theta JA}$ | 100 | °C/W |
| Operating Junction Temperature and Storage Temperature Range | T_j, T_{stg} | -65 ~ +150 | °C |

NOTES:

1. Non-repetitive current pulse, per Fig.3 and derated above $T_A = 25^\circ\text{C}$ per Fig. 2.
2. Mounted on 5 mm² (0.13mm thick) land areas.
3. Measured on 8.3ms, single half sine-wave or equivalent square wave, duty cycle=4 pulses per minute maximum.
4. Peak pulse power waveform is 10/1000μS.

| Type | | Reverse Stand-off Voltage | Breakdown Voltage | | Test Current | Maximum Reverse Leakage | Max. Clamp Voltage | Peak Pulse Current | Package | |
|---|------------|---------------------------|----------------------------------|------|----------------|----------------------------------|--------------------|----------------------|---------|----|
| | | | V _{BR} @ I _T | | | | | | SMB | |
| | | V _{RMW} | Min | Max | I _T | V _C @ I _{PP} | I _{PP} | Device Marking Ccode | UNI | BI |
| UNI | BI | V | V | V | mA | µA | V | A | UNI | BI |
| 600W Transient Voltage Suppresso | | | | | | | | | | |
| SMBJ5.0A | SMBJ5.0CA | 5 | 6.4 | 7 | 10 | 800 | 9.2 | 65.3 | KE | AE |
| SMBJ6.0A | SMBJ6.0CA | 6 | 6.67 | 7.37 | 10 | 800 | 10.3 | 58.3 | KG | AG |
| SMBJ6.5A | SMBJ6.5CA | 6.5 | 7.22 | 7.98 | 10 | 500 | 11.2 | 53.6 | KK | AK |
| SMBJ7.0A | SMBJ7.0CA | 7 | 7.78 | 8.6 | 10 | 200 | 12.0 | 50.0 | KM | AM |
| SMBJ7.5A | SMBJ7.5CA | 7.5 | 8.33 | 9.21 | 1 | 100 | 12.9 | 46.6 | KP | AP |
| SMBJ8.0A | SMBJ8.0CA | 8 | 8.89 | 9.83 | 1 | 50 | 13.6 | 44.2 | KR | AR |
| SMBJ8.5A | SMBJ8.5CA | 8.5 | 9.44 | 10.4 | 1 | 20 | 14.4 | 41.7 | KT | AT |
| SMBJ9.0A | SMBJ9.0CA | 9 | 10 | 11.1 | 1 | 10 | 15.4 | 39.0 | KV | AV |
| SMBJ10A | SMBJ10CA | 10 | 11.1 | 12.3 | 1 | 5 | 17.0 | 35.3 | KX | AX |
| SMBJ11A | SMBJ11CA | 11 | 12.2 | 13.5 | 1 | 1 | 18.2 | 33.0 | KZ | AZ |
| SMBJ12A | SMBJ12CA | 12 | 13.3 | 14.7 | 1 | 1 | 19.9 | 30.2 | LE | BE |
| SMBJ13A | SMBJ13CA | 13 | 14.4 | 15.9 | 1 | 1 | 21.5 | 28.0 | LG | BG |
| SMBJ14A | SMBJ14CA | 14 | 15.6 | 17.2 | 1 | 1 | 23.2 | 25.9 | LK | BK |
| SMBJ15A | SMBJ15CA | 15 | 16.7 | 18.5 | 1 | 1 | 24.4 | 24.6 | LM | BM |
| SMBJ16A | SMBJ16CA | 16 | 17.8 | 19.7 | 1 | 1 | 26.0 | 23.1 | LP | BP |
| SMBJ17A | SMBJ17CA | 17 | 18.9 | 20.9 | 1 | 1 | 27.6 | 21.8 | LR | BR |
| SMBJ18A | SMBJ18CA | 18 | 20 | 22.1 | 1 | 1 | 29.2 | 20.6 | LT | BT |
| SMBJ20A | SMBJ20CA | 20 | 22.2 | 24.5 | 1 | 1 | 32.4 | 18.6 | LV | BV |
| SMBJ22A | SMBJ22CA | 22 | 24.4 | 26.9 | 1 | 1 | 35.5 | 16.9 | LX | BX |
| SMBJ24A | SMBJ24CA | 24 | 26.7 | 29.5 | 1 | 1 | 38.9 | 15.5 | LZ | BZ |
| SMBJ26A | SMBJ26CA | 26 | 28.9 | 31.9 | 1 | 1 | 42.1 | 14.3 | ME | CE |
| SMBJ28A | SMBJ28CA | 28 | 31.1 | 34.4 | 1 | 1 | 45.4 | 13.3 | MG | CG |
| SMBJ30A | SMBJ30CA | 30 | 33.3 | 36.8 | 1 | 1 | 48.4 | 12.4 | MK | CK |
| SMBJ33A | SMBJ33CA | 33 | 36.7 | 40.6 | 1 | 1 | 53.3 | 11.3 | MM | CM |
| SMBJ36A | SMBJ36CA | 36 | 40 | 44.2 | 1 | 1 | 58.1 | 10.4 | MP | CP |
| SMBJ40A | SMBJ40CA | 40 | 44.4 | 49.1 | 1 | 1 | 64.5 | 9.3 | MR | CR |
| SMBJ43A | SMBJ43CA | 43 | 47.8 | 52.8 | 1 | 1 | 69.4 | 8.7 | MT | CT |
| SMBJ45A | SMBJ45CA | 45 | 50 | 55.3 | 1 | 1 | 72.7 | 8.3 | MV | CV |
| SMBJ48A | SMBJ48CA | 48 | 53.3 | 58.9 | 1 | 1 | 77.4 | 7.8 | MX | CX |
| SMBJ51A | SMBJ51CA | 51 | 56.7 | 62.7 | 1 | 1 | 82.4 | 7.3 | MZ | CZ |
| SMBJ54A | SMBJ54CA | 54 | 60 | 66.3 | 1 | 1 | 87.1 | 6.9 | NE | DE |
| SMBJ58A | SMBJ58CA | 58 | 64.4 | 71.2 | 1 | 1 | 93.6 | 6.5 | NG | DG |
| SMBJ60A | SMBJ60CA | 60 | 66.7 | 73.7 | 1 | 1 | 96.8 | 6.2 | NK | DK |
| SMBJ64A | SMBJ64CA | 64 | 71.1 | 78.6 | 1 | 1 | 103.0 | 5.9 | NM | DM |
| SMBJ70A | SMBJ70CA | 70 | 77.8 | 86 | 1 | 1 | 113.0 | 5.3 | NP | DP |
| SMBJ75A | SMBJ75CA | 75 | 83.3 | 92.1 | 1 | 1 | 121.0 | 5.0 | NR | DR |
| SMBJ78A | SMBJ78CA | 78 | 86.7 | 95.8 | 1 | 1 | 126.0 | 4.8 | NT | DT |
| SMBJ85A | SMBJ85CA | 85 | 94.4 | 104 | 1 | 1 | 137.0 | 4.4 | NV | DV |
| SMBJ90A | SMBJ90CA | 90 | 100 | 111 | 1 | 1 | 146.0 | 4.1 | NX | DX |
| SMBJ100A | SMBJ100CA | 100 | 111 | 123 | 1 | 1 | 162.0 | 3.7 | NZ | DZ |
| SMBJ110A | SMBJ110CA | 110 | 122 | 135 | 1 | 1 | 177.0 | 3.4 | PE | EE |
| SMBJ120A | SMBJ120CA | 120 | 133 | 147 | 1 | 1 | 193.0 | 3.1 | PG | EG |
| SMBJ130A | SMBJ130CA | 130 | 144 | 159 | 1 | 1 | 209.0 | 2.9 | PK | EK |
| SMBJ150A | SMBJ150CA | 150 | 167 | 185 | 1 | 1 | 243.0 | 2.5 | PM | EM |
| SMBJ160A | SMBJ160CA | 160 | 178 | 197 | 1 | 1 | 259.0 | 2.3 | PP | EP |
| SMBJ170A | SMBJ170CA | 170 | 189 | 209 | 1 | 1 | 275.0 | 2.2 | PR | ER |
| SMBJ180A | SMBJ180CA | 180 | 201 | 222 | 1 | 1 | 292.0 | 2.1 | PT | ET |
| SMBJ188A | SMBJ188CA | 188 | 209 | 231 | 1 | 1 | 304.0 | 2.0 | PB | EB |
| SMBJ200A | SMBJ200CA | 200 | 224 | 247 | 1 | 1 | 324.0 | 1.9 | PV | EV |
| SMBJ220A | SMBJ220CA | 220 | 246 | 272 | 1 | 1 | 356.0 | 1.7 | PX | EX |
| SMBJ250A | SMBJ250CA | 250 | 279 | 309 | 1 | 1 | 405.0 | 1.5 | PZ | EZ |
| SMBJ300A* | SMBJ300CA* | 300 | 335 | 371 | 1 | 1 | 486.0 | 1.3 | QE | FE |
| SMBJ350A* | SMBJ350CA* | 350 | 391 | 432 | 1 | 1 | 567.0 | 1.1 | QG | FG |
| SMBJ400A* | SMBJ400CA* | 400 | 447 | 494 | 1 | 1 | 648.0 | 0.9 | QK | FK |
| SMBJ440A* | SMBJ440CA* | 440 | 492 | 543 | 1 | 1 | 713.0 | 0.9 | QM | FM |



Fig.1 Peak Pulse Power Rating Curve

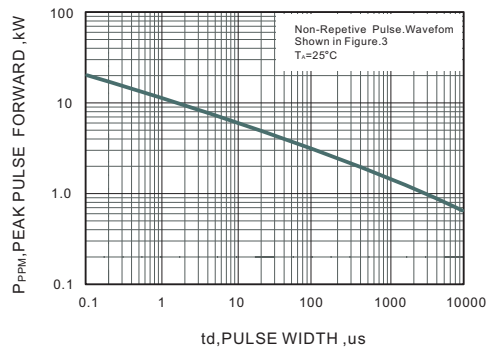

Fig.2 Forward Current Derating Curve

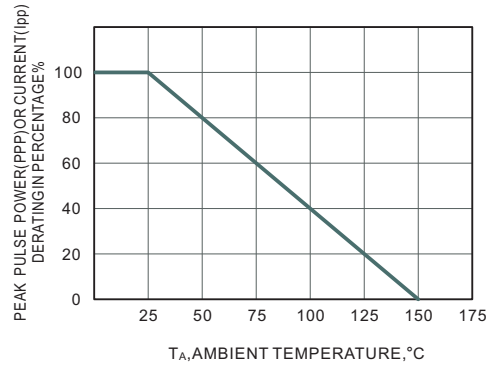

Fig.3 Pulse Waveform

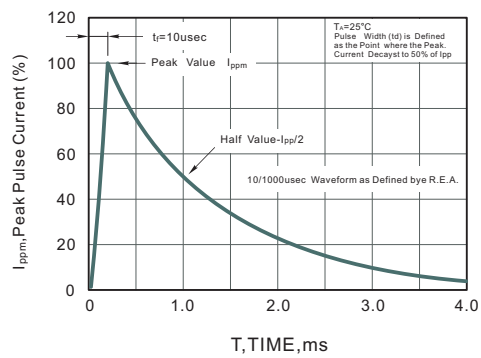
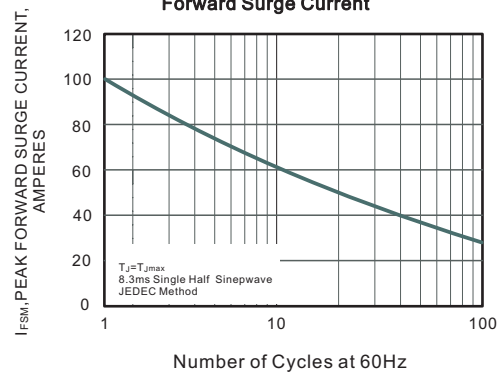

Fig.4 Maximum Non-Repetitive Peak Forward Surge Current





PACKAGE OUTLINE

Plastic surface mounted package; 2 leads

SMB

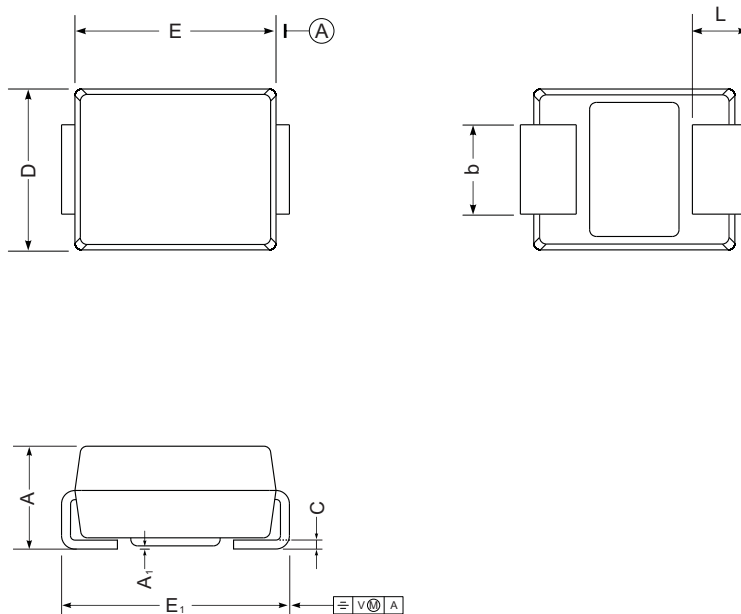

SMB mechanical data

| UNIT | | A | E | D | E ₁ | A ₁ | L | C | b |
|------|-----|------|------|------|----------------|----------------|-----|-------|------|
| mm | max | 2.44 | 4.70 | 3.94 | 5.59 | 0.20 | 1.5 | 0.305 | 2.11 |
| | min | 2.13 | 4.06 | 3.3 | 5.08 | 0.05 | 0.8 | 0.152 | 1.91 |
| mil | max | 96 | 185 | 155 | 220 | 7.9 | 59 | 12 | 83 |
| | min | 84 | 160 | 130 | 200 | 2.0 | 32 | 6 | 75 |

The recommended mounting pad size

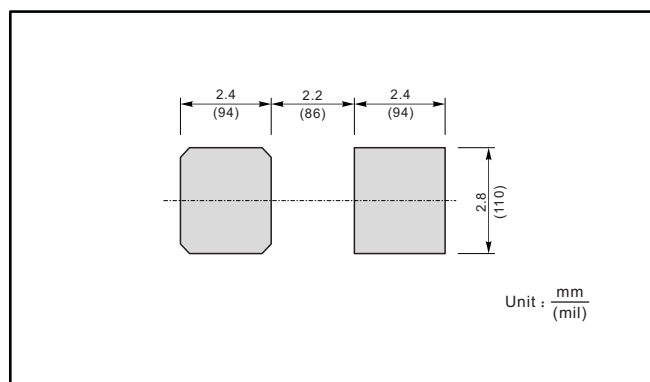

Unit: $\frac{\text{mm}}{\text{mil}}$

X-ON Electronics

Largest Supplier of Electrical and Electronic Components

Click to view similar products for [ESD Suppressors / TVS Diodes](#) category:

Click to view products by [Jingdao](#) manufacturer:

Other Similar products are found below :

[60KS200C](#) [D18V0L1B2LP-7B](#) [D5V0F4U5P5-7](#) [DESD5V0U1BB-7](#) [NTE4902](#) [P4KE27CA](#) [P6KE11CA](#) [P6KE39CA-TP](#) [P6KE8.2A](#)
[SA110CA](#) [SA60CA](#) [SA64CA](#) [SMBJ12CATR](#) [SMBJ33CATR](#) [SMBJ8.0A](#) [ESD101-B1-02ELS E6327](#) [ESD105-B1-02EL E6327](#) [ESD112-B1-02EL E6327](#) [ESD119B1W01005E6327XTSA1](#) [ESD5V0L1B02VH6327XTSA1](#) [ESD7451N2T5G](#) [19180-510](#) [CPDT-5V0USP-HF](#)
[3.0SMCJ33CA-F](#) [3.0SMCJ36A-F](#) [HSPC16701B02TP](#) [D3V3Q1B2DLP3-7](#) [D55V0M1B2WS-7](#) [DESD5V0U1BL-7B](#) [DRTR5V0U4SL-7](#)
[SCM1293A-04SO](#) [ESD200-B1-CSP0201 E6327](#) [SM12-7](#) [SMF8.0A-TP](#) [SMLJ45CA-TP](#) [CEN955 W/DATA](#) [82350120560](#) [VESD12A1A-](#)
[HD1-GS08](#) [CPDUR5V0R-HF](#) [CPDQC5V0U-HF](#) [CPDQC5V0USP-HF](#) [CPDQC5V0-HF](#) [D1213A-01LP4-7B](#) [D1213A-02WL-7](#)
[MMAD1108/TR13](#) [5KP100A](#) [5KP15A](#) [5KP18A](#) [5KP48A](#) [5KP90A](#)