



The SMC series is designed specifically to protect sensitive electronic equipment from voltage transients induced by lightning and other transient voltage events.

### FEATURES

- 1500W peak pulse power capability at 10/1000 $\mu$ s waveform
- For surface mounted applications to optimize board space
- Glass passivated chip junction
- Halogen free and RoHS compliant

### MECHANICAL DATA

- Case: SMC
- Terminals: Solderable per MIL-STD-750, Method 2026
- Approx. Weight: 0.22g (0.0077oz)

### PINNING

PIN	DESCRIPTION
1	Cathode
2	Anode

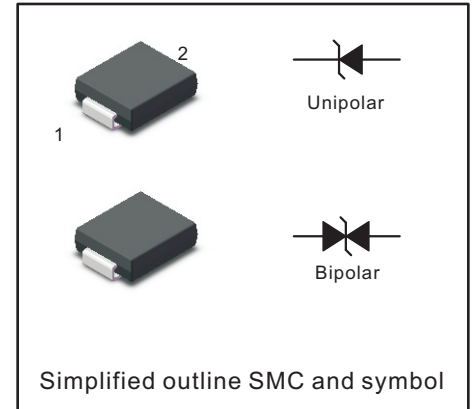

Parameter	Symbol	Value	Unit
Peak Pulse Power Dissipation on 10/1000 us waveform	$P_{PPM}$	600	W
Peak Forward Surge Current, 8.3ms Single Half Sine-Wave Superimposed on Rated Load (JEDEC Method)	$I_{FSM}$ (UNI)	100	A
Maximum instantaneous forward voltage at 100 A for unidirectional only	$V_F$	3.5	V
Peak Pulse Current on 10/1000 us waveform	$I_{PPM}$	See Next Table	A
Typical Thermal Resistance Junction to Ambient(Note 1)	$R_{\theta JA}$ $R_{\theta JL}$	75 15	$^{\circ}\text{C}/\text{W}$
Operating Junction Temperature and Storage Temperature Range	$T_j, T_{stg}$	-55 ~ +150	$^{\circ}\text{C}$

#### NOTES:

1. Mounted on 8 mm<sup>2</sup> (0.13mm thick) land areas.

**Characteristics at Ta = 25°C**

Type		Marking		Reverse Stand-off Voltage	Breakdown Voltage		Test Current	Max Clamping Voltage	Peak Pulse Current	Maximum Reverse Leakage
				V <sub>RMW</sub>	V <sub>BR</sub> @ I <sub>T</sub>		I <sub>T</sub>	V <sub>C</sub> @ I <sub>PP</sub>	I <sub>PP</sub>	I <sub>R</sub>
UNI	BI	UNI	BI	V	Min(V)	Max(V)	mA	V	A	µA
SMCJ5.0A-L	SMCJ5.0CA-L	GDE	BDE	5	6.4	7	10	9.2	65.3	800
SMCJ6.0A-L	SMCJ6.0CA-L	GDG	BDG	6	6.67	7.37	10	10.3	58.3	800
SMCJ6.5A-L	SMCJ6.5CA-L	GDK	BDK	6.5	7.22	7.98	10	11.2	53.6	500
SMCJ7.0A-L	SMCJ7.0CA-L	GDM	BDM	7	7.78	8.6	10	12	50.0	200
SMCJ7.5A-L	SMCJ7.5CA-L	GDP	BDP	7.5	8.33	9.21	1	12.9	46.6	100
SMCJ8.0A-L	SMCJ8.0CA-L	GDR	BDR	8	8.89	9.83	1	13.6	44.2	50
SMCJ8.5A-L	SMCJ8.5CA-L	GDT	BDT	8.5	9.44	10.4	1	14.4	41.7	20
SMCJ9.0A-L	SMCJ9.0CA-L	GDV	BDV	9	10	11.1	1	15.4	39.0	10
SMCJ10A-L	SMCJ10CA-L	GDX	BDX	10	11.1	12.3	1	17	35.3	5
SMCJ11A-L	SMCJ11CA-L	GDZ	BDZ	11	12.2	13.5	1	18.2	33.0	1
SMCJ12A-L	SMCJ12CA-L	GEE	BEE	12	13.3	14.7	1	19.9	30.2	1
SMCJ13A-L	SMCJ13CA-L	GEG	BEG	13	14.4	15.9	1	21.5	28.0	1
SMCJ14A-L	SMCJ14CA-L	GEK	BEK	14	15.6	17.2	1	23.2	25.9	1
SMCJ15A-L	SMCJ15CA-L	GEM	BEM	15	16.7	18.5	1	24.4	24.6	1
SMCJ16A-L	SMCJ16CA-L	GEP	BEP	16	17.8	19.7	1	26	23.1	1
SMCJ17A-L	SMCJ17CA-L	GER	BER	17	18.9	20.9	1	27.6	21.8	1
SMCJ18A-L	SMCJ18CA-L	GET	BET	18	20	22.1	1	29.2	20.6	1
SMCJ20A-L	SMCJ20CA-L	GEV	BEV	20	22.2	24.5	1	32.4	18.6	1
SMCJ22A-L	SMCJ22CA-L	GEX	BEX	22	24.4	26.9	1	35.5	16.9	1
SMCJ24A-L	SMCJ24CA-L	GEZ	BEZ	24	26.7	29.5	1	38.9	15.5	1
SMCJ26A-L	SMCJ26CA-L	GFE	BFE	26	28.9	31.9	1	42.1	14.3	1
SMCJ28A-L	SMCJ28CA-L	GFG	BFG	28	31.1	34.4	1	45.4	13.3	1
SMCJ30A-L	SMCJ30CA-L	GFK	BFK	30	33.3	36.8	1	48.4	12.4	1
SMCJ33A-L	SMCJ33CA-L	GFM	BFM	33	36.7	40.6	1	53.3	11.3	1
SMCJ36A-L	SMCJ36CA-L	GFP	BFP	36	40	44.2	1	58.1	10.4	1
SMCJ40A-L	SMCJ40CA-L	GFR	BFR	40	44.4	49.1	1	64.5	9.3	1
SMCJ43A-L	SMCJ43CA-L	GFT	BFT	43	47.8	52.8	1	69.4	8.7	1
SMCJ45A-L	SMCJ45CA-L	GFV	BFV	45	50	55.3	1	72.7	8.3	1
SMCJ48A-L	SMCJ48CA-L	GFX	BFX	48	53.3	58.9	1	77.4	7.8	1
SMCJ51A-L	SMCJ51CA-L	GFZ	BFZ	51	56.7	62.7	1	82.4	7.3	1
SMCJ54A-L	SMCJ54CA-L	GGE	BGE	54	60	66.3	1	87.1	6.9	1
SMCJ58A-L	SMCJ58CA-L	GGG	BGG	58	64.4	71.2	1	93.6	6.5	1
SMCJ60A-L	SMCJ60CA-L	GGK	BGK	60	66.7	73.7	1	96.8	6.2	1
SMCJ64A-L	SMCJ64CA-L	GGM	BGM	64	71.1	78.6	1	103	5.9	1
SMCJ70A-L	SMCJ70CA-L	GGP	BGP	70	77.8	86	1	113	5.3	1
SMCJ75A-L	SMCJ75CA-L	GGR	BGR	75	83.3	92.1	1	121	5.0	1
SMCJ78A-L	SMCJ78CA-L	GGT	BGT	78	86.7	95.8	1	126	4.8	1
SMCJ85A-L	SMCJ85CA-L	GGV	BGV	85	94.4	104	1	137	4.4	1
SMCJ90A-L	SMCJ90CA-L	GGX	BGX	90	100	111	1	146	4.1	1
SMCJ100A-L	SMCJ100CA-L	GGZ	BGZ	100	111	123	1	162	3.7	1
SMCJ110A-L	SMCJ110CA-L	GHE	BHE	110	122	135	1	177	3.4	1
SMCJ120A-L	SMCJ120CA-L	GHG	BHG	120	133	147	1	193	3.1	1
SMCJ130A-L	SMCJ130CA-L	GHK	BHK	130	144	159	1	209	2.9	1
SMCJ150A-L	SMCJ150CA-L	GHM	BHM	150	167	185	1	243	2.5	1
SMCJ160A-L	SMCJ160CA-L	GHP	BHP	160	178	197	1	259	2.3	1
SMCJ170A-L	SMCJ170CA-L	GHR	BHR	170	189	209	1	275	2.2	1
SMCJ180A-L	SMCJ180CA-L	GHT	BHT	180	201	222	1	292	2.1	1
SMCJ200A-L	SMCJ200CA-L	GHV	BHV	200	224	247	1	324	1.9	1
SMCJ220A-L	SMCJ220CA-L	GHX	BHX	220	246	272	1	356	1.7	1
SMCJ250A-L	SMCJ250CA-L	GHZ	BHZ	250	279	309	1	405	1.5	1
SMCJ300A-L	SMCJ300CA-L	GJE	BJE	300	335	371	1	486	1.3	1
SMCJ350A-L	SMCJ350CA-L	GJG	BJG	350	391	432	1	567	1.1	1
SMCJ400A-L	SMCJ400CA-L	GJK	BJK	400	447	494	1	648	0.9	1
SMCJ440A-L	SMCJ440CA-L	GJM	BJM	440	492	543	1	713	0.9	1



Fig.1 Peak Pulse Power Rating Curve

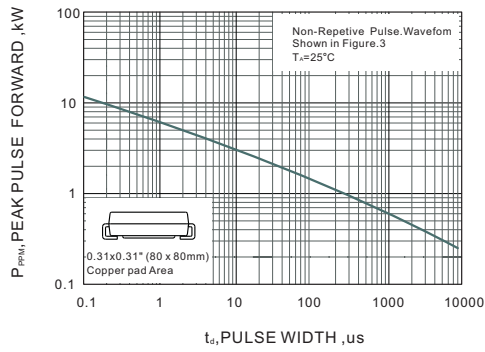

Fig.2 Pulse Waveform

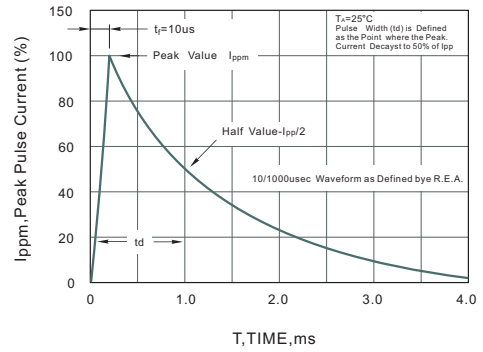

Fig.3 Forward Current Derating Curve

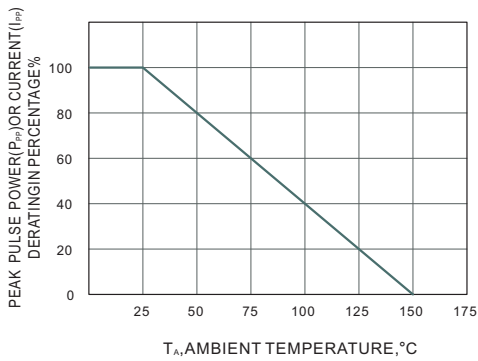

Fig.4 Typical Junction Capacitance

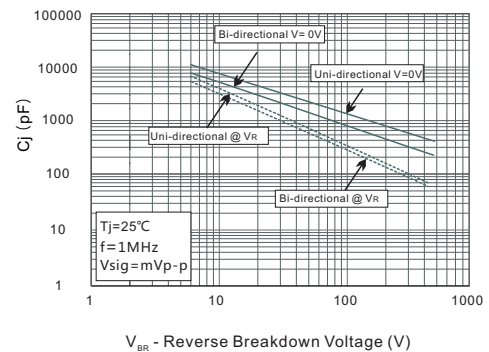
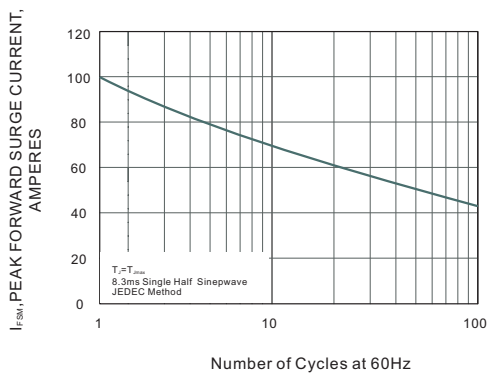

Fig.5 Maximum Non-Repetitive Peak Forward Surge Current





**PACKAGE OUTLINE**

Plastic surface mounted package; 2 leads

SMC



SMC mechanical data

UNIT		A	E	D	E <sub>1</sub>	A <sub>1</sub>	C	L	b
mm	max	2.62	7.0	6.2	8.0	0.21	0.31	1.6	3.25
	min	2.00	6.5	5.6	7.6	0.05	0.15	0.9	2.75
mil	max	103	276	244	315	8.3	12	63	128
	min	79	256	220	299	2.0	5.9	35	108

**The recommended mounting pad size**

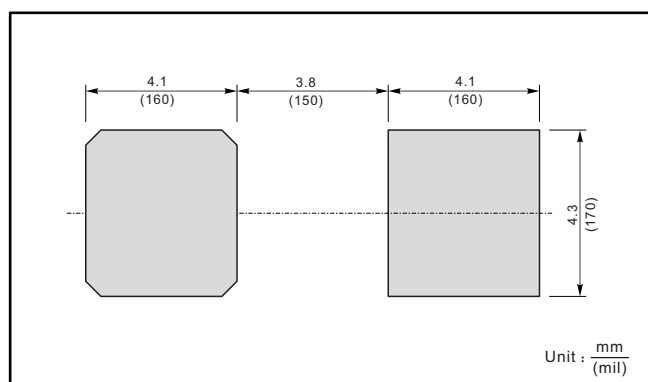

## X-ON Electronics

Largest Supplier of Electrical and Electronic Components

*Click to view similar products for [ESD Suppressors / TVS Diodes](#) category:*

*Click to view products by [Jingdao](#) manufacturer:*

Other Similar products are found below :

[60KS200C](#) [D18V0L1B2LP-7B](#) [D5V0F4U5P5-7](#) [NTE4902](#) [P4KE27CA](#) [P6KE11CA](#) [P6KE8.2A](#) [SA60CA](#) [SA64CA](#) [SMBJ12CATR](#)  
[SMBJ33CATR](#) [SMBJ6.5A](#) [SMBJ8.0A](#) [ESD101-B1-02ELS E6327](#) [ESD112-B1-02EL E6327](#) [ESD7451N2T5G](#) [19180-510](#) [CPDT-5V0USP-](#)  
[HF](#) [3.0SMCJ33CA-F](#) [3.0SMCJ36A-F](#) [HSPC16701B02TP](#) [JANTX1N6126A](#) [D3V3Q1B2DLP3-7](#) [D55V0M1B2WS-7](#) [SCM1293A-04SO](#)  
[ESD200-B1-CSP0201 E6327](#) [SM12-7](#) [CEN955 W/DATA](#) [VESD12A1A-HD1-GS08](#) [CPDQC5V0-HF](#) [D1213A-01LP4-7B](#) [ESD101-B1-02EL](#)  
[E6327](#) [AOZ8808DI-03](#) [5KP15A](#) [5KP48A](#) [5KP90A](#) [ESD3V3D7-TP](#) [15KPA36A-LF](#) [P4KE56CA](#) [P4KE68A](#) [P4KE91CATR](#) [P6KE120A](#)  
[P6KE13CA](#) [P6KE43CA](#) [P6KE6.8CA](#) [P6KE8.2](#) [P6SMBJ20CA](#) [JANTX1N6072A](#) [SR2835ESKG](#) [SA90CA](#)