



The SMCJ series is designed specifically to protect sensitive electronic equipment from voltage transients induced by lightning and other transient voltage events.

### FEATURES

- 1500W peak pulse power capability at 10/1000 $\mu$ s waveform
- For surface mounted applications to optimize board space
- Glass passivated chip junction
- Halogen free and RoHS compliant

### MECHANICAL DATA

- Case: SMC
- Terminals: Solderable per MIL-STD-750, Method 2026
- Approx. Weight: 0.22g (0.0077oz)

### PINNING

PIN	DESCRIPTION
1	Cathode
2	Anode

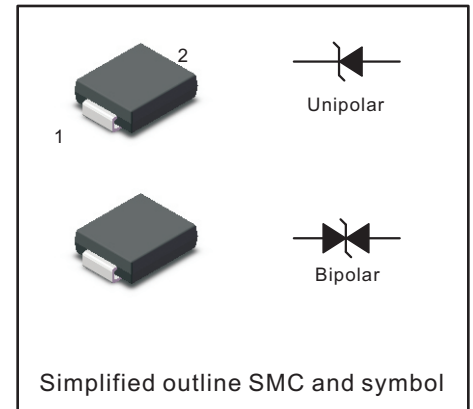

Parameter	Symbol	Value	Unit
Peak Pulse Power Dissipation on 10/1000 us waveform	$P_{PPM}$	1500	W
Peak Forward Surge Current, 8.3ms Single Half Sine-Wave Superimposed on Rated Load (JEDEC Method)	$I_{FSM}$ (UNI)	200	A
Power dissipation on Infinite heat sink at $T_A=50^{\circ}C$	$P_D$	6.5	W
Maximum instantaneous forward voltage at 100 A for unidirectional only	$V_F$	3.5	V
Peak Pulse Current on 10/1000 us waveform	$I_{PPM}$	See Next Table	A
Typical Thermal Resistance Junction to Ambient(Note 1)	$R_{\theta JA}$ $R_{\theta JL}$	75 15	$^{\circ}C/W$
Operating Junction Temperature and Storage Temperature Range	$T_j, T_{stg}$	-55 ~ +150	$^{\circ}C$

#### NOTES:

1. Mounted on 8 mm<sup>2</sup> (0.13mm thick) land areas.

Characteristics at Ta = 25°C

Type		Marking		Reverse Stand-off Voltage	Breakdown Voltage		Test Current	Max Clamping Voltage	Peak Pulse Current	Maximum Reverse Leakage
					V <sub>RMW</sub>	V <sub>BR</sub> @ I <sub>T</sub>				
UNI	BI	UNI	BI	V	Min(V)	Max(V)	mA	V	A	µA
SMCJ5.0A	SMCJ5.0CA	GDE	BDE	5	6.4	7	10	9.2	163	800
SMCJ6.0A	SMCJ6.0CA	GDG	BDG	6	6.67	7.37	10	10.3	145.7	800
SMCJ6.5A	SMCJ6.5CA	GDK	BDK	6.5	7.22	7.98	10	11.2	134	500
SMCJ7.0A	SMCJ7.0CA	GDM	BDM	7	7.78	8.6	10	12	125	200
SMCJ7.5A	SMCJ7.5CA	GDP	BDP	7.5	8.33	9.21	1	12.9	116.3	100
SMCJ8.0A	SMCJ8.0CA	GDR	BDR	8	8.89	9.83	1	13.6	110.3	50
SMCJ8.5A	SMCJ8.5CA	GDT	BDT	8.5	9.44	10.4	1	14.4	104.2	20
SMCJ9.0A	SMCJ9.0CA	GDV	BDV	9	10	11.1	1	15.4	97.4	10
SMCJ10A	SMCJ10CA	GDX	BDX	10	11.1	12.3	1	17	88.3	5
SMCJ11A	SMCJ11CA	GDZ	BDZ	11	12.2	13.5	1	18.2	82.5	1
SMCJ12A	SMCJ12CA	GEE	BEE	12	13.3	14.7	1	19.9	75.4	1
SMCJ13A	SMCJ13CA	GEG	BEG	13	14.4	15.9	1	21.5	69.8	1
SMCJ14A	SMCJ14CA	GEK	BEK	14	15.6	17.2	1	23.2	64.7	1
SMCJ15A	SMCJ15CA	GEM	BEM	15	16.7	18.5	1	24.4	61.5	1
SMCJ16A	SMCJ16CA	GEP	BEP	16	17.8	19.7	1	26	57.7	1
SMCJ17A	SMCJ17CA	GER	BER	17	18.9	20.9	1	27.6	54.4	1
SMCJ18A	SMCJ18CA	GET	BET	18	20	22.1	1	29.2	51.4	1
SMCJ20A	SMCJ20CA	GEV	BEV	20	22.2	24.5	1	32.4	46.3	1
SMCJ22A	SMCJ22CA	GEX	BEX	22	24.4	26.9	1	35.5	42.3	1
SMCJ24A	SMCJ24CA	GEZ	BEZ	24	26.7	29.5	1	38.9	38.6	1
SMCJ26A	SMCJ26CA	GFE	BFE	26	28.9	31.9	1	42.1	35.7	1
SMCJ28A	SMCJ28CA	GFG	BFG	28	31.1	34.4	1	45.4	33.1	1
SMCJ30A	SMCJ30CA	GFK	BFK	30	33.3	36.8	1	48.4	31	1
SMCJ33A	SMCJ33CA	GFM	BFM	33	36.7	40.6	1	53.3	28.2	1
SMCJ36A	SMCJ36CA	GFP	BFP	36	40	44.2	1	58.1	25.9	1
SMCJ40A	SMCJ40CA	GFR	BFR	40	44.4	49.1	1	64.5	23.3	1
SMCJ43A	SMCJ43CA	GFT	BFT	43	47.8	52.8	1	69.4	21.7	1
SMCJ45A	SMCJ45CA	GFV	BFV	45	50	55.3	1	72.7	20.6	1
SMCJ48A	SMCJ48CA	GFX	BFX	48	53.3	58.9	1	77.4	19.4	1
SMCJ51A	SMCJ51CA	GFZ	BFZ	51	56.7	62.7	1	82.4	18.2	1
SMCJ54A	SMCJ54CA	GGE	BGE	54	60	66.3	1	87.1	17.3	1
SMCJ58A	SMCJ58CA	GGG	BGG	58	64.4	71.2	1	93.6	16.1	1
SMCJ60A	SMCJ60CA	GGK	BGK	60	66.7	73.7	1	96.8	15.5	1
SMCJ64A	SMCJ64CA	GGM	BGM	64	71.1	78.6	1	103	14.6	1
SMCJ70A	SMCJ70CA	GGP	BGP	70	77.8	86	1	113	13.3	1
SMCJ75A	SMCJ75CA	GGR	BGR	75	83.3	92.1	1	121	12.4	1
SMCJ78A	SMCJ78CA	GGT	BGT	78	86.7	95.8	1	126	11.9	1
SMCJ85A	SMCJ85CA	GGV	BGV	85	94.4	104	1	137	11	1
SMCJ90A	SMCJ90CA	GGX	BGX	90	100	111	1	146	10.3	1
SMCJ100A	SMCJ100CA	GGZ	BGZ	100	111	123	1	162	9.3	1
SMCJ110A	SMCJ110CA	GHE	BHE	110	122	135	1	177	8.5	1
SMCJ120A	SMCJ120CA	GHG	BHG	120	133	147	1	193	7.8	1
SMCJ130A	SMCJ130CA	GHK	BHK	130	144	159	1	209	7.2	1
SMCJ150A	SMCJ150CA	GHM	BHM	150	167	185	1	243	6.2	1
SMCJ160A	SMCJ160CA	GHP	BHP	160	178	197	1	259	5.8	1
SMCJ170A	SMCJ170CA	GHR	BHR	170	189	209	1	275	5.5	1
SMCJ180A	SMCJ180CA	GHT	BHT	180	201	222	1	292	5.1	1
SMCJ200A	SMCJ200CA	GHV	BHV	200	224	247	1	324	4.6	1
SMCJ220A	SMCJ220CA	GHX	BHX	220	246	272	1	356	4.2	1
SMCJ250A	SMCJ250CA	GHZ	BHZ	250	279	309	1	405	3.7	1
SMCJ300A	SMCJ300CA	GJE	BJE	300	335	371	1	486	3.1	1
SMCJ350A	SMCJ350CA	GJG	BJG	350	391	432	1	567	2.6	1
SMCJ400A	SMCJ400CA	GJK	BJK	400	447	494	1	648	2.3	1
SMCJ440A	SMCJ440CA	GJM	BJM	440	492	543	1	713	2.1	1



Fig.1 Peak Pulse Power Rating Curve

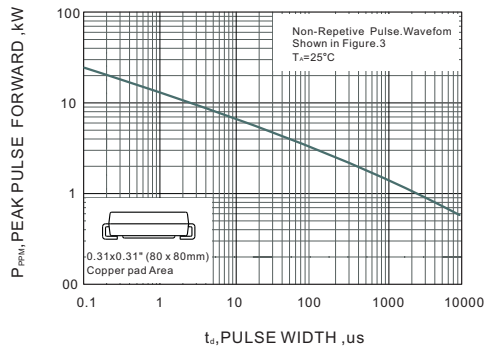

Fig.2 Pulse Waveform

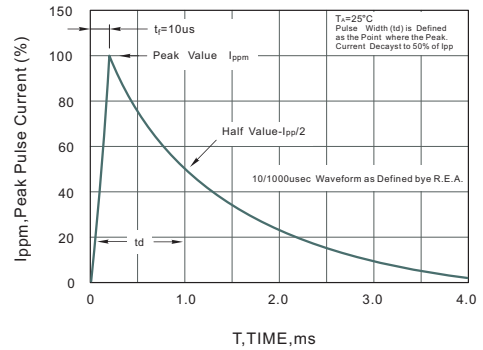

Fig.3 Forward Current Derating Curve

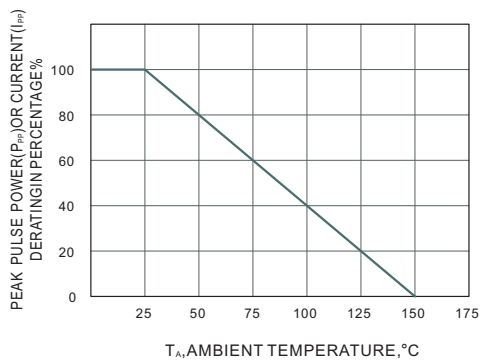

Fig.4 Typical Junction Capacitance

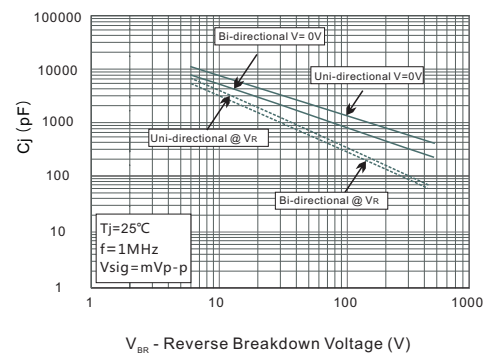
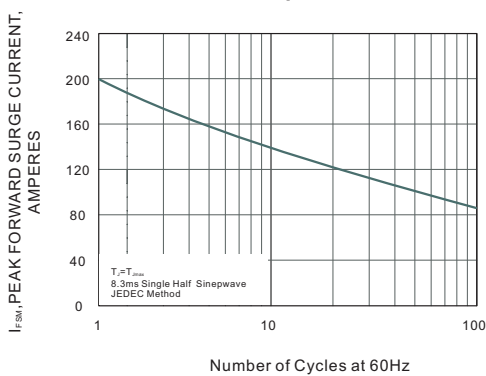

Fig.5 Maximum Non-Repetitive Peak Forward Surge Current





**PACKAGE OUTLINE**

Plastic surface mounted package; 2 leads

SMC



SMC mechanical data

UNIT		A	E	D	$E_1$	$A_1$	C	L	b
mm	max	2.62	7.0	6.2	8.0	0.21	0.31	1.6	3.25
	min	2.00	6.5	5.6	7.6	0.05	0.15	0.9	2.75
mil	max	103	276	244	315	8.3	12	63	128
	min	79	256	220	299	2.0	5.9	35	108

**The recommended mounting pad size**

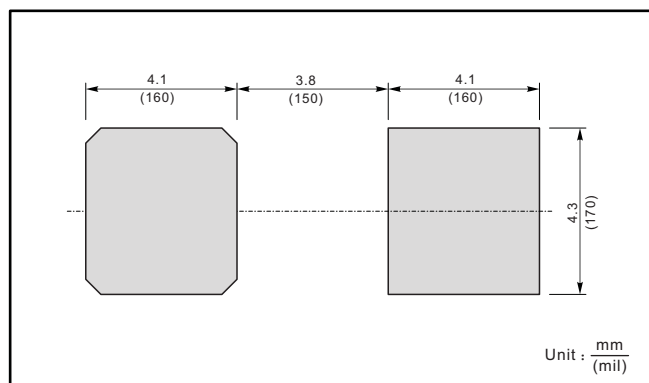

## X-ON Electronics

Largest Supplier of Electrical and Electronic Components

*Click to view similar products for [ESD Suppressors / TVS Diodes](#) category:*

*Click to view products by [Jingdao](#) manufacturer:*

Other Similar products are found below :

[NTE4902](#) [P4SMAJ15A](#) [P4SMAJ26A](#) [SMAJ400CA-TP](#) [TGL34-47CA](#) [ESDAULC45-1BF4](#) [SM1605E3/TR13](#) [SMF20A-TP](#) [P4SMAJ12A](#)  
[CPDUR24V-HF](#) [CPDQC5V0USP-HF](#) [CPDQC5V0-HF](#) [MPLAD30KP280A](#) [MPLAD30KP45CAE3](#) [MMBZ27VCLQ-7-F](#) [MMAD1108/TR13](#)  
[MPLAD30KP24A](#) [MPLAD30KP30CAE3](#) [ACPDQC5V0R-HF](#) [DFLT170A-7](#) [NTE4900](#) [NTE4926](#) [NTE4938](#) [JANTX1N6144A](#)  
[JANTX1N6057A](#) [SMF22A-TP](#) [SMF12A-TP](#) [SLVU2.8-TP](#) [SMLJ6.5CA-TP](#) [SMAJ6.5CA-TP](#) [MMAD1108E3/TR13](#) [JANTX1N6160A](#)  
[D5V0M1U2LP3-7](#) [SMAJ400A-TP](#) [AOZ8811DT-03](#) [AOZ8831DI-05](#) [AOZ8831DT-03](#) [SMAJ188CA](#) [3SMC33CA BK](#) [CPDQC3V3C-HF](#)  
[CPDQC12VE-HF](#) [GRPADATAJANTX1N6041A](#) [MPLAD30KP170CA](#) [82357120100](#) [5.0SMLJ15CA-TP](#) [5KP18A-TP](#) [P6KE8.2A-TP](#)  
[MPLAD30KP43CAE3](#) [SMAJ43A-TP](#) [D26V0H1U2LP16-7](#)