



The SMCJ series is designed specifically to protect sensitive electronic equipment from voltage transients induced by lightning and other transient voltage events.

### FEATURES

- 1500W peak pulse power capability at 10/1000 $\mu$ s waveform
- For surface mounted applications to optimize board space
- Glass passivated chip junction
- Halogen free and RoHS compliant

### MECHANICAL DATA

- Case: SMC
- Terminals: Solderable per MIL-STD-750, Method 2026
- Approx. Weight: 0.22g (0.0077oz)

### PINNING

| PIN | DESCRIPTION |
|-----|-------------|
| 1   | Cathode     |
| 2   | Anode       |

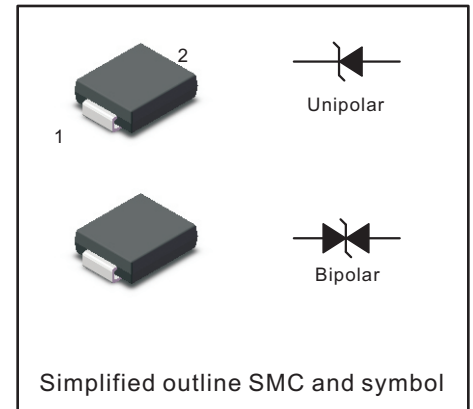

| Parameter   | Symbol                             | Value          | Unit          |
|---|------------------------------------|----------------|---------------|
| Peak Pulse Power Dissipation on 10/1000 us waveform   | $P_{PPM}$                          | 1500           | W             |
| Peak Forward Surge Current, 8.3ms Single Half Sine-Wave Superimposed on Rated Load (JEDEC Method) | $I_{FSM}$<br>(UNI)                 | 200            | A             |
| Power dissipation on Infinite heat sink at $T_A=50^{\circ}C$                                      | $P_D$                              | 6.5            | W             |
| Maximum instantaneous forward voltage at 100 A for unidirectional only                            | $V_F$                              | 3.5            | V             |
| Peak Pulse Current on 10/1000 us waveform   | $I_{PPM}$                          | See Next Table | A             |
| Typical Thermal Resistance Junction to Ambient(Note 1)  | $R_{\theta JA}$<br>$R_{\theta JL}$ | 75<br>15       | $^{\circ}C/W$ |
| Operating Junction Temperature and Storage Temperature Range                                      | $T_j, T_{stg}$                     | -55 ~ +150     | $^{\circ}C$   |

### NOTES:

1. Mounted on 8 mm<sup>2</sup> (0.13mm thick) land areas.

Characteristics at Ta = 25°C

| Type     |           | Marking |     | Reverse Stand-off Voltage | Breakdown Voltage |                                  | Test Current | Max Clamping Voltage | Peak Pulse Current | Maximum Reverse Leakage |
|----------|-----------|---------|-----|---------------------------|-------------------|----------------------------------|--------------|----------------------|--------------------|-------------------------|
|          |           |         |     |                           | V <sub>RMW</sub>  | V <sub>BR</sub> @ I <sub>T</sub> |              |                      |                    |                         |
| UNI      | BI        | UNI     | BI  | V                         | Min(V)            | Max(V)                           | mA           | V                    | A                  | µA                      |
| SMCJ5.0A | SMCJ5.0CA | GDE     | BDE | 5                         | 6.4               | 7                                | 10           | 9.2                  | 163                | 800                     |
| SMCJ6.0A | SMCJ6.0CA | GDG     | BDG | 6                         | 6.67              | 7.37                             | 10           | 10.3                 | 145.7              | 800                     |
| SMCJ6.5A | SMCJ6.5CA | GDK     | BDK | 6.5                       | 7.22              | 7.98                             | 10           | 11.2                 | 134                | 500                     |
| SMCJ7.0A | SMCJ7.0CA | GDM     | BDM | 7                         | 7.78              | 8.6                              | 10           | 12                   | 125                | 200                     |
| SMCJ7.5A | SMCJ7.5CA | GDP     | BDP | 7.5                       | 8.33              | 9.21                             | 1            | 12.9                 | 116.3              | 100                     |
| SMCJ8.0A | SMCJ8.0CA | GDR     | BDR | 8                         | 8.89              | 9.83                             | 1            | 13.6                 | 110.3              | 50                      |
| SMCJ8.5A | SMCJ8.5CA | GDT     | BDT | 8.5                       | 9.44              | 10.4                             | 1            | 14.4                 | 104.2              | 20                      |
| SMCJ9.0A | SMCJ9.0CA | GDV     | BDV | 9                         | 10                | 11.1                             | 1            | 15.4                 | 97.4               | 10                      |
| SMCJ10A  | SMCJ10CA  | GDX     | BDX | 10                        | 11.1              | 12.3                             | 1            | 17                   | 88.3               | 5                       |
| SMCJ11A  | SMCJ11CA  | GDZ     | BDZ | 11                        | 12.2              | 13.5                             | 1            | 18.2                 | 82.5               | 1                       |
| SMCJ12A  | SMCJ12CA  | GEE     | BEE | 12                        | 13.3              | 14.7                             | 1            | 19.9                 | 75.4               | 1                       |
| SMCJ13A  | SMCJ13CA  | GEG     | BEG | 13                        | 14.4              | 15.9                             | 1            | 21.5                 | 69.8               | 1                       |
| SMCJ14A  | SMCJ14CA  | GEK     | BEK | 14                        | 15.6              | 17.2                             | 1            | 23.2                 | 64.7               | 1                       |
| SMCJ15A  | SMCJ15CA  | GEM     | BEM | 15                        | 16.7              | 18.5                             | 1            | 24.4                 | 61.5               | 1                       |
| SMCJ16A  | SMCJ16CA  | GEP     | BEP | 16                        | 17.8              | 19.7                             | 1            | 26                   | 57.7               | 1                       |
| SMCJ17A  | SMCJ17CA  | GER     | BER | 17                        | 18.9              | 20.9                             | 1            | 27.6                 | 54.4               | 1                       |
| SMCJ18A  | SMCJ18CA  | GET     | BET | 18                        | 20                | 22.1                             | 1            | 29.2                 | 51.4               | 1                       |
| SMCJ20A  | SMCJ20CA  | GEV     | BEV | 20                        | 22.2              | 24.5                             | 1            | 32.4                 | 46.3               | 1                       |
| SMCJ22A  | SMCJ22CA  | GEX     | BEX | 22                        | 24.4              | 26.9                             | 1            | 35.5                 | 42.3               | 1                       |
| SMCJ24A  | SMCJ24CA  | GEZ     | BEZ | 24                        | 26.7              | 29.5                             | 1            | 38.9                 | 38.6               | 1                       |
| SMCJ26A  | SMCJ26CA  | GFE     | BFE | 26                        | 28.9              | 31.9                             | 1            | 42.1                 | 35.7               | 1                       |
| SMCJ28A  | SMCJ28CA  | GFG     | BFG | 28                        | 31.1              | 34.4                             | 1            | 45.4                 | 33.1               | 1                       |
| SMCJ30A  | SMCJ30CA  | GFK     | BFK | 30                        | 33.3              | 36.8                             | 1            | 48.4                 | 31                 | 1                       |
| SMCJ33A  | SMCJ33CA  | GFM     | BFM | 33                        | 36.7              | 40.6                             | 1            | 53.3                 | 28.2               | 1                       |
| SMCJ36A  | SMCJ36CA  | GFP     | BFP | 36                        | 40                | 44.2                             | 1            | 58.1                 | 25.9               | 1                       |
| SMCJ40A  | SMCJ40CA  | GFR     | BFR | 40                        | 44.4              | 49.1                             | 1            | 64.5                 | 23.3               | 1                       |
| SMCJ43A  | SMCJ43CA  | GFT     | BFT | 43                        | 47.8              | 52.8                             | 1            | 69.4                 | 21.7               | 1                       |
| SMCJ45A  | SMCJ45CA  | GFV     | BFV | 45                        | 50                | 55.3                             | 1            | 72.7                 | 20.6               | 1                       |
| SMCJ48A  | SMCJ48CA  | GFX     | BFX | 48                        | 53.3              | 58.9                             | 1            | 77.4                 | 19.4               | 1                       |
| SMCJ51A  | SMCJ51CA  | GFZ     | BFZ | 51                        | 56.7              | 62.7                             | 1            | 82.4                 | 18.2               | 1                       |
| SMCJ54A  | SMCJ54CA  | GGE     | BGE | 54                        | 60                | 66.3                             | 1            | 87.1                 | 17.3               | 1                       |
| SMCJ58A  | SMCJ58CA  | GGG     | BGG | 58                        | 64.4              | 71.2                             | 1            | 93.6                 | 16.1               | 1                       |
| SMCJ60A  | SMCJ60CA  | GGK     | BGK | 60                        | 66.7              | 73.7                             | 1            | 96.8                 | 15.5               | 1                       |
| SMCJ64A  | SMCJ64CA  | GGM     | BGM | 64                        | 71.1              | 78.6                             | 1            | 103                  | 14.6               | 1                       |
| SMCJ70A  | SMCJ70CA  | GGP     | BGP | 70                        | 77.8              | 86                               | 1            | 113                  | 13.3               | 1                       |
| SMCJ75A  | SMCJ75CA  | GGR     | BGR | 75                        | 83.3              | 92.1                             | 1            | 121                  | 12.4               | 1                       |
| SMCJ78A  | SMCJ78CA  | GGT     | BGT | 78                        | 86.7              | 95.8                             | 1            | 126                  | 11.9               | 1                       |
| SMCJ85A  | SMCJ85CA  | GGV     | BGV | 85                        | 94.4              | 104                              | 1            | 137                  | 11                 | 1                       |
| SMCJ90A  | SMCJ90CA  | GGX     | BGX | 90                        | 100               | 111                              | 1            | 146                  | 10.3               | 1                       |
| SMCJ100A | SMCJ100CA | GGZ     | BGZ | 100                       | 111               | 123                              | 1            | 162                  | 9.3                | 1                       |
| SMCJ110A | SMCJ110CA | GHE     | BHE | 110                       | 122               | 135                              | 1            | 177                  | 8.5                | 1                       |
| SMCJ120A | SMCJ120CA | GHG     | BHG | 120                       | 133               | 147                              | 1            | 193                  | 7.8                | 1                       |
| SMCJ130A | SMCJ130CA | GHK     | BHK | 130                       | 144               | 159                              | 1            | 209                  | 7.2                | 1                       |
| SMCJ150A | SMCJ150CA | GHM     | BHM | 150                       | 167               | 185                              | 1            | 243                  | 6.2                | 1                       |
| SMCJ160A | SMCJ160CA | GHP     | BHP | 160                       | 178               | 197                              | 1            | 259                  | 5.8                | 1                       |
| SMCJ170A | SMCJ170CA | GHR     | BHR | 170                       | 189               | 209                              | 1            | 275                  | 5.5                | 1                       |
| SMCJ180A | SMCJ180CA | GHT     | BHT | 180                       | 201               | 222                              | 1            | 292                  | 5.1                | 1                       |
| SMCJ200A | SMCJ200CA | GHV     | BHV | 200                       | 224               | 247                              | 1            | 324                  | 4.6                | 1                       |
| SMCJ220A | SMCJ220CA | GHX     | BHX | 220                       | 246               | 272                              | 1            | 356                  | 4.2                | 1                       |
| SMCJ250A | SMCJ250CA | GHZ     | BHZ | 250                       | 279               | 309                              | 1            | 405                  | 3.7                | 1                       |
| SMCJ300A | SMCJ300CA | GJE     | BJE | 300                       | 335               | 371                              | 1            | 486                  | 3.1                | 1                       |
| SMCJ350A | SMCJ350CA | GJG     | BJG | 350                       | 391               | 432                              | 1            | 567                  | 2.6                | 1                       |
| SMCJ400A | SMCJ400CA | GJK     | BJK | 400                       | 447               | 494                              | 1            | 648                  | 2.3                | 1                       |
| SMCJ440A | SMCJ440CA | GJM     | BJM | 440                       | 492               | 543                              | 1            | 713                  | 2.1                | 1                       |



Fig.1 Peak Pulse Power Rating Curve

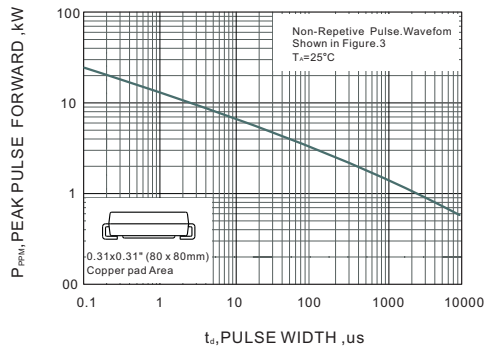

Fig.2 Pulse Waveform

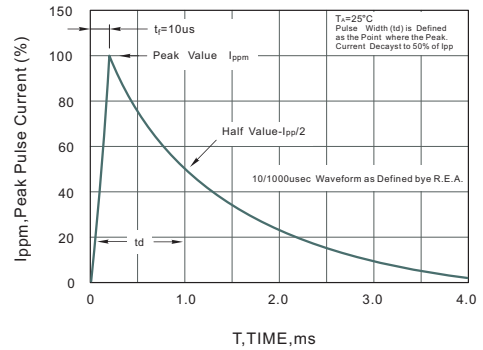

Fig.3 Forward Current Derating Curve

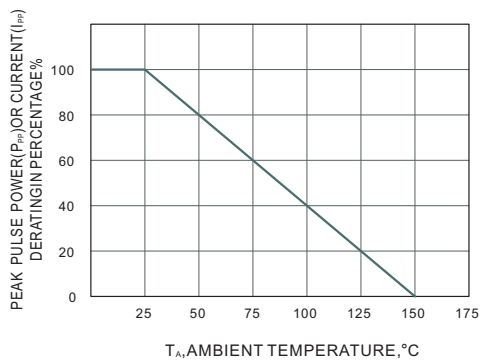

Fig.4 Typical Junction Capacitance

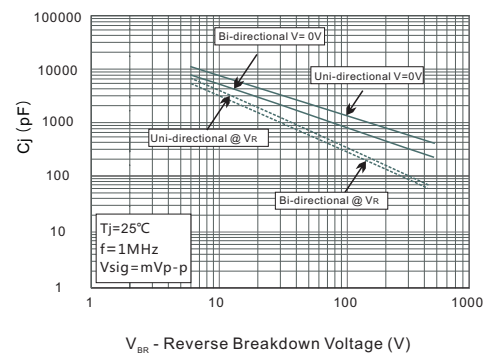
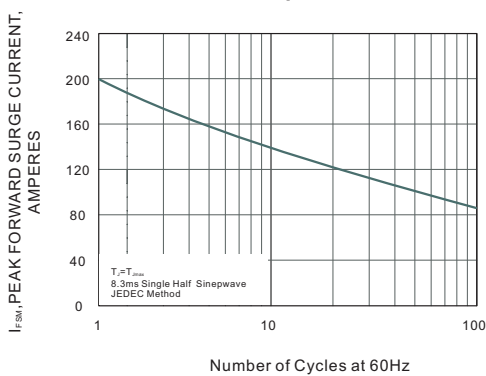

Fig.5 Maximum Non-Repetitive Peak Forward Surge Current





**PACKAGE OUTLINE**

Plastic surface mounted package; 2 leads

SMC



SMC mechanical data

| UNIT |     | A    | E   | D   | E <sub>1</sub> | A <sub>1</sub> | C    | L   | b    |
|------|-----|------|-----|-----|----------------|----------------|------|-----|------|
| mm   | max | 2.62 | 7.0 | 6.2 | 8.0            | 0.21           | 0.31 | 1.6 | 3.25 |
|      | min | 2.00 | 6.5 | 5.6 | 7.6            | 0.05           | 0.15 | 0.9 | 2.75 |
| mil  | max | 103  | 276 | 244 | 315            | 8.3            | 12   | 63  | 128  |
|      | min | 79   | 256 | 220 | 299            | 2.0            | 5.9  | 35  | 108  |

**The recommended mounting pad size**

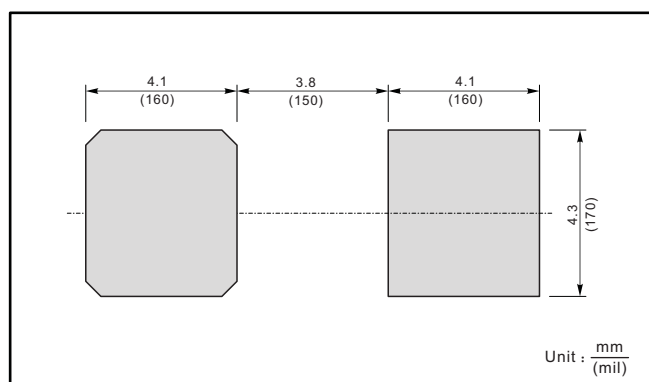

## X-ON Electronics

Largest Supplier of Electrical and Electronic Components

*Click to view similar products for [ESD Suppressors / TVS Diodes](#) category:*

*Click to view products by [Jingdao](#) manufacturer:*

Other Similar products are found below :

[NTE4902](#) [P4SMAJ15A](#) [P4SMAJ26A](#) [SMAJ400CA-TP](#) [TGL34-47CA](#) [ESDAULC45-1BF4](#) [SM1605E3/TR13](#) [SMF20A-TP](#) [P4SMAJ12A](#)  
[CPDUR24V-HF](#) [CPDQC5V0USP-HF](#) [CPDQC5V0-HF](#) [MPLAD30KP45CAE3](#) [MMBZ27VCLQ-7-F](#) [MMAD1108/TR13](#) [MPLAD30KP24A](#)  
[ACPDQC5V0R-HF](#) [DFLT170A-7](#) [NTE4900](#) [NTE4926](#) [NTE4938](#) [SMF22A-TP](#) [SMF12A-TP](#) [SLVU2.8-TP](#) [SMLJ6.5CA-TP](#) [SMAJ6.5CA-](#)  
[TP](#) [MMAD1108E3/TR13](#) [D5V0M1U2LP3-7](#) [SMAJ400A-TP](#) [AOZ8811DT-03](#) [AOZ8831DI-05](#) [AOZ8831DT-03](#) [SMAJ188CA](#) [3SMC33CA](#)  
[BK](#) [CPDQC3V3C-HF](#) [CPDQC12VE-HF](#) [MPLAD30KP170CA](#) [82357120100](#) [5.0SMLJ15CA-TP](#) [5KP18A-TP](#) [P6KE8.2A-TP](#)  
[MPLAD30KP43CAE3](#) [SMAJ43A-TP](#) [D5V0F6U8LP33-7](#) [TVS5501V10MUT5G](#) [5.0SMLJ24CA-TP](#) [SMAJ110CA-TP](#) [MPLAD15KP75CAE3](#)  
[MMAD1103e3/TR13](#) [DFLT40AQ-7](#)