



Surface mount transient voltage suppressor power 200 watts

Stand-Off Voltage : 5.0V~440V

### FEATURES

- For surface mounted applications in order to optimize board space.
- Low profile package
- Glass passivated junction
- Low inductance
- Plastic package has Underwriters Laboratory Flammability

### MECHANICAL DATA

- Case: SOD-123FL
- Terminals: Solderable per MIL-STD-750, Method 2026
- Approx. Weight:15mg/0.00048oz

### PINNING

| PIN | DESCRIPTION |
|-----|-------------|
| 1   | Cathode     |
| 2   | Anode       |

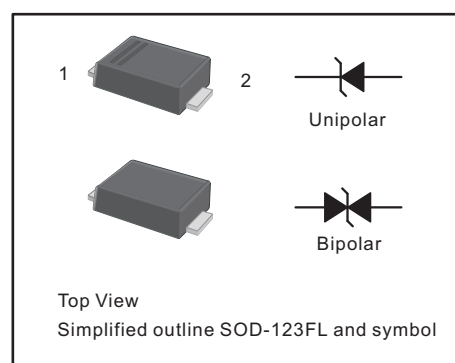

### Maximum Ratings and Electrical characteristics

Ratings at 25 °C ambient temperature unless otherwise specified.

| Parameter  | Symbol             | Value       | Unit |
|--|--------------------|-------------|------|
| Peak Pulse Power Dissipation on TA=25°C (Note 1,2,5, Fig1) | $P_{PPM}$          | 200         | W    |
| Peak Forward Surge Current (Note 3)                        | $I_{FSM}$<br>(UNI) | 20          | A    |
| Peak Pulse Current on 10/1000 us waveform (Note 1) Fig 2   | $I_{PPM}$          | see Table 1 | A    |
| Steady State Power Dissipation (Note 4)                    | $P_{M(AV)}$        | 1           | W    |
| Operating Junction and Storage Range                       | $T_J, T_{STG}$     | -55 to +150 | °C   |
| Typical Thermal Resistance                                 | $R_{\theta JA}$    | 180         | °C/W |

### NOTES

1. Non-repetitive current pulse per Fig 3 and derated above  $T_A=25^\circ\text{C}$  per Fig 2
2. Mounted on  $5\text{mm}^2$  copper pads to each terminal
3. 8.3ms single half sinewave, or equivalent square wave duty cycle=4 pulses per minutes maximum
4. lead temperature at  $T_L=75^\circ\text{C}$
5. Peak pulse powe. waveform is  $t_p=10/1000\text{us}$
6. A transient suppressor is selected according to the working peak reverse voltage( $V_{RWM}$ ), Which Should be equal to or greater than the DC or continuous peak operating voltage level



Characteristics at Ta = 25°C

Table 1

| Type    |          | Marking |      | V <sub>RWM</sub> | Breakdown Voltage                |      | Test Current   | Reverse Leakage                   | Max. Clamp Voltage               | Peak Pulse Current |
|---------|----------|---------|------|------------------|----------------------------------|------|----------------|-----------------------------------|----------------------------------|--------------------|
|         |          |         |      |                  | V <sub>BR</sub> @ I <sub>T</sub> |      |                |                                   |                                  |                    |
|         |          |         |      |                  | Min                              | Max  | I <sub>T</sub> | I <sub>R</sub> @ V <sub>RWM</sub> | V <sub>C</sub> @ I <sub>PP</sub> | I <sub>PP</sub>    |
| Uni     | BI       | Uni     | BI   | V                | V                                | V    | mA             | μA                                | V                                | A                  |
| SMF5.0A | SMF5.0CA | AE      | CAE  | 5                | 6.4                              | 7    | 10             | 400                               | 9.2                              | 21.7               |
| SMF6.0A | SMF6.0CA | AG      | CAG  | 6                | 6.67                             | 7.37 | 10             | 400                               | 10.3                             | 19.4               |
| SMF6.5A | SMF6.5CA | AK      | CAK  | 6.5              | 7.22                             | 7.98 | 10             | 250                               | 11.2                             | 17.9               |
| SMF7.0A | SMF7.0CA | AM      | CAM  | 7                | 7.78                             | 8.6  | 10             | 100                               | 12                               | 16.7               |
| SMF7.5A | SMF7.5CA | AP      | CAP  | 7.5              | 8.33                             | 9.21 | 1              | 50                                | 12.9                             | 15.5               |
| SMF8.0A | SMF8.0CA | AR      | CAR  | 8                | 8.89                             | 9.83 | 1              | 25                                | 13.6                             | 14.7               |
| SMF8.5A | SMF8.5CA | AT      | CAT  | 8.5              | 9.44                             | 10.4 | 1              | 10                                | 14.4                             | 13.9               |
| SMF9.0A | SMF9.0CA | AV      | CAV  | 9                | 10                               | 11.1 | 1              | 5                                 | 15.4                             | 13                 |
| SMF10A  | SMF10CA  | AX      | CAX  | 10               | 11.1                             | 12.3 | 1              | 2.5                               | 17                               | 11.8               |
| SMF11A  | SMF11CA  | AZ      | CAZ  | 11               | 12.2                             | 13.5 | 1              | 2.5                               | 18.2                             | 11                 |
| SMF12A  | SMF12CA  | BE      | CBE  | 12               | 13.3                             | 14.7 | 1              | 2.5                               | 19.9                             | 10.1               |
| SMF13A  | SMF13CA  | BG      | CBG  | 13               | 14.4                             | 15.9 | 1              | 1                                 | 21.5                             | 9.3                |
| SMF14A  | SMF14CA  | BK      | CBK  | 14               | 15.6                             | 17.2 | 1              | 1                                 | 23.2                             | 8.6                |
| SMF15A  | SMF15CA  | BM      | CBM  | 15               | 16.7                             | 18.5 | 1              | 1                                 | 24.4                             | 8.2                |
| SMF16A  | SMF16CA  | BP      | CBP  | 16               | 17.8                             | 19.7 | 1              | 1                                 | 26                               | 7.7                |
| SMF17A  | SMF17CA  | BR      | CBR  | 17               | 18.9                             | 20.9 | 1              | 1                                 | 27.6                             | 7.2                |
| SMF18A  | SMF18CA  | BT      | CBT  | 18               | 20                               | 22.1 | 1              | 1                                 | 29.2                             | 6.8                |
| SMF20A  | SMF20CA  | BV      | CBV  | 20               | 22.2                             | 24.5 | 1              | 1                                 | 32.4                             | 6.2                |
| SMF22A  | SMF22CA  | BX      | CBX  | 22               | 24.4                             | 26.9 | 1              | 1                                 | 35.5                             | 5.6                |
| SMF24A  | SMF24CA  | BZ      | CBZ  | 24               | 26.7                             | 29.5 | 1              | 1                                 | 38.9                             | 5.1                |
| SMF26A  | SMF26CA  | CE      | CCE  | 26               | 28.9                             | 31.9 | 1              | 1                                 | 42.1                             | 4.8                |
| SMF28A  | SMF28CA  | CG      | CCG  | 28               | 31.1                             | 34.4 | 1              | 1                                 | 45.4                             | 4.4                |
| SMF30A  | SMF30CA  | CK      | CCK  | 30               | 33.3                             | 36.8 | 1              | 1                                 | 48.4                             | 4.1                |
| SMF33A  | SMF33CA  | CM      | CCM  | 33               | 36.7                             | 40.6 | 1              | 1                                 | 53.3                             | 3.8                |
| SMF36A  | SMF36CA  | CP      | CCP  | 36               | 40                               | 44.2 | 1              | 1                                 | 58.1                             | 3.4                |
| SMF40A  | SMF40CA  | CR      | CCR  | 40               | 44.4                             | 49.1 | 1              | 1                                 | 64.5                             | 3.1                |
| SMF43A  | SMF43CA  | CT      | CCT  | 43               | 47.8                             | 52.8 | 1              | 1                                 | 69.4                             | 2.9                |
| SMF45A  | SMF45CA  | CV      | CCV  | 45               | 50                               | 55.3 | 1              | 1                                 | 72.7                             | 2.8                |
| SMF48A  | SMF48CA  | CX      | CCX  | 48               | 53.3                             | 58.9 | 1              | 1                                 | 77.4                             | 2.6                |
| SMF51A  | SMF51CA  | CZ      | CCZ  | 51               | 56.7                             | 62.7 | 1              | 1                                 | 82.4                             | 2.4                |
| SMF54A  | SMF54CA  | DE      | CDE  | 54               | 60                               | 66.3 | 1              | 1                                 | 87.1                             | 2.3                |
| SMF58A  | SMF58CA  | DG      | CDG  | 58               | 64.4                             | 71.2 | 1              | 1                                 | 93.6                             | 2.1                |
| SMF60A  | SMF60CA  | DK      | CDK  | 60               | 66.7                             | 73.7 | 1              | 1                                 | 96.8                             | 1.8                |
| SMF64A  | SMF64CA  | DM      | CDM  | 64               | 71.1                             | 78.6 | 1              | 1                                 | 103                              | 1.7                |
| SMF70A  | SMF70CA  | DP      | CDP  | 70               | 77.8                             | 86   | 1              | 1                                 | 113                              | 1.5                |
| SMF75A  | SMF75CA  | DR      | CDR  | 75               | 83.3                             | 92.1 | 1              | 1                                 | 121                              | 1.4                |
| SMF78A  | SMF78CA  | DT      | CDT  | 78               | 86.7                             | 95.8 | 1              | 1                                 | 126                              | 1.4                |
| SMF85A  | SMF85CA  | DV      | CDV  | 85               | 94.4                             | 104  | 1              | 1                                 | 137                              | 1.3                |
| SMF90A  | SMF90CA  | DX      | CDX  | 90               | 100                              | 111  | 1              | 1                                 | 146                              | 1.2                |
| SMF100A | SMF100CA | DZ      | CDZ  | 100              | 111                              | 123  | 1              | 1                                 | 162                              | 1.1                |
| SMF110A | SMF110CA | EE      | CEE  | 110              | 122                              | 135  | 1              | 1                                 | 177                              | 1                  |
| SMF120A | SMF120CA | EG      | CEG  | 120              | 133                              | 147  | 1              | 1                                 | 193                              | 0.9                |
| SMF130A | SMF130CA | EK      | CEK  | 130              | 144                              | 159  | 1              | 1                                 | 209                              | 0.8                |
| SMF150A | SMF150CA | EM      | CEM  | 150              | 167                              | 185  | 1              | 1                                 | 243                              | 0.7                |
| SMF160A | SMF160CA | EP      | CEP  | 160              | 178                              | 197  | 1              | 1                                 | 259                              | 0.7                |
| SMF170A | SMF170CA | ER      | CER  | 170              | 189                              | 209  | 1              | 1                                 | 275                              | 0.6                |
| SMF180A | SMF180CA | ET      | CET  | 180              | 201                              | 222  | 1              | 1                                 | 292                              | 0.5                |
| SMF190A | SMF190CA | EV      | CEV  | 190              | 211                              | 232  | 1              | 1                                 | 308                              | 0.5                |
| SMF200A | SMF200CA | EX      | CEX  | 200              | 224                              | 247  | 1              | 1                                 | 324                              | 0.5                |
| SMF220A | SMF220CA | E22     | CE22 | 220              | 246                              | 272  | 1              | 1                                 | 356                              | 0.5                |
| SMF250A | SMF250CA | E25     | CE25 | 250              | 279                              | 309  | 1              | 1                                 | 405                              | 0.5                |
| SMF300A | SMF300CA | E30     | CE30 | 300              | 335                              | 371  | 1              | 1                                 | 486                              | 0.45               |
| SMF350A | SMF350CA | E35     | CE35 | 350              | 391                              | 432  | 1              | 1                                 | 567                              | 0.4                |
| SMF400A | SMF400CA | E40     | CE40 | 400              | 447                              | 494  | 1              | 1                                 | 648                              | 0.35               |
| SMF440A | SMF440CA | E44     | CE44 | 440              | 492                              | 543  | 1              | 1                                 | 713                              | 0.3                |



Fig.1 Peak Pulse Power Rating Curve

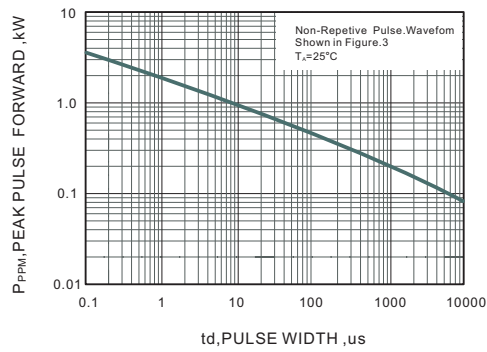

Fig.2 Forward Current Derating Curve

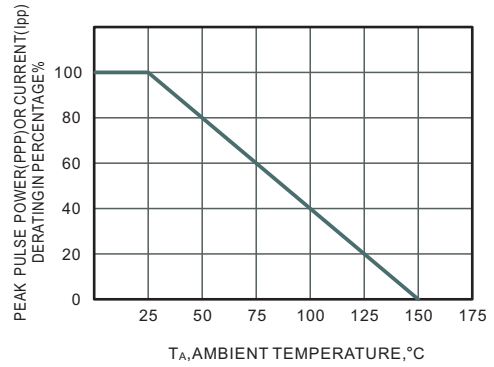

Fig.3 Pulse Waveform

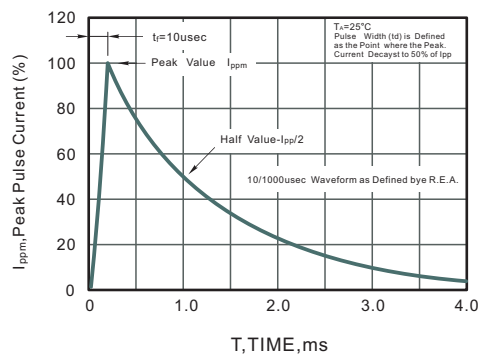
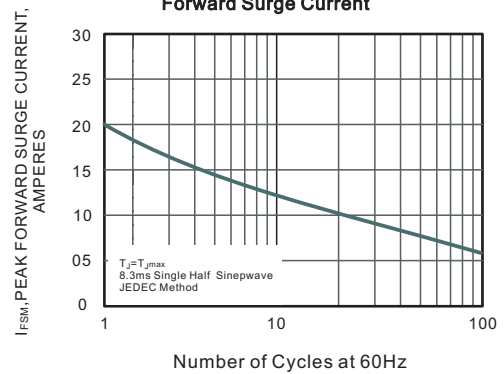

Fig.4 Maximum Non-Repetitive Peak Forward Surge Current





PACKAGE OUTLINE

Plastic surface mounted package; 2 leads

SOD-123FL

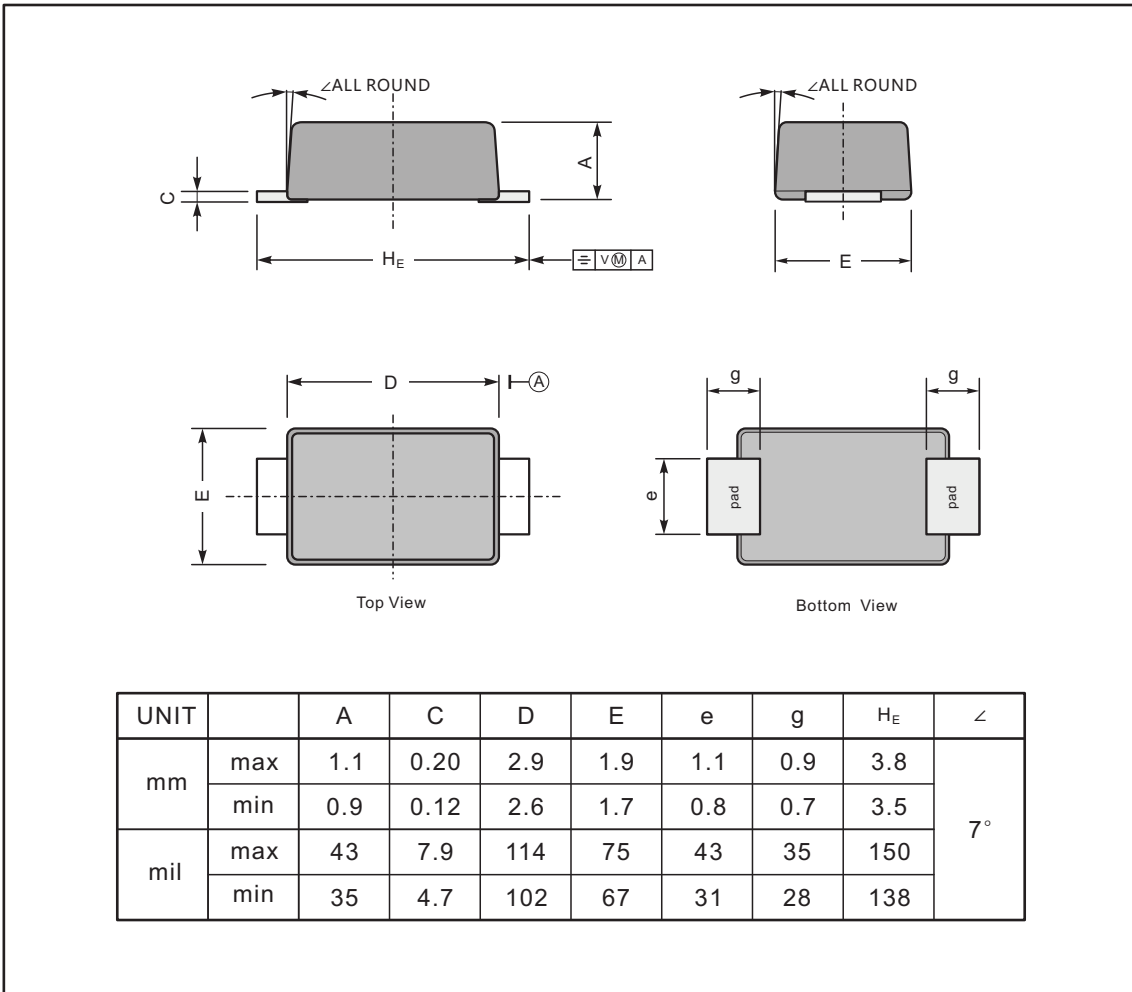

The recommended mounting pad size

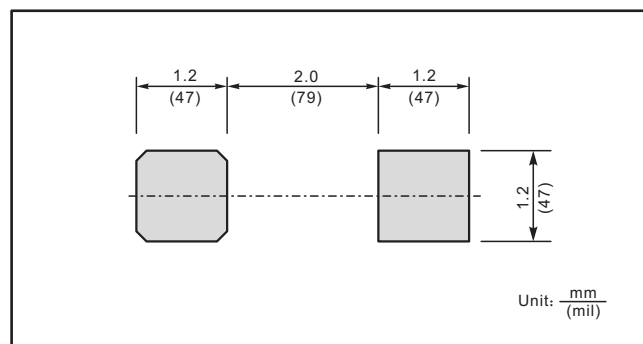

## X-ON Electronics

Largest Supplier of Electrical and Electronic Components

*Click to view similar products for [ESD Suppressors / TVS Diodes](#) category:*

*Click to view products by [Jingdao](#) manufacturer:*

Other Similar products are found below :

[60KS200C](#) [D18V0L1B2LP-7B](#) [D5V0F4U5P5-7](#) [DESD5V0U1BB-7](#) [NTE4902](#) [P4KE27CA](#) [P6KE11CA](#) [P6KE39CA-TP](#) [P6KE8.2A](#)  
[SA110CA](#) [SA60CA](#) [SA64CA](#) [SMBJ12CATR](#) [SMBJ33CATR](#) [SMBJ8.0A](#) [ESD101-B1-02ELS E6327](#) [ESD105-B1-02EL E6327](#) [ESD112-B1-02EL E6327](#) [ESD119B1W01005E6327XTSA1](#) [ESD5V0L1B02VH6327XTSA1](#) [ESD7451N2T5G](#) [19180-510](#) [CPDT-5V0USP-HF](#)  
[3.0SMCJ33CA-F](#) [3.0SMCJ36A-F](#) [HSPC16701B02TP](#) [D3V3Q1B2DLP3-7](#) [D55V0M1B2WS-7](#) [DESD5V0U1BL-7B](#) [DRTR5V0U4SL-7](#)  
[SCM1293A-04SO](#) [ESD200-B1-CSP0201 E6327](#) [SM12-7](#) [SMF8.0A-TP](#) [SMLJ45CA-TP](#) [SMQA1000T1G](#) [CEN955 W/DATA](#) [82350120560](#)  
[VESD12A1A-HD1-GS08](#) [CPDUR5V0R-HF](#) [CPDQC5V0U-HF](#) [CPDQC5V0USP-HF](#) [CPDQC5V0-HF](#) [IP4042CX5/LF,135](#) [D1213A-01LP4-7B](#) [D1213A-02WL-7](#) [1SMB33CAT3G-XYZ](#) [MMAD1108/TR13](#) [5KP100A](#) [5KP15A](#)