

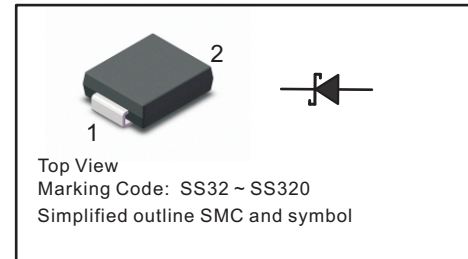

Surface Mount Schottky Barrier Rectifier  
Reverse Voltage - 20 to 200 V  
Forward Current - 3 A

PINNING

PIN	DESCRIPTION
1	Cathode
2	Anode



FEATURES

- Metal silicon junction, majority carrier conduction
- For surface mounted applications
- Low power loss, high efficiency
- High forward surge current capability
- For use in low voltage, high frequency inverters, free wheeling, and polarity protection applications

MECHANICAL DATA

- Case: SMC
- Terminals: Solderable per MIL-STD-750, Method 2026
- Approx. Weight: 0.22g / 0.0077oz

Maximum Ratings and Electrical characteristics

Ratings at 25 °C ambient temperature unless otherwise specified.

Single phase half-wave 60 Hz, resistive or inductive load, for capacitive load current derate by 20 %.

Parameter	Symbols	SS32C	SS34C	SS36C	SS38C	SS310C	SS312C	SS315C	SS320C	Units
Maximum Repetitive Peak Reverse Voltage	$V_{RRM}$	20	40	60	80	100	120	150	200	V
Maximum RMS voltage	$V_{RMS}$	14	28	42	56	70	84	105	140	V
Maximum DC Blocking Voltage	$V_{DC}$	20	40	60	80	100	120	150	200	V
Maximum Average Forward Rectified Current	$I_{F(AV)}$	3.0								A
Peak Forward Surge Current, 8.3ms Single Half Sine-wave Superimposed on Rated Load (JEDEC method)	$I_{FSM}$	80								A
Max Instantaneous Forward Voltage at 3 A	$V_F$	0.55	0.70		0.85		0.95			V
Maximum DC Reverse Current $T_a = 25^\circ\text{C}$ at Rated DC Reverse Voltage $T_a = 100^\circ\text{C}$	$I_R$	0.5 5			0.3 3					mA
Typical Junction Capacitance <sup>(1)</sup>	$C_j$	450			350					pF
Typical Thermal Resistance <sup>(2)</sup>	$R_{\theta JA}$	50								°C/W
Operating Junction Temperature Range	$T_j$	-55 ~ +150								°C
Storage Temperature Range	$T_{stg}$	-55 ~ +150								°C

(1) Measured at 1 MHz and applied reverse voltage of 4 V D.C

(2) P.C.B. mounted with 2.0" X 2.0" (5 X 5 cm) copper pad areas.



Fig.1 Forward Current Derating Curve

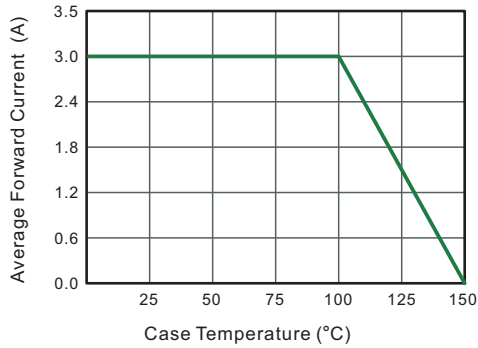

Fig.2 Typical Reverse Characteristics

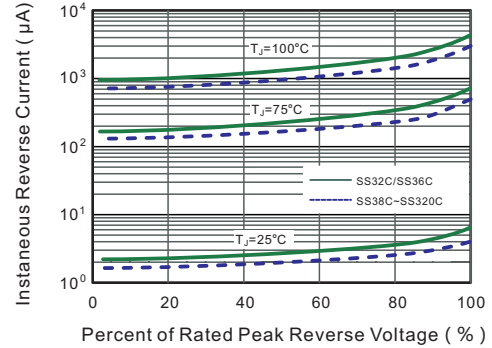

Fig.3 Typical Forward Characteristic

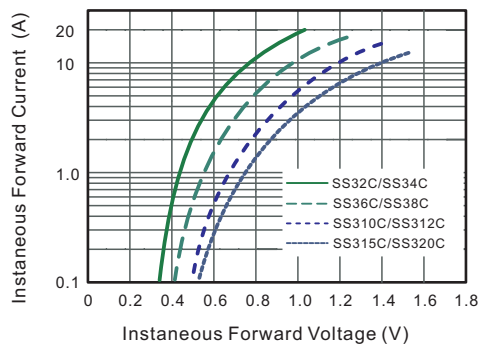

Fig.4 Typical Junction Capacitance

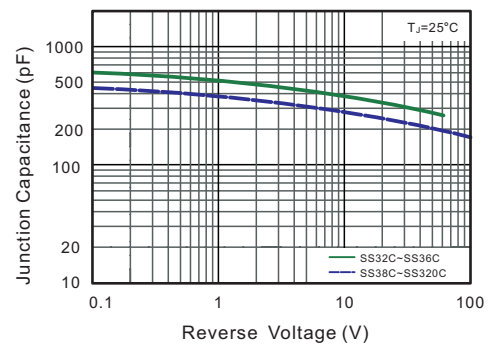

Fig.5 Maximum Non-Repetitive Peak Forward Surge Current

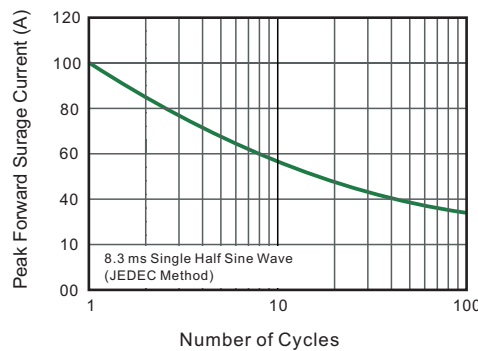
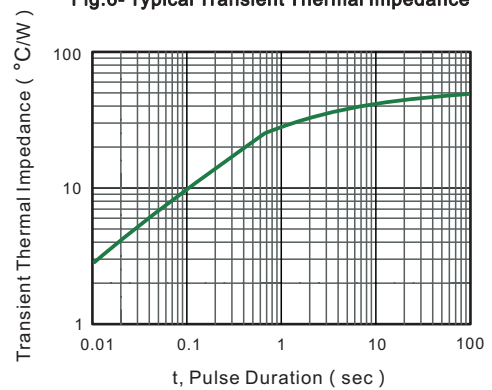

Fig.6- Typical Transient Thermal Impedance





**PACKAGE OUTLINE**

Plastic surface mounted package; 2 leads

SMC

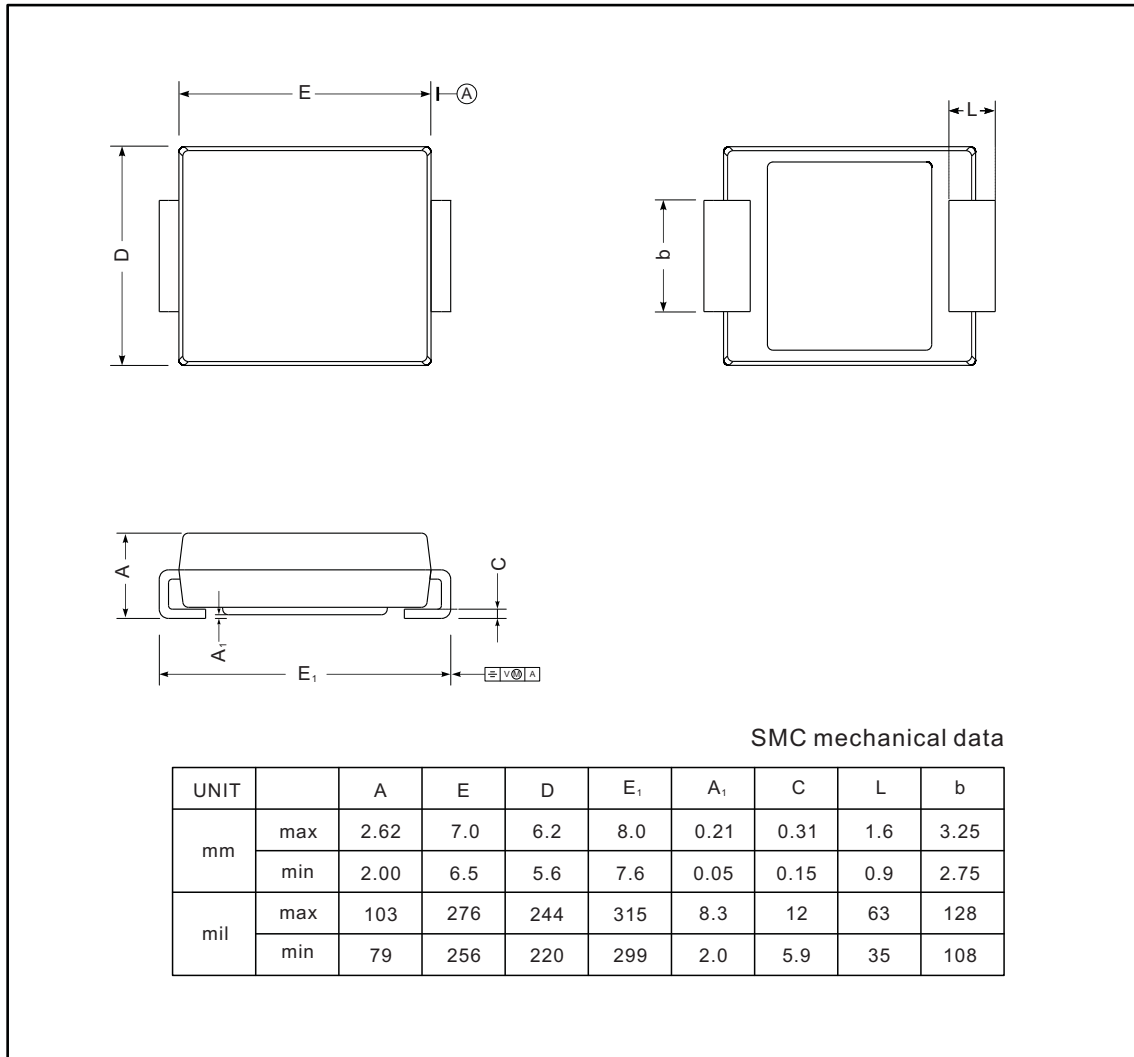

**The recommended mounting pad size**

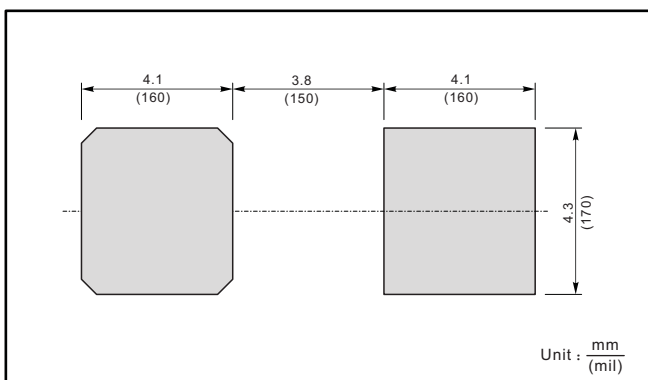

**Marking**

Type number	Marking code
SS32C	SS32
SS34C	SS34
SS36C	SS36
SS38C	SS38
SS310C	SS310
SS312C	SS312
SS315C	SS315
SS320C	SS320

## X-ON Electronics

Largest Supplier of Electrical and Electronic Components

*Click to view similar products for [Schottky Diodes & Rectifiers](#) category:*

*Click to view products by [Jingdao](#) manufacturer:*

Other Similar products are found below :

[CUS06\(TE85L,Q,M\)](#) [MA4E2039](#) [D1FH3-5063](#) [MBR0530L-TP](#) [MBR10100CT-BP](#) [MBR30H100MFST1G](#) [MMBD301M3T5G](#) [PMAD1103-LF](#) [PMAD1108-LF](#) [RB160M-50TR](#) [RB520S-30](#) [RB551V-30](#) [DD350N18K](#) [DZ435N40K](#) [DZ600N16K](#) [BAS16E6433HTMA1](#) [BAS 3010S-02LRH E6327](#) [BAT 54-02LRH E6327](#) [IDL02G65C5XUMA1](#) [NSR05F40QNXT5G](#) [NSVR05F40NXT5G](#) [JANS1N6640](#) [SB07-03C-TB-H](#) [SB1003M3-TL-W](#) [SBAT54CWT1G](#) [SBM30-03-TR-E](#) [SBS818-TL-E](#) [SK32A-LTP](#) [SK33A-TP](#) [SK34A-TP](#) [SK34B-TP](#) [SMD1200PL-TP](#) [ACDBN160-HF](#) [SS3003CH-TL-E](#) [STPS30S45CW](#) [PDS3100Q-7](#) [GA01SHT18](#) [CRS10I30A\(TE85L,QM\)](#) [MBR1240MFST1G](#) [MBRB30H30CT-1G](#) [BAS28E6433HTMA1](#) [BAS 70-02L E6327](#) [HSB123JTR-E](#) [JANTX1N5712-1](#) [VS-STPS40L45CW-N3](#) [DD350N12K](#) [SB007-03C-TB-E](#) [SB10015M-TL-E](#) [SB1003M3-TL-E](#) [SK110-LTP](#)