

Surface Mount Schottky Barrier Rectifier
Reverse Voltage - 20 to 200V
Forward Current - 5.0A

FEATURES

- Metal silicon junction, majority carrier conduction
- For surface mounted applications
- Low power loss, high efficiency
- High forward surge current capability
- For use in low voltage, high frequency inverters, free wheeling, and polarity protection applications

MECHANICAL DATA

- Case: SMBF
- Terminals: Solderable per MIL-STD-750, Method 2026
- Approx. Weight: 57mg / 0.002oz

PINNING

PIN	DESCRIPTION
1	Cathode
2	Anode

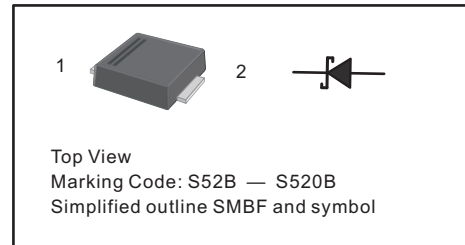

Absolute Maximum Ratings and Electrical characteristics

Ratings at 25 °C ambient temperature unless otherwise specified. Single phase, half wave, 60Hz resistive or inductive load, for capacitive load, derate by 20 %

Parameter	Symbols	SS52BF	SS54BF	SS56BF	SS58BF	SS510BF	SS512BF	SS515BF	SS520BF	Units	
Maximum Repetitive Peak Reverse Voltage	V_{RRM}	20	40	60	80	100	120	150	200	V	
Maximum RMS voltage	V_{RMS}	14	28	42	56	70	84	105	140	V	
Maximum DC Blocking Voltage	V_{DC}	20	40	60	80	100	120	150	200	V	
Maximum Average Forward Rectified Current	$I_{F(AV)}$	5.0								A	
Peak Forward Surge Current, 8.3ms Single Half Sine-wave Superimposed on Rated Load (JEDEC method)	I_{FSM}	150								A	
Max Instantaneous Forward Voltage at 5 A	V_F	0.55	0.70		0.85				V		
Maximum DC Reverse Current $T_a = 25^\circ\text{C}$ at Rated DC Reverse Voltage $T_a = 100^\circ\text{C}$	I_R	1.0					50				mA
Typical Junction Capacitance ⁽¹⁾	C_j	800	500						pF		
Typical Thermal Resistance ⁽²⁾	$R_{\theta JA}$	45								°C/W	
Operating Junction Temperature Range	T_j	-55 ~ +150								°C	
Storage Temperature Range	T_{stg}	-55 ~ +150								°C	

(1) Measured at 1 MHz and applied reverse voltage of 4 V D.C

(2) P.C.B. mounted with 2.0" X 2.0" (5 X 5 cm) copper pad areas.



Fig.1 Forward Current Derating Curve

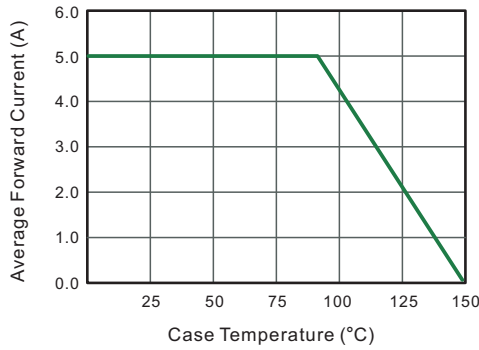

Fig.2 Typical Reverse Characteristics

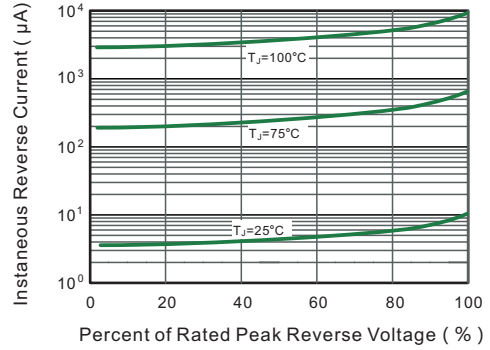

Fig.3 Typical Forward Characteristic

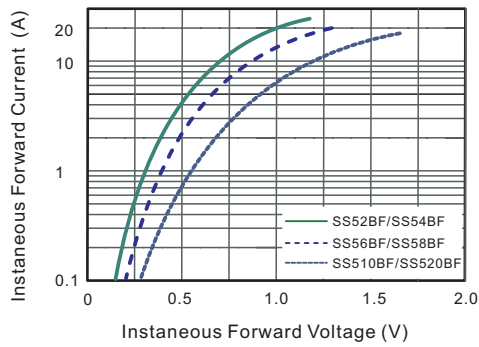

Fig.4 Typical Junction Capacitance

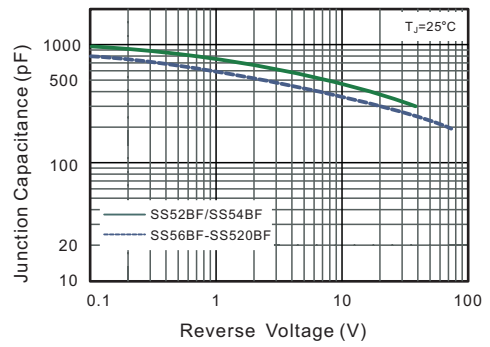

Fig.5 Maximum Non-Repetitive Peak Forward Surge Current

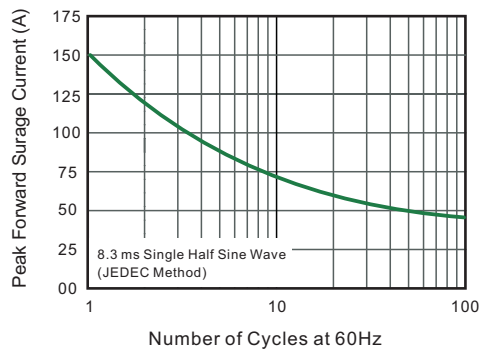
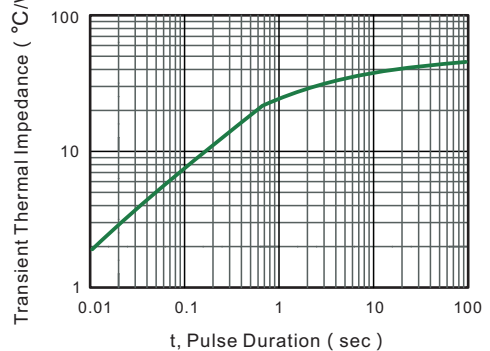

Fig.6- Typical Transient Thermal Impedance





PACKAGE OUTLINE

Plastic surface mounted package; 2 leads

SMBF

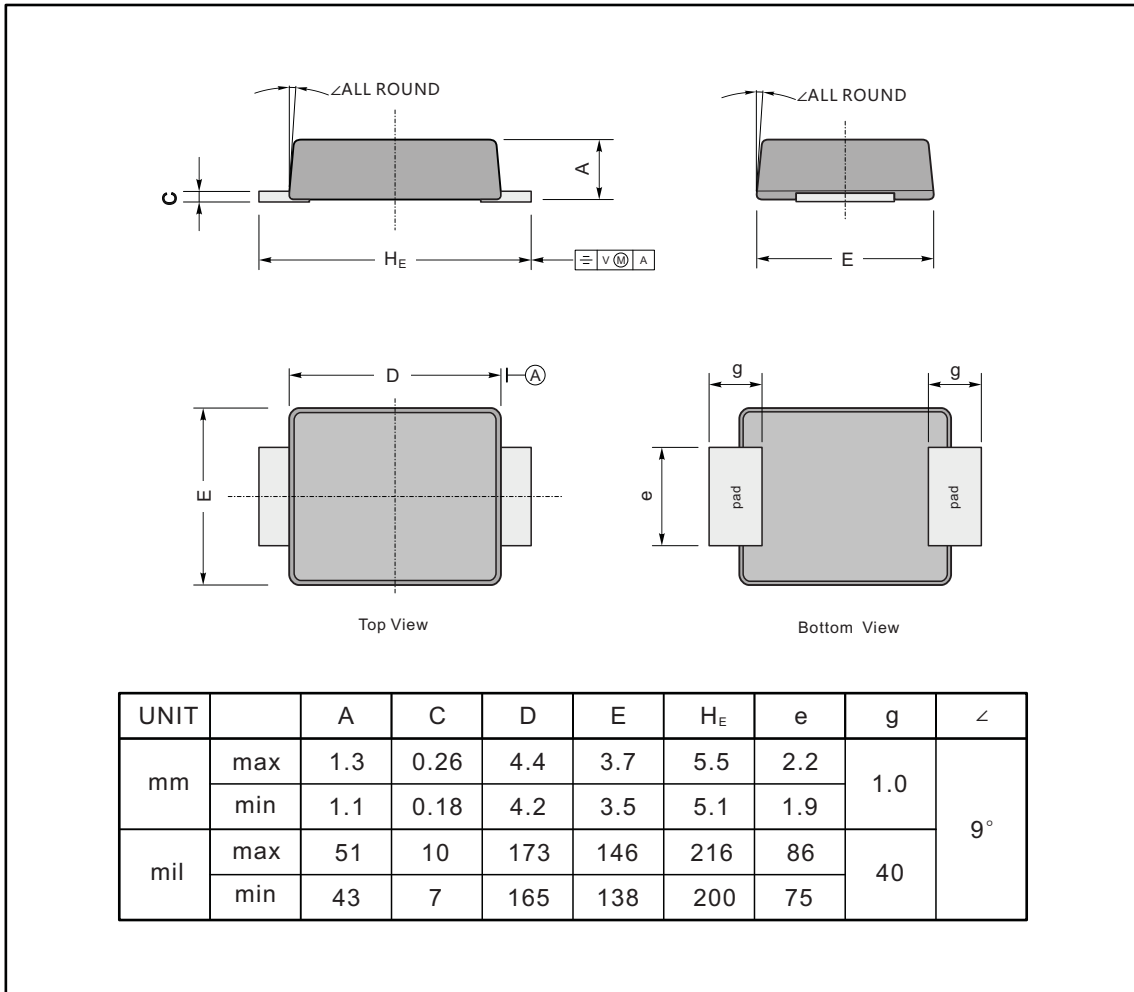

The recommended mounting pad size

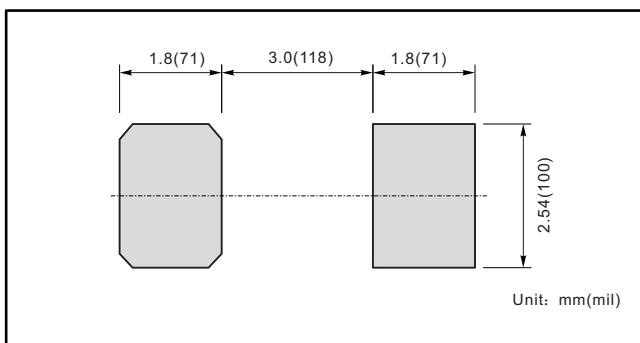

Marking

Type number	Marking code
SS52BF	S52B
SS54BF	S54B
SS56BF	S56B
SS58BF	S58B
SS510BF	S510B
SS512BF	S512B
SS515BF	S515B
SS520BF	S520B

X-ON Electronics

Largest Supplier of Electrical and Electronic Components

Click to view similar products for [Schottky Diodes & Rectifiers](#) category:

Click to view products by [Jingdao](#) manufacturer:

Other Similar products are found below :

[MA4E2039](#) [MA4E2508M-1112](#) [MBR10100CT-BP](#) [MBR1545CT](#) [MMBD301M3T5G](#) [GS1JE-TP](#) [RB160M-50TR](#) [BAS 3010S-02LRH E6327](#)
[BAT 54-02LRH E6327](#) [NSR05F40QNXT5G](#) [NSVR05F40NXT5G](#) [NTE555](#) [JANS1N6640](#) [SB07-03C-TB-H](#) [SBAT54CWT1G](#) [SK310-T](#)
[SK33A-TP](#) [SK34B-TP](#) [SS3003CH-TL-E](#) [PDS3100Q-7](#) [GA01SHT18](#) [CRS10I30A\(TE85L,QM](#) [MA4E2501L-1290](#) [MBRB30H30CT-1G](#)
[BAS 70-02L E6327](#) [DMJ3940-000](#) [SB007-03C-TB-E](#) [SK32A-TP](#) [SK33B-TP](#) [SK35A-TP](#) [SK38B-LTP](#) [SK38B-TP](#) [NTE505](#)
[NTSB30U100CT-1G](#) [VS-6CWQ10FNHM3](#) [CRG04\(T5L,TEMQ\)](#) [ACDBA1100LR-HF](#) [ACDBA1200-HF](#) [ACDBA140-HF](#) [ACDBA2100-HF](#)
[ACDBA240-HF](#) [ACDBA3100-HF](#) [CDBQC0530L-HF](#) [BAT54-13-F](#) [ACDBA340-HF](#) [ACDBA260LR-HF](#) [ACDBA1100-HF](#) [MA4E2502L-](#)
[1246](#) [10BQ060-M3/5BT](#) [10BQ040-M3/5BT](#)