

## FEATURES

- Plastic package has Underwriters Laboratory Flammability Classification 94V-0
- Metal silicon junction ,majority carrier conduction
- Guard ring for overvoltage protection
- Low power loss ,high efficiency
- High current capability ,Low forward voltage drop
- High surge capability
- For use in low voltage ,high frequency inverters, free wheeling ,and polarity protection applications
- Dual rectifier construction
- High temperature soldering guaranteed:260 °C/10 seconds, 0.25"(6.35mm)from case
- Component in accordance to RoHS 2002/95/EC and WEEE 2002/96/EC

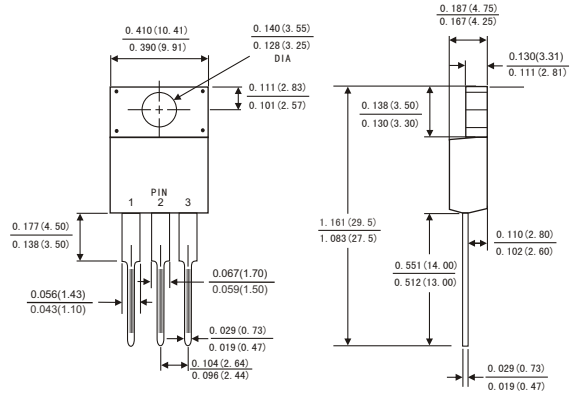

## ITO-220AB



## MECHANICAL DATA

- Case: JEDEC ITO-220AB molded plastic body
- Terminals: Lead solderable per MIL-STD-750,method 2026
- Polarity: As marked.
- Mounting Position: Any
- Weight: 0.08ounce, 2.24 gram

Dimensions in inches and (millimeters)

## MAXIMUM RATINGS AND ELECTRICAL CHARACTERISTICS

(Ratings at 25°C ambient temperature unless otherwise specified ,Single phase ,half wave ,resistive or inductive load. For capacitive load,derate by 20%.)

|  | Symbols                | SRF 1020CT  | SRF 1030CT | SRF 1040CT | SRF 1050CT | SRF 1060CT | SRF 1080CT | SRF 10100CT | SRF 10150CT | SRF 10200CT | Units |
|--|------------------------|-------------|------------|------------|------------|------------|------------|-------------|-------------|-------------|-------|
| Maximum repetitive peak reverse voltage  | V <sub>RRM</sub>       | 20          | 30         | 40         | 50         | 60         | 80         | 100         | 150         | 200         | Volts |
| Maximum RMS voltage  | V <sub>RMS</sub>       | 14          | 21         | 28         | 35         | 42         | 56         | 70          | 105         | 140         | Volts |
| Maximum DC blocking voltage  | V <sub>DC</sub>        | 20          | 30         | 40         | 50         | 60         | 80         | 100         | 150         | 200         | Volts |
| Maximum average forward rectified current(see Fig.1)   | Per leg                | 5.0         |            |            |            |            |            |             |             |             | Amps  |
|  | Total device           | 10.0        |            |            |            |            |            |             |             |             |       |
| Peak forward surge current 8.3ms single half sine-wave superimposed on rated load (JEDEC method) | I <sub>FSM</sub>       | 150         |            |            |            |            |            |             |             |             | Amps  |
| Maximum instantaneous forward voltage at 10.0 A(Note 1)  | V <sub>F</sub>         | 0.60        |            |            | 0.75       |            | 0.85       |             | 0.90        | 0.95        | Volts |
| Maximum instantaneous reverse current at rated DC blocking voltage(Note 1)                       | T <sub>a</sub> = 25°C  | 0.2         |            |            |            |            |            |             |             |             | mA    |
|  | T <sub>a</sub> = 125°C | 15          |            |            | 50         |            |            |             |             |             |       |
| Typical thermal resistance (Note 2)  | R <sub>θJC</sub>       | 2.5         |            |            |            |            |            |             |             |             | °C/W  |
| Operating junction temperature range   | T <sub>J</sub>         | -65 to +150 |            |            |            |            |            |             |             |             | °C    |
| Storage temperature range  | T <sub>STG</sub>       | -65 to +150 |            |            |            |            |            |             |             |             | °C    |

- Notes: 1.Pulse test: 300 μs pulse width,1% duty cycle  
2.Thermal resistance from junction to case

# RATINGS AND CHARACTERISTIC CURVES SRF1020CT THRU SRF10200CT

FIG.1-FORWARD CURRENT DERATING CURVE

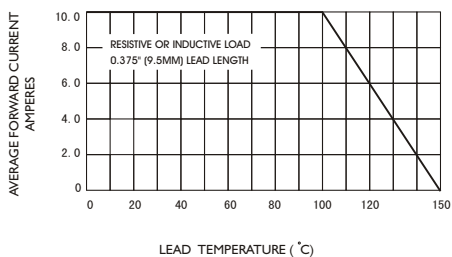

FIG.2-MAXIMUM NON-REPETITIVE PEAK FORWARD SURGE CURRENT

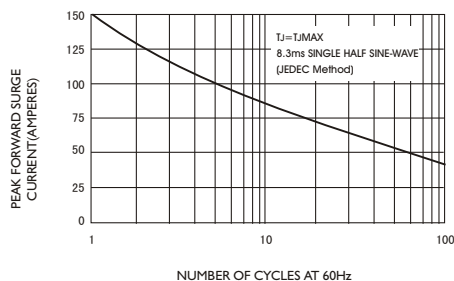

FIG.3-TYPICAL INSTANTANEOUS FORWARD CHARACTERISTICS

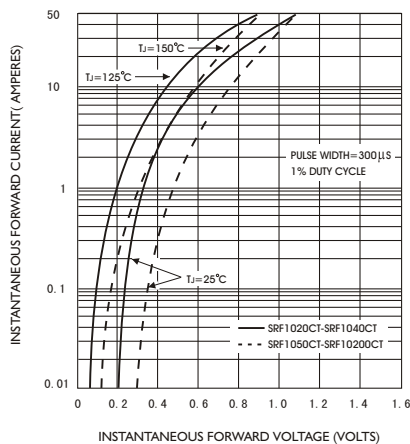

FIG.4-TYPICAL REVERSE CHARACTERISTICS

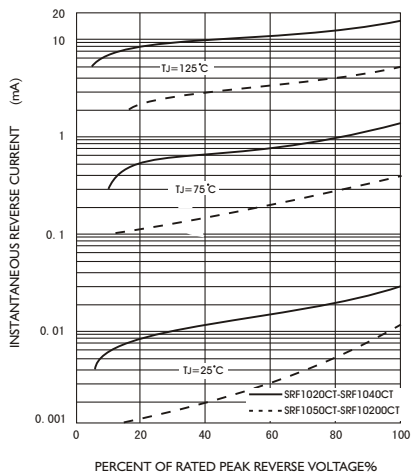

FIG.5-TYPICAL JUNCTION CAPACITANCE

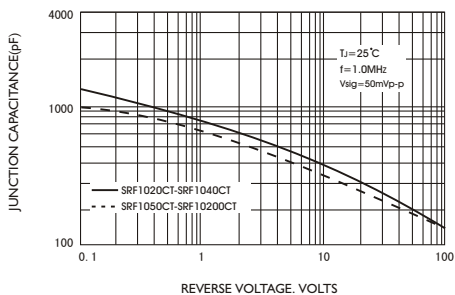
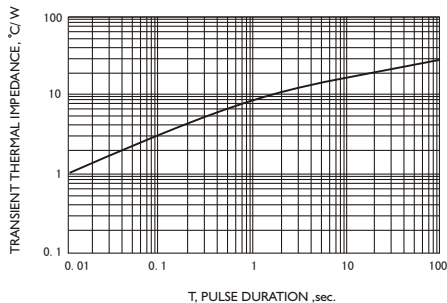

FIG.6-TYPICAL TRANSIENT THERMAL IMPEDANCE



## X-ON Electronics

Largest Supplier of Electrical and Electronic Components

*Click to view similar products for [Schottky Diodes & Rectifiers](#) category:*

*Click to view products by [Jing Heng](#) manufacturer:*

Other Similar products are found below :

[CUS06\(TE85L,Q,M\)](#) [MA4E2039](#) [D1FH3-5063](#) [MBR0530L-TP](#) [MBR10100CT-BP](#) [MBR30H100MFST1G](#) [MMBD301M3T5G](#) [PMAD1103-LF](#) [PMAD1108-LF](#) [RB160M-50TR](#) [RB520S-30](#) [RB551V-30](#) [DD350N18K](#) [DZ435N40K](#) [DZ600N16K](#) [BAS16E6433HTMA1](#) [BAS 3010S-02LRH E6327](#) [BAT 54-02LRH E6327](#) [IDL02G65C5XUMA1](#) [NSR05F40QNXT5G](#) [NSVR05F40NXT5G](#) [JANS1N6640](#) [SB07-03C-TB-H](#) [SB1003M3-TL-W](#) [SBAT54CWT1G](#) [SBM30-03-TR-E](#) [SBS818-TL-E](#) [SK32A-LTP](#) [SK33A-TP](#) [SK34A-TP](#) [SK34B-TP](#) [SMD1200PL-TP](#) [ACDBN160-HF](#) [SS3003CH-TL-E](#) [STPS30S45CW](#) [PDS3100Q-7](#) [GA01SHT18](#) [CRS10I30A\(TE85L,QM\)](#) [MBR1240MFST1G](#) [MBRB30H30CT-1G](#) [BAS28E6433HTMA1](#) [BAS 70-02L E6327](#) [HSB123JTR-E](#) [JANTX1N5712-1](#) [VS-STPS40L45CW-N3](#) [DD350N12K](#) [SB007-03C-TB-E](#) [SB10015M-TL-E](#) [SB1003M3-TL-E](#) [SK110-LTP](#)