

变更单号	版本号	变更日期	内容描述	变更	审核	批准	未注公差
	A/0						$\pm 0.25$
	A/1	20131015	按实际电键由镀锡改为镀	胡正特	宋于静	管奎	$>10\sim 30$
							$>30\sim$
							$\pm 5^\circ$

### 外形图

### CK3.5插座

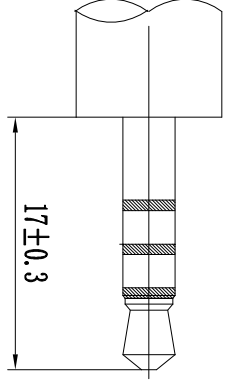
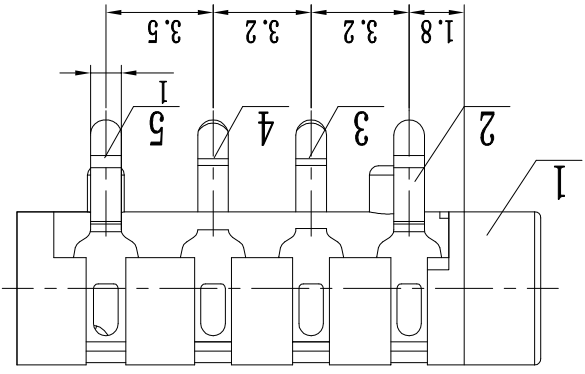
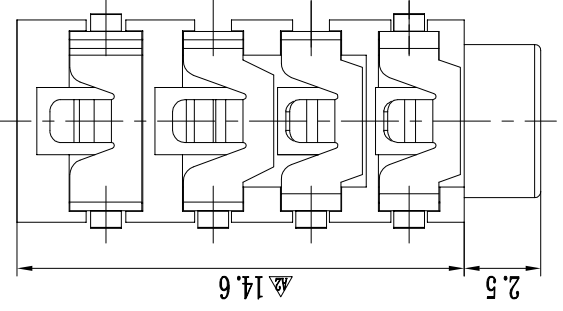
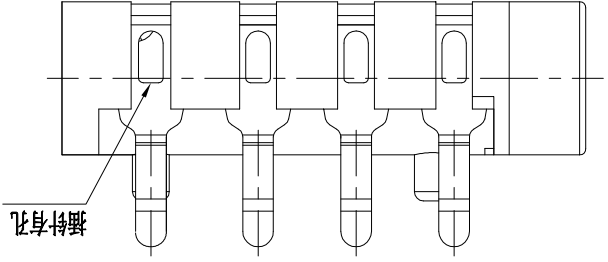

配套插头

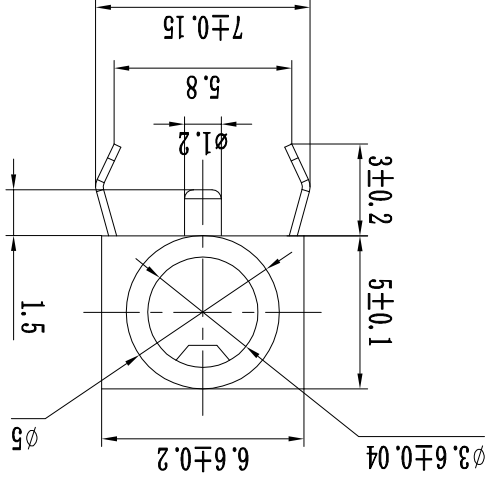

设计	日期	名称	产品
胡正特	2019.3.1	CK3.5插座	CK3.5插座
审核	日期	料号	产品
郑旭东	2019.3.1	CK3.5-28-5	CK3.5-28-5
批准	日期	比例	单位
叶贻州	2019.3.1	4:1	mm

深圳金佳润电子科技有限公司  
Shenzhen JinJiarun Electronics Technology Co., Ltd

序号	零件料号	名称	材料	数量	镀层/颜色	备注
1	C321-0028+B	塑座	PA66 阻燃	1	黑色	※
2	C313-2801+G	1号插针	QSn6.5-0.1Y t=0.25	1	Ag	※
3	C313-2802+G	2号插针	QSn6.5-0.1Y t=0.25	1	Ag	※
4	C313-2803+G	3号插针	镀铜C12 t=0.25	1	Ag	※
5	C313-2804+G	4号插针	QSn6.5-0.1Y t=0.25	1	Ag	※

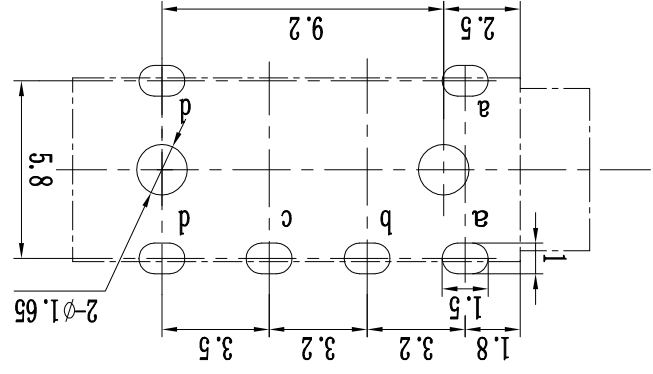

PCB LAYOUT(TOP VIEW)  
(tolerance±0.05)

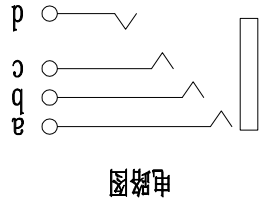

Item	Property	Test condition	Performance
4-1	Withstand Voltage	Withstand AC 500V (50/60Hz RMS) between two non-contact terminals for 1 minute	No dielectric breakd own shall occur. 无击穿现象发生
4-2	Insulation Resistance	Apply 500V DC between any contactless terminal and the other terminal, with an insulation gauge and last for 1 minute ± 5 seconds.	100 MΩ Min. 最小100 兆欧
	绝緣阻抗	在任何一個不接觸的端子與另一個端子之間施加500V直流電，用絕緣測量儀，並能持續1分鐘±5秒。	

4. Electrical efficiency / 电气特性

3. Construction / 说明

3-1. Outline And Dimension / 外观和尺寸  
The appearance and dimensions of the socket should match the attachment drawing.  
插座的外观和尺寸应与附件图纸相符。

3-2. Part And Material 部件和材料  
Parts and materials should be consistent with the material list specifications.  
部件和材料应与材料清单规格一致。

2-2. Preservation temperature range: -10℃ to +40℃  
保存温度范围: -10℃ 至 +40℃  
Humidity range: 85% RH. MAX.  
湿度范围: 85% RH. MAX.

2-3. Rated voltage and current (MAX.): 30V DC , 0.5A  
最大额定电压和额定电流: 30V DC , 0.5A

2-4. Appearance : No scratches, soil, rust or discoloration on the surface.  
外观: 表面无划伤、脏污、生锈或变色等现象。

5. Mechanical Performance 机械特性

Item	Property	Test condition	Performance
5-1	插入力&拔出力 Insertion and Extraction Force	Plug and unplug with a matching plug at a frequency of 20-30 times per minute. 用相匹配的插头以每分钟 20-30 次的频率均速插头进行插拔。	Insertion and extraction force is 0.3 ~ 3kgf 插入和拔出力的值为 0.3 ~ 3kgf.
5-2	端子强度 Terminal Strength	Every terminal should be capable of withstand a force of 0.5 kgf for 10 seconds. 每个端子都应能承受 0.5 kgf 的力, 并持续 10 秒。	There is no looseness, damage, etc., but the terminal deformation is acceptable. 无松脱、破损等现象, 但是端子变形可以接 受。
6-1	寿命试验 Life test	Under the condition of no load, plug and unplug with a matching plug for 500 times in total, at a frequency of 20-30 times per minute. 在没有负载的条件下, 以每分钟 20-30 次的频率, 均速, 用相匹配的插头进行插拔 5000 次。	No obvious change in appearance, destruction, Contact resistance: less than 30 mΩ. The insertion and extraction force values : 0.3 to 3 kgf. 外观无明显改变, 破坏. 接触电阻: 小于 30 毫欧. 插入和拔出力的值为 0.3 ~ 3kgf.

6. Durability / 耐久性能

7-1	耐焊性 soldering heat	端子浸入锡炉里，按以下条件测试： 焊锡温度：260°C±3°C。 浸入时间：5±1 秒。	not fall off the plastic base. 试验后塑胶基座不应变形，端子不从塑胶基座上脱落下来
7-2	可焊性 Solderability	Temperature of solder: 245±3° C. Time of dip: 3±0.5 seconds. 焊锡温度：245±3° C。 浸入时间：3±0.5 秒	Coating of solder area should be more than 95% 焊锡面积要求达到95%以上

8. Environment test / 环境试验

Item	Property	Test condition	Performance 判定
8-1	低温测试 Cold test	Place the housing for 96 hours at a low temperature of -25 ± 3 ° C. Then, place it under standard atmospheric conditions for 1 hour and test. 在-25±3°C低温条件下将基座放置96小时，然后在标准大气条件下放置1小时，然后再测试。	No obvious change in appearance Contact resistance:10 OmΩ max。 Insulation resistance: 100 MΩ min。 Withstand voltage:AC 500V。
8-2	高温测试 Heat test	The housing should be stored at a temperature of 85±2°C for 96 hours. Then it should be subjected to standard atmospheric conditions for 1 hour and test. 在85±2°C高温条件下将基座放置96小时，然后在标准大气条件下放置1小时，然后再测试。	外观没有明显的改变。 接触电阻：小于100毫欧。 绝缘阻抗：大于100兆欧。 耐压： AC 500V。

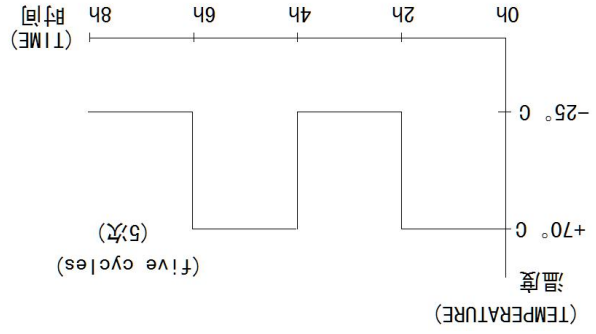
<p>Insulation resistance: 100 MΩ min. Withstand voltage: AC 500V. 外观没有明显的改变。接触电阻: 小于 100 毫欧。绝缘阻抗: 大于 100 兆欧。耐电压: AC 500V。</p>	<p>should be subjected to standard atmospheric conditions for 1 hour and test 在温度为 <math>40 \pm 3^{\circ}\text{C}</math>, 相对湿度为 90%~95% 条件下, 将底座放置 96 小时, 再在标准大气条件下放置 1 小时, 然后再测试。</p>	<p>Humidity test 耐湿试验</p>	<p>8-3</p>
	<p>Place the Jack under the conditions shown below and then place it in the stand at room temperature for 30 minutes. 将插座放置于如下所示条件下进行试验, 然后在室温条件下放置 30 分钟。</p>  <p>温度 (TEMPERATURE) +70° C -25° C 0h 2h 4h 6h 8h (TIME) (five cycles) (5次)</p>	<p>Temperature Cycling 温度循环</p>	<p>8-4</p>

9. Test condition / 测试条件

Unless otherwise specified, the test and measurement temperature is between 15 ° C and 35 ° C, the relative humidity is between 25% and 85%, and the atmospheric pressure is between 86 kPa and 106 kPa.

However, when any doubts arise on the judgment value under the above condition, the test and measurement are carried out at  $20 \pm 1$  ° C, the relative humidity is 63% to 67%, and the air pressure is performed at 86 kPa to 106 kPa.  
除非另有指定, 否则测试和测量温度在 15 ° C~35 ° C, 相对湿度在 25%~85%, 气压在 86kPa~106kPa 条件下进行。  
当在这个条件下判定出现疑问时, 测试和测量在  $20 \pm 1$  ° C, 相对湿度 63%~67%, 气压在 86kPa~106kPa 条件下进行。

10. Amendment / 变更修正

When it is necessary to amend the specifications, it should be negotiated and agreed by the manufacturer and the customer before proceeding.  
当有必要对规格书进行变更修正时, 应该在制造商和客户共同商议及同意后才可以进行。

※ Specifications are recorded in both English and Chinese, but Chinese is preferred in the case of doubts.  
规格书同时记入中英文，但发生疑义的场所以中文优先。

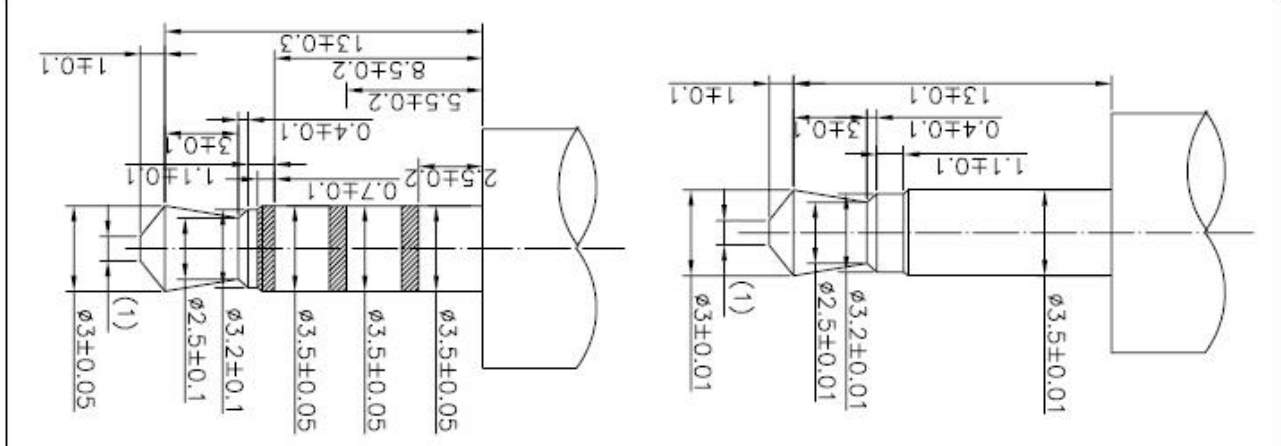

4 CONDUCTORS TYPE

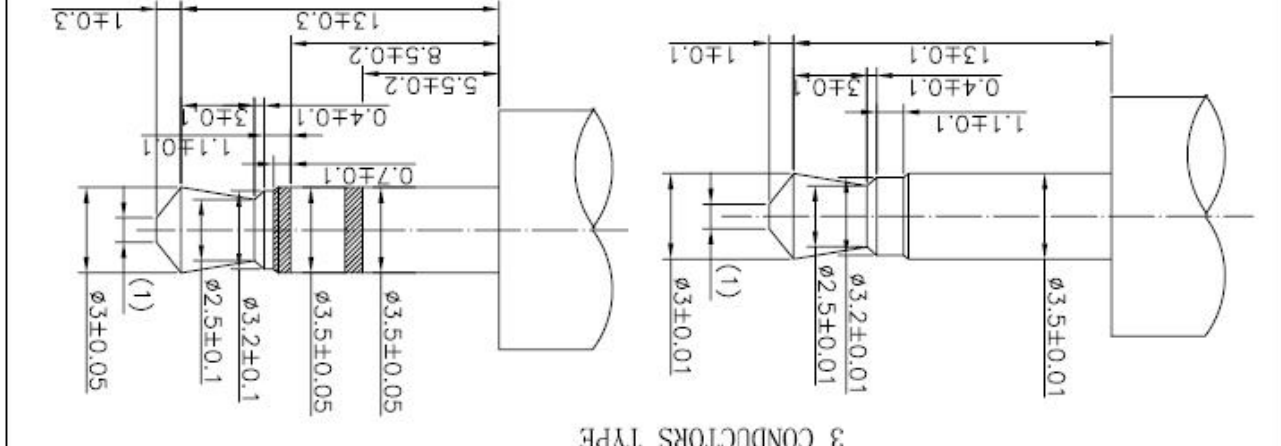

3 CONDUCTORS TYPE

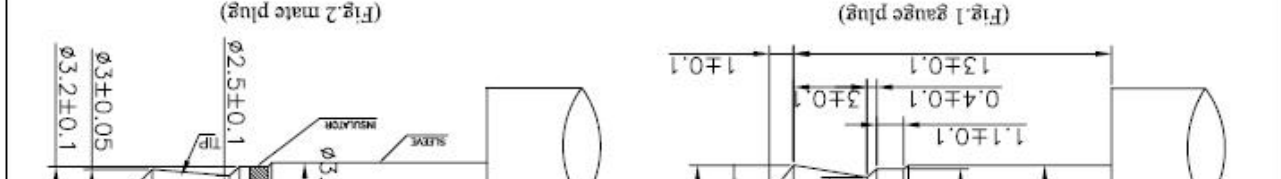

(Fig. 2 mate plug)



JINJIARUN Electronics Technology Co., Ltd.



## X-ON Electronics

Largest Supplier of Electrical and Electronic Components

*Click to view similar products for [HDMI, Displayport & DVI Connectors](#) category:*

*Click to view products by [JINJIA](#) manufacturer:*

Other Similar products are found below :

[1775247-3](#) [2-1932649-5](#) [30-1231](#) [30-528](#) [2069485-1](#) [30-504](#) [30-519](#) [30-542](#) [47648-2000](#) [2002-400](#) [TC142X](#) [1453G1](#) [769-103/021-000](#)  
[1932649-1](#) [233-368NFG6-17NH](#) [G45A19071083HR](#) [233-360NF00-17NH](#) [CP30200GM3B](#) [HYC02-DVI29-371](#) [P136-06NHDV4KBP](#)  
[CP30116](#) [LTWDID-29PFFS-SL8001](#) [46765-1301](#) [1211-0010-201-001](#) [47271-1004](#) [32-1121-BU](#) [DS1117-BN0-TME-002](#) [MHDR2A11004BP](#)  
[EHHDMI2PKG](#) [1903015-3](#) [DS1114-BN0](#) [WPUSBAF](#) [500254-1931](#) [HDMR-19-01-F-SM](#) [47151-1071](#) [1747981-1](#) [0480372000](#) [0482580001](#)  
[D121073-19](#) [472710111](#) [HDMI-S-RA6-SMT-MF-15](#) [P142-000-UP](#) [P134-003](#) [P120-08N](#) [KDMIX-FS1V-WS-B](#) [P142-000-UD](#) [10029449-](#)  
[101RLF](#) [P132-000](#) [P130-000](#) [P142-06N-MICRO](#)