

Performance Specification

Model	V _{max} (V dc)	I _{max} (A)	I _{hold} @25°C (A)	I _{trip} @25°C (A)	P _d Typ. (W)	Maximum Time To Trip		Resistance	
						Current (A)	Time (Sec)	R _{i min} (Ω)	R _{1max} (Ω)
JSMD0805-075L/12	12.0	50.0	0.75	1.5	1.2	8.0	1.0	0.02	0.16
JSMD0805-110L	6.0	50.0	1.1	2.2	1.2	8.0	1.0	0.018	0.11
JSMD0805-110L/12	12.0	50.0	1.1	2.2	1.2	8.0	1.0	0.018	0.11
JSMD0805-125L	6.0	50.0	1.25	2.5	1.2	8.0	1.0	0.016	0.1
JSMD0805-125L/12	12.0	50.0	1.25	2.5	1.2	8.0	1.0	0.016	0.1
JSMD0805-150L	6.0	50.0	1.5	3.0	1.2	8.0	1.0	0.008	0.065
JSMD0805-150L/12	12.0	50.0	1.5	3.0	1.2	8.0	1.0	0.008	0.065
JSMD0805-175L	6.0	50.0	1.75	3.5	1.2	8.0	5.0	0.007	0.055
JSMD0805-175L/12	12.0	50.0	1.75	3.5	1.2	8.0	5.0	0.007	0.055
JSMD0805-200L	6.0	50.0	2.0	4.0	1.2	8.0	5.0	0.006	0.045
JSMD0805-200L/12	12.0	50.0	2.0	4.0	1.2	8.0	5.0	0.006	0.045
JSMD0805-260L	6.0	50.0	2.6	5.2	1.2	8.0	5.0	0.005	0.035
JSMD0805-260L/12	12.0	50.0	2.6	5.2	1.2	8.0	5.0	0.005	0.035
JSMD0805-300L	6.0	50.0	3.0	6.0	1.2	8.0	5.0	0.004	0.03
JSMD0805-300L/12	12.0	50.0	3.0	6.0	1.2	8.0	5.0	0.004	0.03
JSMD0805-350L	6.0	50.0	3.5	7.0	1.2	8.0	5.0	0.003	0.025
JSMD0805-350L/12	12.0	50.0	3.5	7.0	1.2	8.0	5.0	0.003	0.025
JSMD0805-380L	6.0	50.0	3.8	7.6	1.2	19.0	2.0	0.002	0.02
JSMD0805-380L/12	12.0	50.0	3.8	7.6	1.2	19.0	2.0	0.002	0.02
JSMD0805-400L	6.0	50.0	4.0	8.0	1.2	20.0	2.0	0.001	0.015
JSMD0805-400L/12	12.0	50.0	4.0	8.0	1.2	20.0	2.0	0.001	0.015

V_{max} = Maximum operating voltage device can withstand without damage at rated current (I_{max}).

I_{max} = Maximum fault current device can withstand without damage at rated voltage (V_{max}).

I_{hold} = Hold Current. Maximum current device will not trip in 25°C still air.

I_{trip} = Trip Current. Minimum current at which the device will always trip in 25°C still air.

P_d = Power dissipation when device is in the tripped state in 25°C still air environment at rated voltage.

R_{i min/max} = Minimum/Maximum device resistance prior to tripping at 25°C.

R_{1max} = Maximum device resistance is measured one hour post reflow.

CAUTION : Operation beyond the specified ratings may result in damage and possible arcing and flame.



Environmental Specifications

Test	Conditions	Resistance change
Passive aging	+85°C, 1000 hrs.	±5% typical
Humidity aging	+85°C, 85% R.H. , 168 hours	±5% typical
Thermal shock	+85°C to -40°C, 20 times	±33% typical
Resistance to solvent	MIL-STD-202,Method 215	No change
Vibration	MIL-STD-202,Method 201	No change

Ambient operating conditions : - 40 °C to +85 °C

Maximum surface temperature of the device in the tripped state is 125 °C

Agency Approval and Environmental Compliance

Agency	File Number	Regulation	Standard
UL	E217453		2011/65/EU
TUV	pending		EN14582

Thermal Derating Chart

Recommended Hold Current(A) at Ambient Temperature(°C)

Model	Ambient Operation Temperature								
	-40°C	-20°C	0°C	25°C	40°C	50°C	60°C	70°C	85°C
JSMD0805-075L/12	1.07	0.94	0.88	0.75	0.66	0.63	0.6	0.48	0.34
JSMD0805-110L	1.57	1.38	1.29	1.1	0.98	0.92	0.88	0.71	0.5
JSMD0805-110L/12	1.57	1.38	1.29	1.1	0.98	0.92	0.88	0.71	0.5
JSMD0805-125L	1.78	1.57	1.47	1.25	1.11	1.05	1.0	0.81	0.57
JSMD0805-125L/12	1.78	1.57	1.47	1.25	1.11	1.05	1.0	0.81	0.57
JSMD0805-150L	2.14	1.88	1.76	1.5	1.33	1.25	1.2	0.97	0.68
JSMD0805-150L/12	2.14	1.88	1.76	1.5	1.33	1.25	1.2	0.97	0.68
JSMD0805-175L	2.5	2.19	2.05	1.75	1.55	1.46	1.4	1.13	0.79
JSMD0805-175L/12	2.5	2.19	2.05	1.75	1.55	1.46	1.4	1.13	0.79
JSMD0805-200L	2.85	2.51	2.35	2.0	1.77	1.67	1.6	1.29	0.91
JSMD0805-200L/12	2.85	2.51	2.35	2.0	1.77	1.67	1.6	1.29	0.91
JSMD0805-260L	3.71	3.25	3.06	2.6	2.3	2.17	2.08	1.68	1.18
JSMD0805-260L/12	3.71	3.25	3.06	2.6	2.3	2.17	2.08	1.68	1.18
JSMD0805-300L	4.29	3.75	3.53	3.0	2.65	2.5	2.4	1.94	1.36
JSMD0805-300L/12	4.29	3.75	3.53	3.0	2.65	2.5	2.4	1.94	1.36
JSMD0805-350L	5.0	4.38	4.12	3.5	3.09	2.92	2.8	2.26	1.59
JSMD0805-350L/12	5.0	4.38	4.12	3.5	3.09	2.92	2.8	2.26	1.59
JSMD0805-380L	5.43	4.76	4.47	3.8	3.35	3.17	3.04	2.45	1.73
JSMD0805-380L/12	5.43	4.76	4.47	3.8	3.35	3.17	3.04	2.45	1.73
JSMD0805-400L	5.72	5.0	4.71	4.0	3.53	3.33	3.2	2.59	1.81
JSMD0805-400L/12	5.72	5.0	4.71	4.0	3.53	3.33	3.2	2.59	1.81

Soldering Parameters

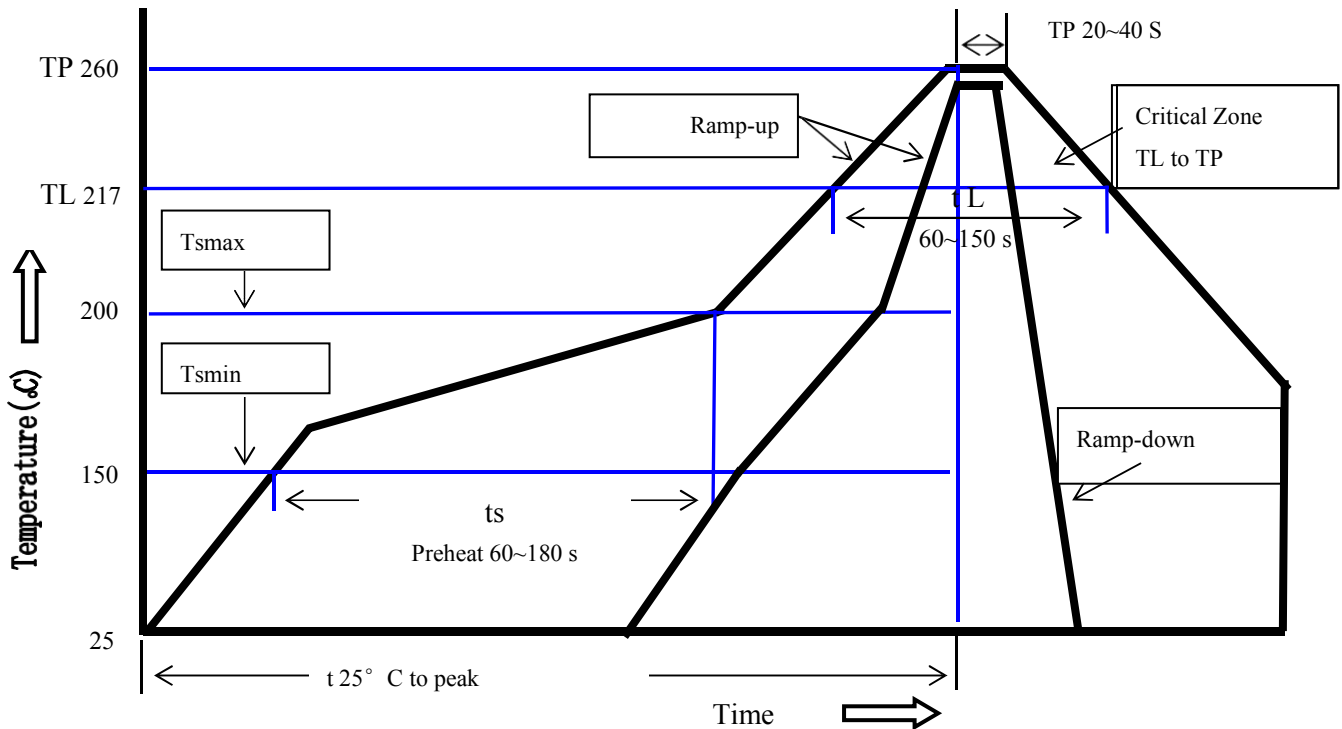

Profile Feature	Pb-Free Assembly
Average Ramp-Up Rate(Ts max to T p)	3°C/second max.
Preheat	
-Temperature Min(Ts min)	150°C
-Temperature Max(Ts max)	200°C
-Time(Ts min to Ts max)	60~180 seconds
Time maintained above:	
-Temperature(TL)	217°C
-Time(tL)	60~150 seconds
Peak Temperature(Tp)	260°C
Ramp-Down Rate	6°C/second max.
Time 25°C to Peak Temperature	8 minutes max
Storage Condition	0°C~35°C, ≤70%RH

Recommended reflow methods: IR, vapor phase oven, hot air oven, N2 environment for lead-free

Recommended maximum paste thickness is 0.25mm

Devices can be cleaned using standard industry methods and solvents.

Note 1: All temperature refer to topside of the package, measured on the package body surface.

Note 2: If reflow temperatures exceed the recommended profile, devices may not meet the performance requirements.

Physical Dimensions(mm.)

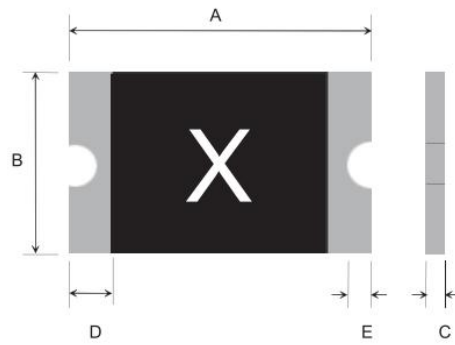

Model	A		B		C		D	E
	Min.	Max.	Min.	Max.	Min.	Max.	Min.	Min.
JSMD0805-075L/12	2.0	2.2	1.2	1.5	0.3	0.7	0.2	0.1
JSMD0805-110L	2.0	2.2	1.2	1.5	0.3	0.7	0.2	0.1
JSMD0805-110L/12	2.0	2.2	1.2	1.5	0.3	0.7	0.2	0.1
JSMD0805-125L	2.0	2.2	1.2	1.5	0.3	0.7	0.2	0.1
JSMD0805-125L/12	2.0	2.2	1.2	1.5	0.3	0.7	0.2	0.1
JSMD0805-150L	2.0	2.2	1.2	1.5	0.3	0.7	0.2	0.1
JSMD0805-150L/12	2.0	2.2	1.2	1.5	0.3	0.7	0.2	0.1
JSMD0805-175L	2.0	2.2	1.2	1.5	0.3	0.7	0.2	0.1
JSMD0805-175L/12	2.0	2.2	1.2	1.5	0.3	0.7	0.2	0.1
JSMD0805-200L	2.0	2.2	1.2	1.5	0.3	0.7	0.2	0.1
JSMD0805-200L/12	2.0	2.2	1.2	1.5	0.3	0.7	0.2	0.1
JSMD0805-260L	2.0	2.2	1.2	1.5	0.5	1.1	0.2	0.1
JSMD0805-260L/12	2.0	2.2	1.2	1.5	0.5	1.1	0.2	0.1
JSMD0805-300L	2.0	2.2	1.2	1.5	0.5	1.1	0.2	0.1
JSMD0805-300L/12	2.0	2.2	1.2	1.5	0.5	1.1	0.2	0.1
JSMD0805-350L	2.0	2.2	1.2	1.5	0.6	1.4	0.2	0.1
JSMD0805-350L/12	2.0	2.2	1.2	1.5	0.6	1.4	0.2	0.1
JSMD0805-380L	2.0	2.2	1.2	1.5	0.6	1.4	0.2	0.1
JSMD0805-380L/12	2.0	2.2	1.2	1.5	0.6	1.4	0.2	0.1
JSMD0805-400L	2.0	2.2	1.2	1.5	0.6	1.4	0.2	0.1
JSMD0805-400L/12	2.0	2.2	1.2	1.5	0.6	1.4	0.2	0.1

Termination Pad Characteristics

Terminal pad materials: Tin-plated Nickel-Copper

Terminal pad solder ability: Meets EIA specification RS186-9E and ANSI/J-STD-002 Category 3

Recommended Pad Layout (mm.)

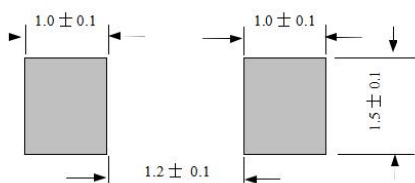

Packaging Quantity

Tape & reel packaging per EIA481-1

Part Number	Quantity
JSMD 0805 LoR Series	5,000 pcs/reel

Tape And Reel Specifications (mm)

Governing Specifications	EIA 481-1
W	8.0 ± 0.3
P0	4.0 ± 0.10
P1	4.0 ± 0.10
P2	2.0 ± 0.05
A0	1.45 ± 0.10
B0	2.30 ± 0.10
B1max	4.35
D0	1.55 + 0.10,-0
F	3.5 ± 0.05
E1	1.75 ± 0.10
E2min.	6.25
T	0.25
T1max.	0.1
K0	0.74 ± 0.1
Leader min.	390
Trailer min.	160
Reel Dimensions	
A max.	178
N min.	60
W1	9.0 ± 0.5
W2	12.0 ± 0.05

EIA Tape Component Dimensions

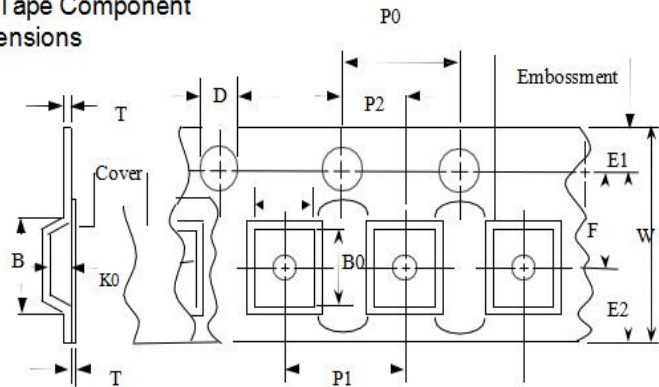

EIA Reel Dimensions

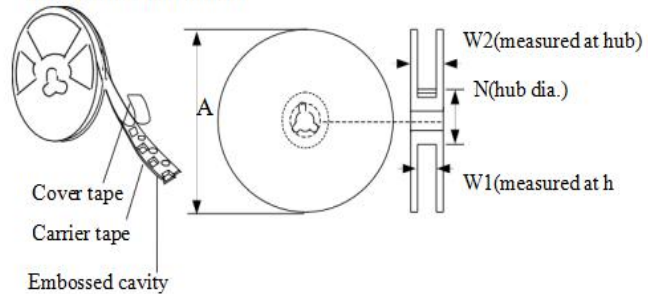

Storage And Handling

- Storage conditions: 35°C max, 70% R.H.
- Devices may not meet specified performance if storage conditions are exceeded.

Part Number System

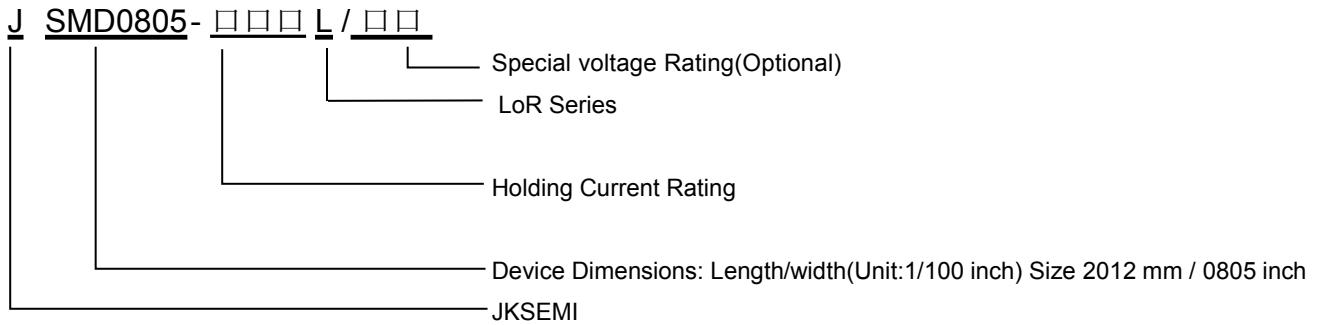

Cross Reference

JKSEMI	Cross Reference				
	Littelfuse	Bourns/Multifuse®	Polytronics /EVERFUSE®	Wayon	TLC
JSMD0805-075L/12	0805L075/8SL	MF-PSML075/12	SMD0805P075SLR/12	LP-ISML075/12	TLC-PSML075
JSMD0805-110L	0805L110/6	MF-PSML110/6	SMD0805P110SLR/6	LP-ISML110/8	TLC-PSML110/6
JSMD0805-110L/12	0805L110/8SL	MF-PSML110/12	SMD0805P110SLR/12	LP-ISML110/12	-
JSMD0805-125L	0805L125SL/6	MF-PSML125/6	SMD0805P125SLR/6	LP-ISML125/8	TLC-PSML125/6
JSMD0805-125L/12	0805L125/8SL	MF-PSML125/12	-	LP-ISML125/12	-
JSMD0805-150L	0805L150SL/6	MF-PSML150/6	SMD0805P150SLR/6	LP-ISML150/8	TLC-PSML150/6
JSMD0805-150L/12	0805L150/8SL	MF-PSML150/12	SMD0805P150SLR/12	LP-ISML150/12	-
JSMD0805-175L	0805L175UL/6	MF-PSML175/6	SMD0805P175SLR/6	LP-ISML175/8	TLC-PSML175/6
JSMD0805-175L/12	-	MF-PSML175/12	-	LP-ISML175/12	-
JSMD0805-200L	0805L200SL/6	MF-PSML200/6	SMD0805P200SLRT/6	LP-ISML200/8	TLC-PSML200/6
JSMD0805-200L/12	-	MF-PSML200/12	SMD0805P200SLR/12	LP-ISML200/12	-
JSMD0805-260L	0805L260ULTH/6	MF-PSML260/6	SMD0805P260SLRT/6	LP-ISML260/8	TLC-PSML260/6
JSMD0805-260L/12	-	MF-PSML260/12	-	LP-ISML260/12	-
JSMD0805-300L	0805L300SL/6	MF-PSML300/6	SMD0805P300SLRT/6	LP-ISML300/8	TLC-PSML300/6
JSMD0805-300L/12	-	MF-PSML300/12	-	LP-ISML300/12	-
JSMD0805-350L	0805L350SL/6	MF-PSML350/6	SMD0805P350SLR/6	LP-ISML350/8	TLC-PSML350/6
JSMD0805-350L/12	-	-	-	LP-ISML350/12	-
JSMD0805-380L	-	MF-PSML380/8	SMD0805P380SLR/6	LP-ISML380/8	TLC-PSML380/6
JSMD0805-380L/12	-	-	-	-	-
JSMD0805-400L	-	MF-PSML400/8	SMD0805P400SLR/6	LP-ISML400/8	TLC-PSML400/6
JSMD0805-400L/12	-	-	-	-	-

“Littelfuse” is a registered trademark of Littelfuse.

“Multifuse” is a registered trademark of bourns,Inc.

“EVERFUSE” is a registered trademark of Polytronics Technology Corp.

“Wayon” is a registered trademark of Wayon electronic corp.

“TLC” is a registered trademark of TLC electronic corp.

Website: <http://www.jksemi.com>

For additional information, please contact your local Sales Representative.

©Copyright 2016, jksemi



is a registered trademark of jksemi All rights are reserved

X-ON Electronics

Largest Supplier of Electrical and Electronic Components

Click to view similar products for [Resettable Fuses - PPTC](#) category:

Click to view products by [Jinkaisheng](#) manufacturer:

Other Similar products are found below :

[RF0077-000](#) [RF3256-000](#) [RF3281-000](#) [RF3301-000](#) [RF3344-000](#) [RF3350-000](#) [RF3382-000](#) [SMD125-2](#) [RF2171-000](#) [RF2531-000](#) [RF2873-000](#) [RF3060-000](#) [RF3288-000](#) [TR600-150Q-B-0.5-0.130](#) [RXE090](#) [5E4795/04-1502](#) [TRF250-080T-B-1.0-0.125](#) [SMD100-2](#) [NIS5452MT1TXG](#) [NIS5431MT1TXG](#) [SMD250-2](#) [0ZCM0001FF2G](#) [0ZCM0003FF2G](#) [0ZCM0004FF2G](#) [F95456-000](#) [RS30-090](#) [RS30-700](#) [RS30-800](#) [RS30-900](#) [RS60RB-005](#) [RS60RB-010](#) [RS60RB-020](#) [RS60RB-025](#) [RS60RB-050](#) [RS60RB-075](#) [RS60RB-160](#) [RS60SB-110](#) [RS60SB-135](#) [SB250-030](#) [SB250-040](#) [SB250-200](#) [SB250-600](#) [R60-375](#) [SMD1812K125SF16V](#) [SMD1812K200SF8V](#) [SMD1812K014SF60V](#) [K60X005](#) [K250R120](#) [0ZCH0110AF2E](#) [0603L001/60YR](#)