

Performance Specification

Model	Mar king	Maximum							Resistance	
		V _{max}	I _{max}	I _{hold}	I _{trip}	P _d	Time To Trip		R _{i min}	R _{1max}
				@25°C	@25°C	Typ.	Current	Time	(Ω)	(Ω)
		(V dc)	(A)	(A)	(A)	(W)	(A)	(Sec)		
JK-SMD 010SF	1	15.0	100	0.10	0.30	0.5	0.5	1.50	1.000	6.000
JK-SMD 020SF	2	9.0	100	0.20	0.50	0.5	8.0	0.02	0.650	3.500
JK-SMD 035SF	3	6.0	100	0.35	0.75	0.5	8.0	0.10	0.250	1.200
JK-SMD 050SF	5	6.0	100	0.50	1.00	0.5	8.0	0.10	0.150	0.850
JK-SMD 075SF	7	6.0	40	0.75	1.50	0.6	8.0	0.20	0.090	0.385
JK-SMD 100SF	0	6.0	100	1.00	1.95	0.6	8.0	0.30	0.060	0.230
JK-SMD 110SF	0	6.0	100	1.10	2.20	0.6	8.0	0.30	0.060	0.210
JK-SMD 125SF	12	6.0	100	1.25	2.50	1.5	8.0	0.60	0.030	0.140

V_{max} = Maximum operating voltage device can withstand without damage at rated current (I_{max}).

I_{max} = Maximum fault current device can withstand without damage at rated voltage (V_{max}).

I_{hold} = Hold Current. Maximum current device will not trip in 25°C still air.

I_{trip} = Trip Current. Minimum current at which the device will always trip in 25°C still air.

P_d = Power dissipation when device is in the tripped state in 25°C still air environment at rated voltage.

R_{i min/max} = Minimum/Maximum device resistance prior to tripping at 25°C.



R_{1max} = Maximum device resistance is measured one hour post reflow.

CAUTION : Operation beyond the specified ratings may result in damage and possible arcing and flame.

Environmental Specifications

Test	Conditions	Resistance change
Passive aging	+85°C, 1000 hrs.	±5% typical
Humidity aging	+85°C, 85% R.H. , 168 hours	±5% typical
Thermal shock	+85°C to -40°C, 20 times	±33% typical
Resistance to solvent	MIL-STD-202,Method 215	No change
Vibration	MIL-STD-202,Method 201	No change
Ambient operating conditions : - 40 °C to +85 °C		
Maximum surface temperature of the device in the tripped state is 125 °C		

Agency Approval and Environmental Compliance

Agency	File Number	Regulation	Standard
UL	E217453		2011/65/EU
TUV	pending		EN14582

Thermal Derating Chart

Recommended Hold Current(A) at Ambient Temperature(°C)

Model	Ambient Operation Temperature								
	-40°C	-20°C	0°C	25°C	40°C	50°C	60°C	70°C	85°C
JK-SMD 010SF	0.14	0.12	0.11	0.10	0.08	0.07	0.06	0.05	0.03
JK-SMD 020SF	0.28	0.25	0.23	0.20	0.17	0.14	0.12	0.10	0.07
JK-SMD 035SF	0.47	0.44	0.39	0.35	0.30	0.27	0.24	0.20	0.14
JK-SMD 050SF	0.68	0.62	0.55	0.50	0.40	0.37	0.33	0.29	0.23
JK-SMD 075SF	1.00	0.90	0.79	0.75	0.63	0.57	0.53	0.41	0.34
JK-SMD 100SF	1.35	1.25	1.15	1.00	0.82	0.74	0.65	0.55	0.42
JK-SMD 110SF	1.45	1.35	1.20	1.10	0.92	0.84	0.75	0.65	0.52
JK-SMD 125SF	1.65	1.53	1.36	1.25	1.05	0.95	0.85	0.74	0.59

Thermal Derating Curve

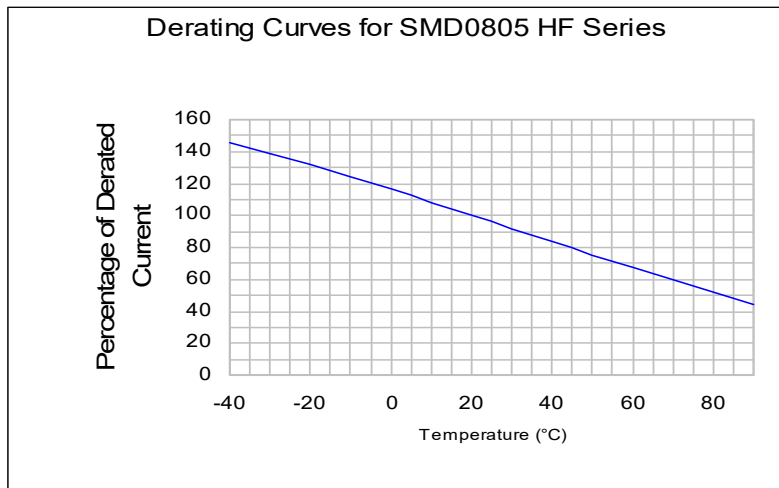

Average Time-Current Curve

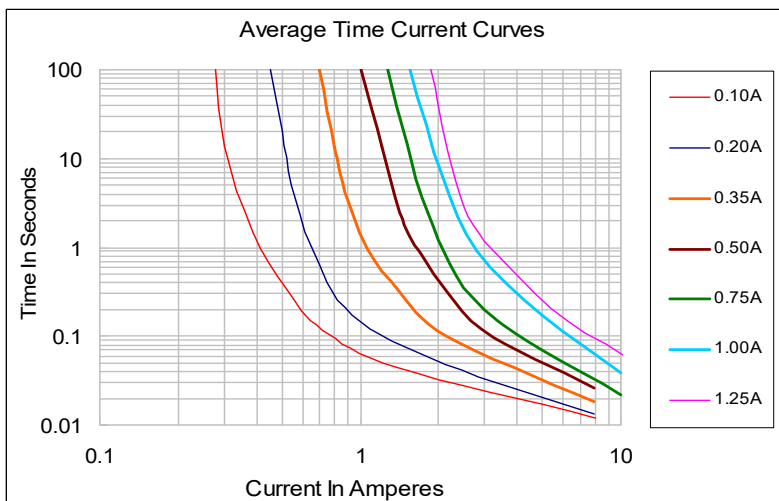

Soldering Parameters

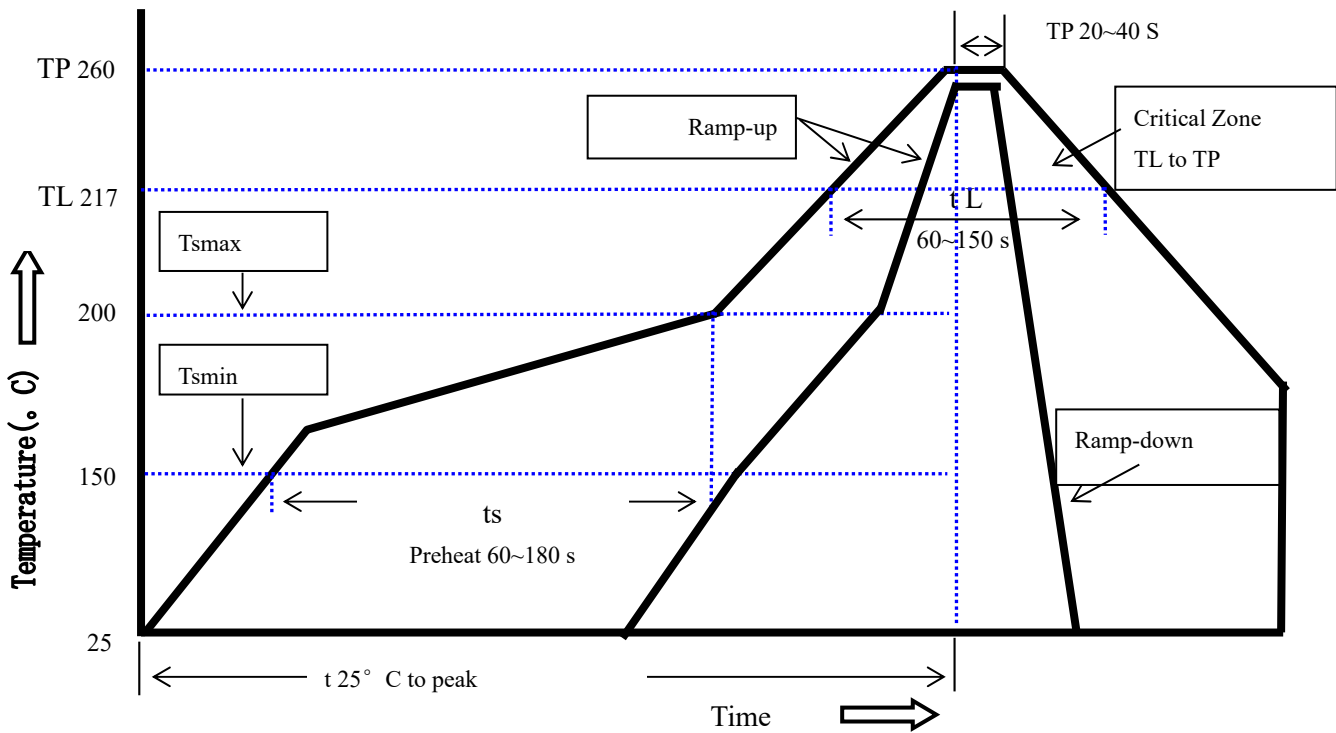

Profile Feature	Pb-Free Assembly
Average Ramp-Up Rate(Ts max to T p)	3°C/second mac.
Preheat	
-Temperature Min(Ts min)	150°C
-Temperature Max(Ts max)	200°C
-Time(Ts min to Ts max)	60~180 seconds
Time maintained above:	
-Temperature(TL)	217°C
-Time(tL)	60~150 seconds
Peak Temperature(Tp)	260°C
Ramp-Down Rate	6°C/second max.
Time 25°C to Peak Temperature	8 minutes max
Storage Condition	0°C~35°C, ≤70%RH

Recommended reflow methods: IR, vapor phase oven, hot air oven, N2 environment for lead-free

Recommended maximum paste thickness is 0.25mm

Devices can be cleaned using standard industry methods and solvents.

Note 1: All temperature refer to topside of the package, measured on the package body surface.

Note 2: If reflow temperatures exceed the recommended profile, devices may not meet the performance requirements.

Physical Dimensions(mm.)

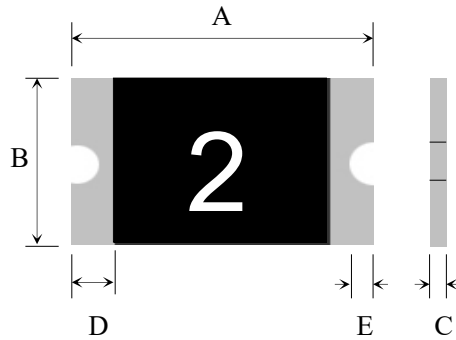

Model	A		B		C		D	E
	Min.	Max.	Min.	Max.	Min.	Max.	Min.	Min.
JK-SMD 010SF	2.00	2.20	1.20	1.50	0.50	1.00	0.20	0.10
JK-SMD 020SF	2.00	2.20	1.20	1.50	0.45	1.00	0.20	0.10
JK-SMD 035SF	2.00	2.20	1.20	1.50	0.45	1.00	0.20	0.10
JK-SMD 050SF	2.00	2.20	1.20	1.50	0.30	0.60	0.20	0.10
JK-SMD 075SF	2.00	2.20	1.20	1.50	0.40	1.00	0.20	0.10
JK-SMD 100SF	2.00	2.20	1.20	1.50	0.50	1.10	0.20	0.10
JK-SMD 110SF	2.00	2.20	1.20	1.50	0.50	1.20	0.20	0.10
JK-SMD 125SF	2.00	2.20	1.20	1.50	0.50	1.20	0.20	0.10

Termination Pad Characteristics

Terminal pad materials: Tin-plated Nickel-Copper

Terminal pad solder ability: Meets EIA specification RS186-9E and ANSI/J-STD-002 Category 3.

Recommended Pad Layout (mm.)

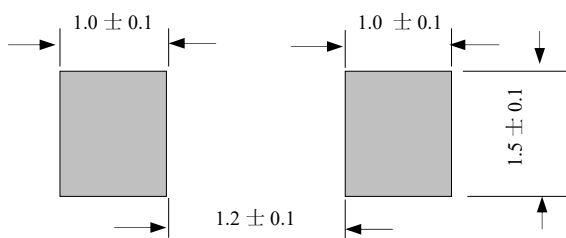

Packaging Quantity

Part Number	Quantity
JK-SMD 010.020.035.050.SF	5,000 pcs/reel
JK-SMD 075.100.110.125.SF	4,000 pcs/reel

Tape & reel packaging per EIA481-1

Tape And Reel Specifications (mm)

Governing Specifications	
Specifications	EIA 481-1
W	8.0 ± 0.3
P0	4.0 ± 0.10
P1	4.0 ± 0.10
P2	2.0 ± 0.05
A0	1.45 ± 0.10
B0	2.30 ± 0.10
B1max.	4.35
D0	1.55 + 0.1, -0
F	3.5 ± 0.05
E1	1.75 ± 0.10
E2min.	6.25
T	0.25
T1max.	0.1
K0	0.74 ± 0.1
Leader min.	390
Trailer min.	160
Reel Dimensions	
A max.	178
N min.	60
W1	9.0 ± 0.5
W2	12.0 ± 0.05

EIA Tape Component Dimensions

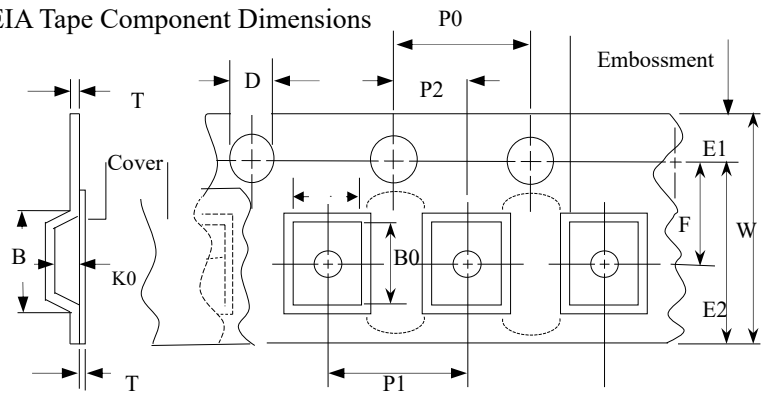

EIA Reel Dimensions

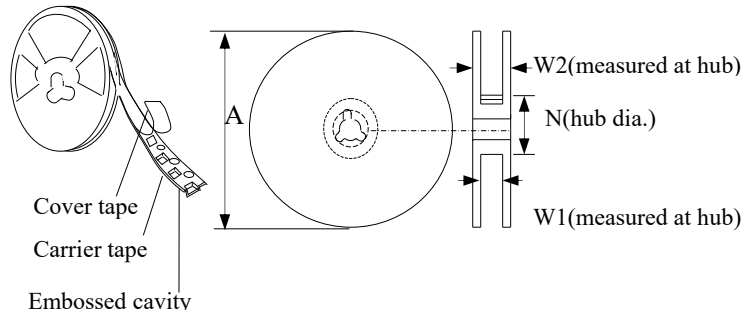

Storage And Handling

- Storage conditions: 35°C max, 70% R.H.
- Devices may not meet specified performance if storage conditions are exceeded.

Part Number System

JK - SMD □□□ S F □□ V

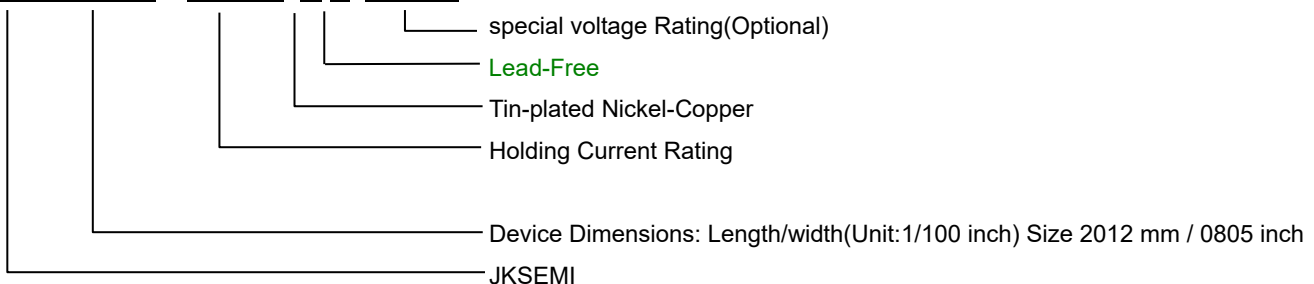

Cross Reference

JKSEMI	Cross Reference				
	TYCO/Raychem	Littelfuse	Bourns / Multifuse®	Polytronics / EVERFUSE®	SEA-LAND
JK-SMD 010SF	picoSMDC010S	0805L010	MF-PSMF010X	SMD0805P010TF	SMD0805-010
JK-SMD 020SF	picoSMDC020S	0805L020	MF-PSMF020X	SMD0805P020TF	SMD0805-020
JK-SMD 035SF	picoSMDC035S	0805L035	MF-PSMF035X	SMD0805P035TF	SMD0805-035
JK-SMD 050SF	picoSMDC050S	0805L050	MF-PSMF050X	SMD0805P050TF	SMD0805-050
JK-SMD 075SF	picoSMDC075S	0805L075	MF-PSMF075X	SMD0805P075TF	SMD0805-075
JK-SMD 100SF	-	0805L100	-	SMD0805P100TF	SMD0805-100
JK-SMD 110SF	picoSMDC110S	-	MF-PSMF110X	SMD0805P110TF	SMD0805-110
JK-SMD 125SF	-	-	-	-	SMD0805-125

“Raychem” is a registered trademark of Tyco Electronics.

“Littelfuse” is a registered trademark of Littelfuse

“Multifuse” is a registered trademark of bourns, Inc.

“EVERFUSE” is a registered trademark of Polytronics Technology Corp.

“SEA-LAND” is a registered trademark of Sea-Land electronic corp.

Website: <http://www.jksemi.com>

For additional information, please contact your local Sales Representative.

©Copyright 2016, jk semi



is a registered trademark of jk semi All rights are reserved

X-ON Electronics

Largest Supplier of Electrical and Electronic Components

Click to view similar products for [Resettable Fuses - PPTC](#) category:

Click to view products by [Jinkaisheng](#) manufacturer:

Other Similar products are found below :

[RF0077-000](#) [RF3256-000](#) [RF3281-000](#) [RF3301-000](#) [RF3344-000](#) [RF3382-000](#) [SMD125-2](#) [RF2171-000](#) [RF2531-000](#) [RF2873-000](#) [RF3060-000](#) [TR600-150Q-B-0.5-0.130](#) [RXE090](#) [5E4795/04-1502](#) [TRF250-080T-B-1.0-0.125](#) [SMD100-2](#) [NIS5452MT1TXG](#) [NIS5431MT1TXG](#) [SMD250-2](#) [0ZCM0001FF2G](#) [0ZCM0003FF2G](#) [0ZCM0004FF2G](#) [BK60-017-DZ-E0.6](#) [F95456-000](#) [LVR100S](#) [RS30-090](#) [RS30-600](#) [RS30-700](#) [RS30-800](#) [RS30-900](#) [RS60RB-005](#) [RS60RB-010](#) [RS60RB-020](#) [RS60RB-025](#) [RS60RB-050](#) [RS60RB-075](#) [RS60RB-160](#) [ASMD0603-010-30V](#) [ASMD0603-025-16V](#) [ASMD2920-260-24V](#) [BSMD0603-025-12V](#) [BSMD1206-150-12V](#) [BSMD0805-020-33V](#) [BSMD1206-075-13.2V](#) [BSMD2920-400-6V](#) [BSMD2920-300-6V](#) [BSMD2920-700-6V](#) [SMD1812-750-12V](#) [SMD1206-300C-12V](#) [SB250-145](#)