

FEATURES

- Fast Switching Speed
- For General Purpose Switching Applications
- High Conductance

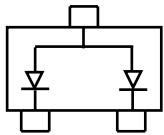

BAW56 Marking: A1

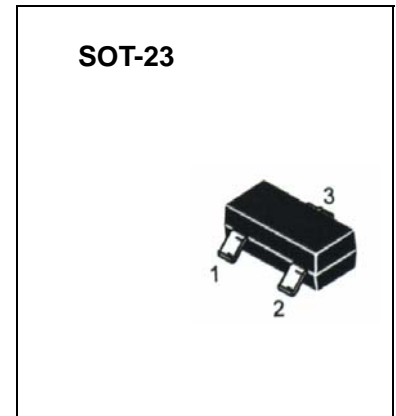
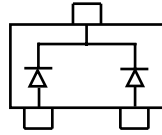

BAV70 Marking: A4

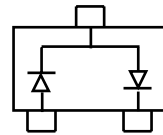

BAV99 Marking: A7

Maximum Ratings @T_A=25°C

Parameter	Symbol	Limits	Unit
Reverse voltage	V _R	70	V
Forward Current	I _F	200	mA
Peak Forward Surge Current	I _{FM(surge)}	500	mA
Power Dissipation	P _D	225	mW
Thermal Resistance Junction to Ambient Air	R _{θJA}	556	°C/W
Junction temperature	T _J	150	°C
Storage temperature range	T _{STG}	-55-150	°C

Electrical Characteristics @T_A=25°C

Parameter	Symbol	Min.	Typ.	Max.	Unit	Conditions
Reverse Breakdown Voltage	V _R	70			V	I _R =100μA
Forward voltage	V _{F1}			0.715	V	I _F =1mA
	V _{F2}			0.855	V	I _F =10mA
	V _{F3}			1	V	I _F =50mA
	V _{F4}			1.25	V	I _F =150mA
Reverse current	I _R			2.5	μA	V _R =70V
Capacitance between terminals	C _T			1.5	pF	V _R =0, f=1MHz
Reverse recovery time	t _{rr}			6	ns	I _F = I _R = 10mA, I _{rr} = 0.1 x I _R , R _L = 100Ω

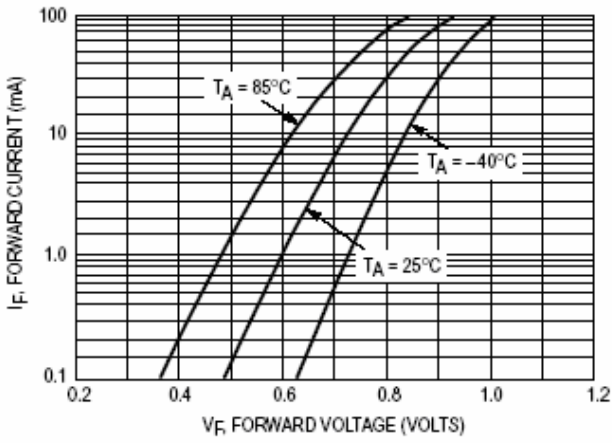

Figure 1. Forward Voltage

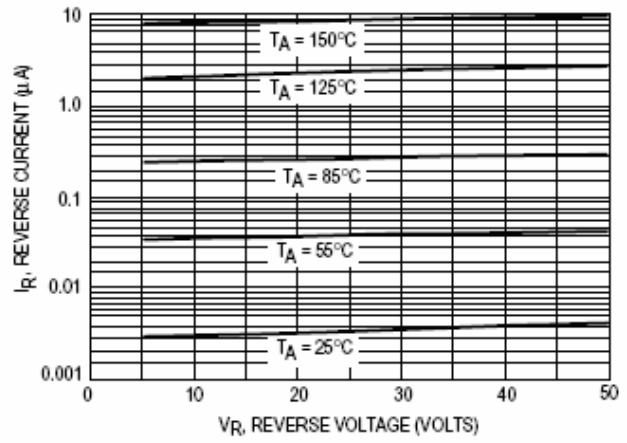

Figure 2 Leakage Current

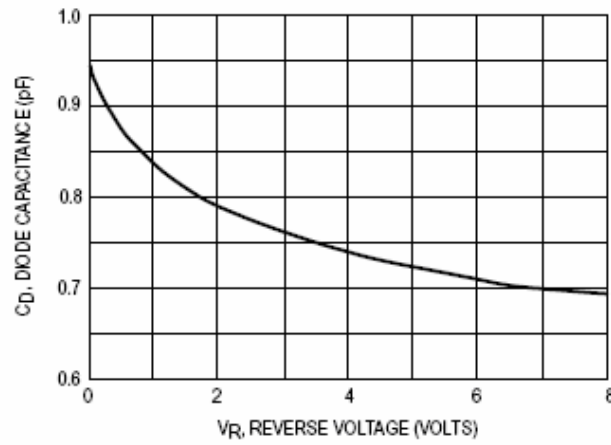

Figure 3 Capacitance

X-ON Electronics

Largest Supplier of Electrical and Electronic Components

Click to view similar products for [Diodes - General Purpose, Power, Switching category](#):

Click to view products by [Jinyu manufacturer](#):

Other Similar products are found below :

[MMBD3004S-13-F](#) [RD0306T-H](#) [DSE010-TR-E](#) [BAV17-TR](#) [BAV19-TR](#) [1N3611](#) [NTE156A](#) [NTE574](#) [NTE6244](#) [1SS181-TP](#) [1SS193,LF](#)
[1SS400CST2RA](#) [SDAA13](#) [SHN2D02FUTW1T1G](#) [LS4151GS08](#) [1N4449](#) [1N456A](#) [1N4934-E3/73](#) [1N914B](#) [1N914BTR](#) [1SS226-TP](#)
[RFUH20TB3S](#) [D291S45T](#) [BAV300-TR](#) [BAW56DWQ-7-F](#) [BAW75-TAP](#) [MM230L-CAA](#) [IDW40E65D1](#) [JAN1N3600](#) [LL4151-GS18](#)
[053684A](#) [SMMSD4148T3G](#) [707803H](#) [NSVDAN222T1G](#) [CDSZC01100-HF](#) [LL4150-M-08](#) [BAV199E6433HTMA1](#) [BAS28-7](#)
[BAW56HDW-13](#) [BAS28 TR](#) [VS-HFA04SD60STR-M3](#) [NSVM1MA152WKT1G](#) [RGP30D-E3/73](#) [BAV99TQ-13-F](#) [BAS21DWA-7](#) [NTE6250](#)
[NTE582-4](#) [NTE582-6](#) [MMDB30-E28X](#) [VS-HFA04SD60SL-M3](#)