

# Ceramic Component Solutions

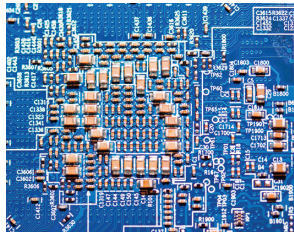

AC Safety Certified

High Voltage SMT

High Capacitance

High Temperature

EMI Filters

SMPS Stacks

High Voltage Radials

Precision Power Resistors

Power Inductors

Planar Array

Discoidal

CapStrate<sup>®</sup>

Custom Solutions

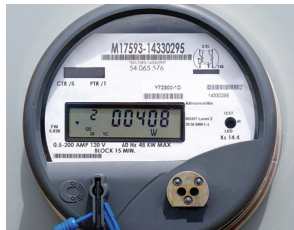
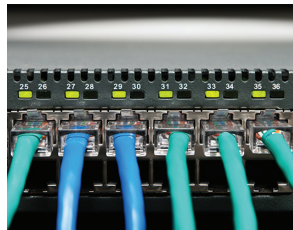

# YOUR TECHNOLOGY PARTNER



The mission of the Johanson Companies is to translate our customer needs into quality electronic components, produced in factories that are models of excellence, supported by innovative service. With over 30 years of experience, Johanson Dielectrics provides both standard and custom technology solutions tailored to your specific electronic applications.

Our standard product range includes High Voltage and AC Safety Capacitors providing solutions for Lighting, IT and Business Equipment designs. Our X2Y® Capacitor line provides advanced EMI filtering and IC decoupling solutions and our High Capacitance Tanceram® products provide the highest capacitance values in the smallest cases sizes.

Customized solutions in the areas of High Temperature and High AC power ceramic capacitors are available to customers who require a partnered technology solution.

Johanson Dielectrics design and manufacturing operations are located in Sylmar, California and Zhaoqing, PRC. Our quality minded management system utilizes continuous improvement programs focused on increased product reliability, manufacturing through-put, and product performance. Our broad experience, applications support, and responsive service enhance our ability to drive down your total cost of procurement and speed your time to market.

## **HIGH FREQUENCY CERAMIC SOLUTIONS**

Johanson Technology Inc., Camarillo CA. Products include High Q Capacitors, Ceramic and Wire-wound Chip Inductors, and a broad range of LTCC based RF IPCs such as Antennas, Filters, Baluns, Couplers, Matched Filter Baluns, etc.

**[www.johansontechnology.com](http://www.johansontechnology.com)**

Johanson Dielectrics, Inc. reserves the right to make design and price changes without notice. All sales are subject to the Johanson terms and conditions, including a limited warranty and remedies for non-conforming goods or defective goods. Download the Johanson terms and conditions from our website at <https://www.johansondielectrics.com/terms-and-conditions>.



# INDEX OF PRODUCTS

## ***SURFACE MOUNT CERAMIC CAPACITORS***

---

Ceramic Capacitor Prototyping Kits	4-5
High Voltage Capacitors 250 - 6,000 VDC	6-7
Safety Capacitors 250 VAC, Y2, X1, X2	8-9
EMI Filter & Decoupling Capacitors	10-13
High Temperature 200°C Capacitors	14-15
High Capacitance Tanceram® Capacitors	16-17
SMT Multi-layer Ceramic Capacitors 10 - 200 VDC	18-19

## ***LEADED CERAMIC CAPACITORS***

---

SMPS Stacked Capacitors, 125°C & 200°C versions	20-21
Mini-SMPS Stacked Capacitors	22-23
BME Mini SMPS Capacitors	24-25
Switch-mode Radial Leaded Capacitors	26-27
High Voltage Radial Leaded Capacitors, 125°C, 200°C versions	28-29

## ***PRECISION POWER RESISTORS***

---

Resistor Wirewound Precision	30-31
Resistor Wirewound Precision SMT	32-33
Resistor Wirewound High Power Rating	34-37
Resistor Wirewound Chassis Mount	38-40
Resistor Thin Film Precision	41-44
Resistor Metal Element Current Sense SMT	45-47
Resistor High Power Low Inductance	48-51
Resistor Thick Film, High Temperature	52-54
Resistor Metal Element Current Sense	55-56
Resistor Power Thin Film	57-59
Resistor Metal Element Shunts	60-63

## ***POWER INDUCTORS***

---

Semi-shielded (Coated) & Shielded	64-71
Shielded LPM Series	72-76

## ***PLANAR CAPACITORS & CUSTOM CERAMIC SOLUTIONS***

---

Planar Array Capacitors	77-78
-------------------------	-------

## ***CAPSTRATE & CUSTOMER CERAMIC SOLUTIONS***

---

CapStrate® & Customer Ceramic Solutions	79-80
---	-------

## ***PART NUMBER, DIELECTRIC, PACKAGING SPECIFICATIONS, INDEX***

---

Capacitor General Electrical Characteristics and PN breakdown	81
Capacitor Packaging	82
Index	83



# CERAMIC CAPACITOR ENGINEERING DESIGN KITS

Johanson Dielectrics, Inc. offers a variety of multi-layer chip capacitor sample kits for proto-type design work. Each kit is grouped by type, size, or voltage and contains a selection of popular values and tolerances. The chips are individually packaged in labeled plastic compartments for easy access. The general range of kit contents is described below. Specific part number details may be found at [www.johansondielectrics.com](http://www.johansondielectrics.com)



0402 Ceramic Chip Capacitor Kit					P/N: S-0402	
1400 piece sample assortment of selected values from 1.0pF to 0.22μF						
Chip Size	Voltage Rating	Dielectric	Capacitance Range	Qty / Value	Total Qty	
0402	50 VDC - 6.3 VDC	NPO, X7R	1.0pF to 0.22μF	50 pcs	1400 pcs	
0603 Ceramic Chip Capacitor Kit					P/N: S-0603	
1400 piece sample assortment of selected values from 1.0pF to 0.22μF						
Chip Size	Voltage Rating	Dielectric	Capacitance Range	Qty / Value	Total Qty	
0603	50 VDC - 16 VDC	NPO, X7R	10pF to 0.22μF	50 pcs	1400 pcs	
0805 Ceramic Chip Capacitor Kit					P/N: S-0805	
1400 piece sample assortment of selected values from 1.0pF to 0.47μF						
Chip Size	Voltage Rating	Dielectric	Capacitance Range	Qty / Value	Total Qty	
0805	100 VDC - 16 VDC	NPO, X7R	10pF to 0.47μF	50 pcs	1400 pcs	
500 VDC Ceramic Chip Capacitor Kit					P/N: S-500	
400 piece sample assortment of selected values from 33pF to 0.1μF						
Chip Size	Voltage Rating	Dielectric	Capacitance Range	Qty / Value	Total Qty	
0805 - 1812	500 VDC	NPO, X7R	33pF to 0.1μF	10-20 pcs	400 pcs	
1000 VDC Ceramic Chip Capacitor Kit					P/N: S-1KV	
400 piece sample assortment of selected values from 22pF to 0.1μF						
Chip Size	Voltage Rating	Dielectric	Capacitance Range	Qty / Value	Total Qty	
0805 - 2225	1000 VDC	NPO, X7R	22pF to 0.1μF	10-20 pcs	400 pcs	

*Johanson may from time-to-time adjust actual kit contents based on design demand trends. Check the Johanson web site for design kit updates and kit content changes.*

# CERAMIC CAPACITOR ENGINEERING DESIGN KITS

2000 VDC Ceramic Chip Capacitor Kit					P/N: S-2KV
300 piece sample assortment of selected values from 22pF to 0.022μF					
Chip Size	Voltage Rating	Dielectric	Capacitance Range	Qty / Value	Total Qty
1206 - 2225	2000 VDC	NP0, X7R	22pF to 0.022μF	10-20 pcs	300 pcs

X2 SAFETY CERTIFIED Ceramic Chip Capacitor Kit					P/N: S-SY3
240 piece sample assortment of selected values from 10pF to 1500 pF					
Chip Size	Voltage Rating	Dielectric	Capacitance Range	Qty / Value	Total Qty
1808	3KV DC / 250 AC	NP0, X7R	10pF to 1500 pF	20 pcs	240 pcs

X1/Y2 SAFETY CERTIFIED Ceramic Chip Capacitor Kit					P/N: S-SY2
200 piece sample assortment of selected values from 10pF to 2200 pF					
Chip Size	Voltage Rating	Dielectric	Capacitance Range	Qty / Value	Total Qty
1808 - 2220	5KV DC / 250 VAC	NP0, X7R	10pF to 2200pF	20 pcs	200 pcs

EMI FILTER Capacitor Kit - 0402 Size					P/N: S-X07CBK
600 piece sample assortment of selected values from 1.0pF to 0.01μF					
Chip Size	Voltage Rating	Dielectric	Capacitance Range	Qty / Value	Total Qty
0402	10 - 50 VDC	NP0, X7R	1.0pF to 0.01μF	50 pcs	600 pcs

EMI FILTER Capacitor Kit - 0603 Size					P/N: S-X14CBK
700 piece sample assortment of selected values from 1.0pF to 0.01μF					
Chip Size	Voltage Rating	Dielectric	Capacitance Range	Qty / Value	Total Qty
0603	50 - 100 VDC	NP0, X7R	1.0pF to 0.01μF	50 pcs	700 pcs

POWER BYPASS Capacitor Kit - 0603 Size					P/N: S-X14-PBP
300 piece sample assortment of selected values from 0.47nF to 0.220μF					
Chip Size	Voltage Rating	Dielectric	Capacitance Range	Qty / Value	Total Qty
0603	6.3 - 100 VDC	X7R, X5R	0.47nF to 0.22μF	20 pcs	300 pcs

EMI FILTER Capacitor Kit - 0805 Size					P/N: S-X15-EMI
260 piece sample assortment of selected values from 1.0pF to 0.01μF					
Chip Size	Voltage Rating	Dielectric	Capacitance Range	Qty / Value	Total Qty
0805	50 - 100 VDC	NP0, X7R	1.0pF to 0.01μF	20 pcs	260 pcs

AUTOMOTIVE QUALIFIED capacitor kit					P/N: S-X2Y-AEC
420 piece sample assortment of selected values from 100pF to 0.22μF					
Chip Size	Voltage Rating	Dielectric	Capacitance Range	Qty / Value	Total Qty
0603, 0805, 1206	10 - 100 VDC	X7R	100pF to 0.22μF	30 pcs	420 pcs

*Johanson may from time-time adjust actual kit contents based on design demand trends.  
Check the Johanson web site for design kit updates and kit content changes.*



# HIGH VOLTAGE SURFACE MOUNT MLCCs 250 - 6,000 VDC



These high voltage capacitors feature a special internal electrode design which reduces voltage concentrations by distributing voltage gradients throughout the entire capacitor.

This unique design also affords increased capacitance values in a given case size and voltage rating. The capacitors are designed and manufactured to the general requirement of EIA198 and are subjected to a 100% electrical testing making them well suited for a wide variety of telecommunication, commercial, and industrial applications.





## APPLICATIONS

- Analog & Digital Modems
- LAN/WAN Interface
- Lighting Ballast Circuits
- Voltage Multipliers
- DC-DC Converters
- Back-lighting Inverters

Polyterm® soft termination option for demanding environments & processes available on select parts, please contact the factory.

## CASE SIZE

## CAPACITANCE SELECTION





JDI / EIA	INCHES	(MM)	RATED VOLTAGE	NP0 DIELECTRIC		X7R DIELECTRIC		
				MINIMUM	MAXIMUM	MINIMUM	MAXIMUM	
<b>R15/0805</b> 	L	.080 ±.010	(2.03 ±.25)	250 VDC	-	-	1000 pF	0.022 µF
	W	.050 ±.010	(1.27 ±.25)	500 VDC	10 pF	680 pF	1000 pF	0.010 µF
	T	.055 Max.	(1.40)	630 VDC	10 pF	560 pF	1000 pF	6800 pF
	E/B	.020 ±.010	(0.51±.25)	1000 VDC	10 pF	390 pF	100 pF	2700 pF
				250 VDC	-	-	1000 pF	0.068 µF
<b>R18/1206</b> 	L	.125 ±.010	(3.18 ±.25)	500 VDC	10 pF	1500 pF	1000 pF	0.033 µF
	W	.062 ±.010	(1.57 ±.25)	630 VDC	10 pF	1200 pF	1000 pF	0.027 µF
	T	.067 Max.	(1.70)	1000 VDC	10 pF	1000 pF	100 pF	0.010 µF
	E/B	.020 ±.010	(0.51±.25)	2000 VDC	10 pF	220 pF	100 pF	4700 pF
				3000 VDC	10 pF	82 pF	100 pF	1000 pF
				250 VDC	-	-	1000 pF	0.150 µF
<b>S41/1210</b> 	L	.125 ±.010	(3.18 ±.25)	500 VDC	10 pF	3900 pF	1000 pF	0.068 µF
	W	.095 ±.010	(2.41 ±.25)	630 VDC	10 pF	2700 pF	1000 pF	0.047 µF
	T	.080 Max.	(2.03)	1000 VDC	10 pF	1800 pF	100 pF	0.015 µF
	E/B	.020 ±.010	(0.51±.25)	2000 VDC	10 pF	560 pF	100 pF	4700 pF
				3000 VDC	10 pF	220 pF	100 pF	1000 pF
				500 VDC	10 pF	4700 pF	1000 pF	0.100 µF
<b>R29/1808</b> 	L	.185 ±.020	(4.70 ±.51)	630 VDC	10 pF	3300 pF	1000 pF	0.047 µF
	W	.080 ±.010	(2.03 ±.25)	1000 VDC	1.0 pF	2200 pF	100 pF	0.022 µF
	T	.085 Max.	(2.16)	2000 VDC	1.0 pF	820 pF	100 pF	0.010 µF
	E/B	.020 ±.010	(0.51±.25)	3000 VDC	1.0 pF	470 pF	100 pF	3300 pF
				4000 VDC	1.0 pF	180 pF	100 pF	1800 pF
				5000 VDC	1.0 pF	75 pF	47 pF	390 pF
				6000 VDC	1.0 pF	75 pF	47 pF	150 pF

Available cap. values include these significant retma values and their multiples: 1.0 1.2 1.5 1.8 2.2 2.7 3.3 3.9 4.7 5.6 6.8 8.2 (1.0 = 1.0, 10, 100, 1000, etc.) Consult factory for non-retma values and sizes or voltages not shown.

# HIGH VOLTAGE SURFACE MOUNT MLCCs 250 - 6,000 VDC

## CASE SIZE

## CAPACITANCE SELECTION

JDI / EIA	INCHES	(MM)	RATED VOLTAGE	NP0 DIELECTRIC		X7R DIELECTRIC						
				MINIMUM	MAXIMUM	MINIMUM	MAXIMUM					
<b>S43 / 1812</b> 	L W T E/B	.177 ±.012 .125 ±.010 .110 Max. .025 ±.015	(4.50 ±.30) (3.18 ±.25) (2.80) (0.64±.38)	250 VDC	-	-	0.010 µF	0.470 µF				
				500 VDC	100 pF	8200 pF	1000 pF	0.330 µF				
				630 VDC	100 pF	6800 pF	1000 pF	0.120 µF				
				1000 VDC	10 pF	5600 pF	1000 pF	0.100 µF				
				2000 VDC	10 pF	1800 pF	100 pF	0.010 µF				
				3000 VDC	10 pF	1000 pF	100 pF	4700 pF				
				4000 VDC	10 pF	390 pF	100 pF	1200 pF				
				5000 VDC	10 pF	150 pF	100 pF	820 pF				
				6000 VDC	10 pF	150 pF	10 pF	330 pF				
				<b>S49 / 1825</b> 	L W T E/B	.180 ±.010 .250 ±.010 .140 Max. .025 ±.015	(4.57 ±.25) (6.35 ±.25) (3.56) (0.64±.38)	500 VDC	100 pF	0.018 µF	0.01 µF	0.390 µF
630 VDC	100 pF	0.015 µF	0.01 µF					0.270 µF				
1000 VDC	10 pF	0.012 µF	1000 pF					0.180 µF				
2000 VDC	10 pF	5600 pF	100 pF					0.039 µF				
3000 VDC	10 pF	2200 pF	100 pF					8200 pF				
4000 VDC	10 pF	1200 pF	100 pF					2200 pF				
5000 VDC	10 pF	390 pF	100 pF					1500 pF				
6000 VDC	10 pF	390 pF	100 pF					820 pF				
<b>S47 / 2220</b> 	L W T E/B	.225 ±.015 .200 ±.015 .150 Max. .025 ±.015	(5.72 ±.38) (5.08 ±.38) (3.81) (0.64±.38)					500 VDC	1000 pF	0.018 µF	0.01 µF	0.470 µF
								630 VDC	1000 pF	0.018 µF	0.01 µF	0.270 µF
				1000 VDC	100 pF	0.015 µF	1000 pF	0.120 µF				
				2000 VDC	100 pF	5600 pF	1000 pF	0.039 µF				
				3000 VDC	10 pF	2700 pF	100 pF	0.010 µF				
				4000 VDC	10 pF	1500 pF	100 pF	2700 pF				
				5000 VDC	10 pF	470 pF	100 pF	1500 pF				
				6000 VDC	10 pF	470 pF	100 pF	820 pF				
				<b>S48 / 2225</b> 	L W T E/B	.225 ±.010 .255 ±.015 .160 Max. .025 ±.015	(5.72 ±.25) (6.48 ±.38) (4.06) (0.64±.38)	500 VDC	1000 pF	0.027 µF	0.01 µF	0.560 µF
								630 VDC	1000 pF	0.022 µF	0.01 µF	0.390 µF
1000 VDC	100 pF	0.018 µF	1000 pF					0.180 µF				
2000 VDC	100 pF	8200 pF	1000 pF					0.056 µF				
3000 VDC	10 pF	3300 pF	100 pF					0.012 µF				
4000 VDC	10 pF	1800 pF	100 pF					3300 pF				
5000 VDC	10 pF	470 pF	100 pF					2700 pF				
6000 VDC	10 pF	470 pF	100 pF					1200 pF				

Available cap. values include these significant retma values and their multiples: 1.0 1.2 1.5 1.8 2.2 2.7 3.3 3.9 4.7 5.6 6.8 8.2 (1.0 = 1.0, 10, 100, 1000, etc.) Consult factory for non-retma values and sizes or voltages not shown.

## ELECTRICAL CHARACTERISTICS

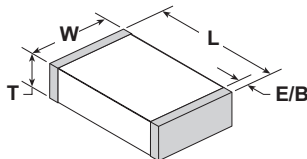

Meets the standard NP0 & X7R dielectric specifications listed on page 79

**DIELECTRIC WITHSTANDING VOLTAGE** DWV = 1.5 X rated WVDC for ratings 500-999 WVDC, DWV = 1.2 X rated WVDC for ratings ≥ 1,000 WVDC

NOTE: Capacitors may require a surface coating to prevent external arcing. Solder mask should not be used beneath capacitors. For more information see JDI Tech Note "Surface Arc Season"

## HOW TO ORDER HIGH VOLTAGE SURFACE MOUNT

P/N written: 202R18W102KV4E

202	R18	W	102	K	V	4	E
VOLTAGE	SIZE	DIELECTRIC	CAPACITANCE	TOLERANCE	TERMINATION	MARKING	PACKING
501 = 500 V 631 = 630 V 102 = 1000 V 202 = 2000 V 302 = 3000 V 402 = 4000 V 502 = 5000 V 602 = 6000 V	R15 = 0805 R18 = 1206 R29 = 1808 S41 = 1210 S43 = 1812 S47 = 2220 S48 = 2225 S49 = 1825	N = NP0 W = X7R	1st two digits are significant; third digit denotes number of zeros. 102 = 1000 pF 104 = 0.10 µF	J = ± 5% K = ± 10% M = ± 20%	V = Ni Barrier with 100% Sn Plating (Matte)  F = Polyterm flexible termination T = SnPb	4 = Unmarked 6 = EIA Code	E = Embossed 7" T = Punched 7"  No code = bulk Tape specs. per EIA RS481



# AC SAFETY CAPACITORS

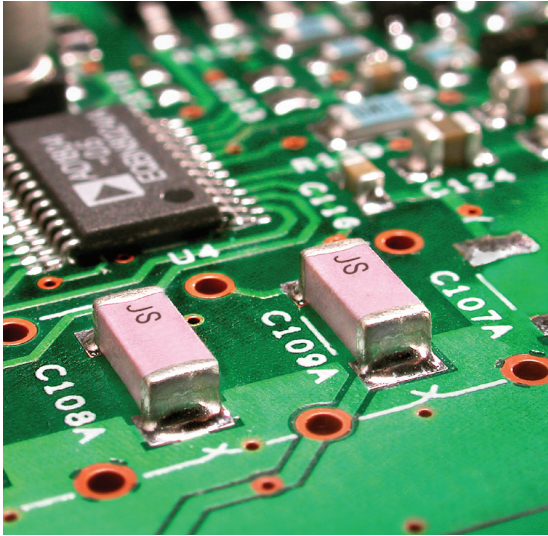

Johanson Dielectrics Type SC ceramic chip capacitors are designed for AC voltage surge and lightning protection in line-to-ground interface applications in computer networks, modem, facsimile and other equipment.

Johanson's safety capacitor offering includes four different case sizes in NPO and X7R dielectric materials.

These devices are surface mount ready with barrier terminations and tape and reel packaging.

Information on capacitor safety ratings and certification details may be found below.

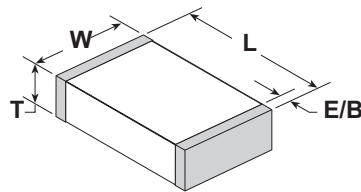

Polyterm® soft termination option for demanding environments & processes available on select parts, please contact the factory.







SAFETY RATING	VOLTAGE RATING	WITHSTANDING VOLTAGE	IMPULSE VOLTAGE	CASE SIZE	JOHANSON ORDERING P/N
X2	250 VAC	1,500 VAC	2,500 V	1808	302R29____V3E-****-SC
STANDARDS: IEC/EN 60384-14:2013+A1:2016 • UL 60384-14 CERTIFICATIONS: TUV R 50227900 & T 72140662 • UL File E472557 & E212609					
X2	250 VAC	1,500 VAC	2,500 V	1812	302S43____V3E-****-SC
STANDARDS: IEC/EN 60384-14:2013+A1:2016 • UL 60384-14 CERTIFICATIONS: TUV R 50227900 & T 72140662 • UL File E472557 & E212609					
X1/Y2	250 VAC	1,500 VAC	5,000 V	1808	502R29____V3E-****-SC
STANDARDS: IEC/EN 60384-14:2013+A1:2016 • UL 60384-14 CERTIFICATIONS: TUV R 50227900 & T 72140662 • UL File E472557 & E212609					
X1/Y2	250 VAC	1,500 VAC	5,000 V	1812	502S43____V3E-****-SC
STANDARDS: IEC/EN 60384-14:2013+A1:2016 • UL 60384-14 CERTIFICATIONS: TUV R 50227900 & T 72140662 • UL File E472557 & E212609					
X1/Y2	250 VAC	1,500 VAC	5,000 V	2211	502R30____V3E-****-SC
STANDARDS: IEC/EN 60384-14:2013+A1:2016 • UL 60384-14 CERTIFICATIONS: TUV R 50227900 & T 72140662 • UL File E472557 & E212609					
X1/Y2	250 VAC	1,500 VAC	5,000 V	2220	502S47____V3E-****-SC
STANDARDS: IEC/EN 60384-14:2013+A1:2016 • UL 60384-14 CERTIFICATIONS: TUV R 50227900 & T 72140662 • UL File E472557 & E212609					

X Capacitors are defined as suitable for use in situations where failure of the capacitor would not lead to danger of electric shock.

Y Capacitors are defined as suitable for use in situations where failure of the capacitor could lead to danger of electric shock.



## SAFETY CERTIFIED

		INCHES	(MM)	5 pF	10 pF	12 pF	15 pF	18 pF	22 pF	27 pF	33 pF	47 pF	56 pF	68 pF	100 pF	120 pF	150 pF	180 pF	220 pF	270 pF	330 pF	470 pF	560 pF	680 pF	1000 pF	1200 pF	1500 pF	1800 pF	2200 pF	2700 pF	3300 pF	4700 pF
R29 / 1808  X2	L	.185 ±.015	(4.70 ±.38)																							DIELECTRIC NPO X7R						
	W	.080 ±.010	(2.03 ±.25)																													
	T	.085 Max.	(2.16)																													
	E/B	.020 ±.010	(0.51±.25)																													
R29 / 1808  X1/Y2	L	.185 ±.015	(4.70 ±.38)																							DIELECTRIC NPO X7R						
	W	.080 ±.015	(2.03 ±.38)																													
	T	.085 Max.	(2.16)																													
	E/B	.020 ±.010	(0.51±.25)																													
S43 / 1812  X2	L	.175 ±.010	(4.45 ±.25)																											DIELECTRIC NPO X7R		
	W	.125 ±.010	(3.18 ±.25)																													
	T	.115 Max.	(2.92)																													
	E/B	.025 ±.015	(0.64±.38)																													
S43 / 1812  X1/Y2	L	.175 ±.010	(4.45 ±.25)																							DIELECTRIC NPO X7R						
	W	.125 ±.010	(3.18 ±.25)																													
	T	.115 Max.	(2.92)																													
	E/B	.025 ±.015	(0.64±.38)																													
R30 / 2211  X1/Y2	L	.225 ±.016	5.72 ±.40																							DIELECTRIC NPO X7R						
	W	.110 ±.010	(2.80 ±.25)																													
	T	.115 Max.	(2.92)																													
	E/B	.020 ±.010	(0.51±.25)																													
S47 / 2220  X1/Y2	L	.225 ±.015	(5.72 ±.38)																							DIELECTRIC NPO X7R						
	W	.200 ±.015	(5.08 ±.38)																													
	T	.150 Max.	(3.81)																													
	E/B	.025 ±.015	(0.64±.38)																													

### HOW TO ORDER AC SAFETY CAPACITORS

P/N written: 302R29W102MV3E-\*\*\*\*-SC

502	R29	W	102	M	V	3	E	****-SC
VOLTAGE	SIZE	DIELECTRIC	CAPACITANCE	TOLERANCE	TERMINATION	MARKING	PACKING	TYPE
302 = 250VAC [2500V Impulse] 502 = 250VAC [5000V Impulse]	R29=1808 R30=2211 S43=1812 S47=2220 AC2=2220	N = NPO W = X7R	1st two digits are significant; third digit denotes number of zeros, R = decimal. 102 = 1000 pF 104 = 0.10 µF 5R0 = 5.0pF	J = ± 5% K = ± 10% M = ± 20%	V = NI Barrier with 100% Sn Plating (Matte) F = Polyterm flexible termination	3 = Required Safety Mark	E = Embossed 7" U = Embossed 13" No code = bulk Tape specs. per EIA RS481	SC = Safety Certified



# EMI® FILTER & DECOUPLING CAPACITORS

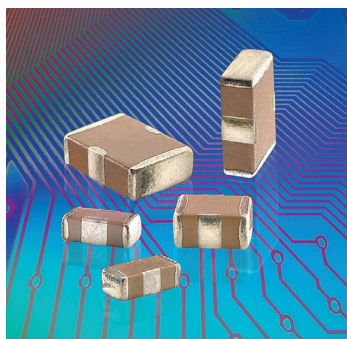

EMI® filter capacitors employ a unique, patented low inductance design featuring two balanced capacitors that are immune to temperature, voltage and aging performance differences. These components offer superior decoupling and EMI filtering performance, virtually eliminate parasitics, and can replace multiple capacitors and inductors saving board space and reducing assembly costs.

## ADVANTAGES

- One device for EMI suppression or decoupling
- Replace up to 7 components with one X2Y
- Differential and common mode attenuation
- Matched capacitance line to ground, both lines
- Low inductance due to cancellation effect

## APPLICATIONS

- Amplifier Filter & Decoupling
- High Speed Data Filtering
- EMC I/O Filtering
- FPGA / ASIC /  $\mu$ -P Decoupling
- DDR Memory Decoupling

Automotive version (AEC-Q200) available for many values: please see details in the below table of capacitance values. Please contact us if another value is needed for automotive application

EMI Filtering (1 Y-Cap.)	<10pF	10pF	22pF	27pF	33pF	47pF	100pF	220pF	470pF	1000pF	1500pF	2200pF	4700pF	.010 $\mu$ F	.015 $\mu$ F	.022 $\mu$ F	.039 $\mu$ F	.047 $\mu$ F	0.10 $\mu$ F	0.18 $\mu$ F	0.22 $\mu$ F	0.33 $\mu$ F	0.40 $\mu$ F	0.47 $\mu$ F	1.0 $\mu$ F	
Power Bypass (2 Y-Caps.)	<20pF	20pF	44pF	54pF	66pF	94pF	200pF	440pF	940pF	2000pF	3000pF	4400pF	9400pF	.020 $\mu$ F	.030 $\mu$ F	.044 $\mu$ F	.078 $\mu$ F	.094 $\mu$ F	0.20 $\mu$ F	0.36 $\mu$ F	0.44 $\mu$ F	0.66 $\mu$ F	0.80 $\mu$ F	0.94 $\mu$ F	2.0 $\mu$ F	
SIZE	CAP. CODE	XRX	100	220	270	330	470	101	221	471	102	152	222	472	103	153	223	393	473	104	184	224	334	404	474	105
0402 (X07)	NP0	50	50	50	50	50	50																			
	X7R							50	50	50	50	50	50	16												
0603 (X14)	NP0	100	100	100	100	100	50	50																		
	X7R						100	100	100	100	100	100	100	50	25	25			16	10		10				
0805 (X15)	NP0		100	100	100	100	100	100	50																	
	X7R						100	100	100	100	100	100	100	100	50	50			50	25						
1206 (X18)	NP0										100															
	X7R													100	100	100			100	100*		16	16		10	
1210 (X41)	X7R													500					100		100	100		25	16	
1410 (X44)	X7R														500								100			
1812 (X43)	X7R																	500							100	

□ Automotive version currently available for those values only

\* Also proposed with a 50V rating (500X18W104MV4E) instead of 100V

Contact factory for part combinations not shown.

Filtering capacitance is specified as Line-to-Ground ( Terminal A or B to G)

Power Bypass capacitance is specified Power-to-Ground ( A + B to G)

Rated voltage is from line to ground in Circuit 1, power to ground in Circuit 2 .

## HOW TO ORDER EMI® CAPACITORS

P/N written: 101X14W102MV4T

100	X14	W	102	M	V	4	T	+AQ
VOLTAGE	SIZE	DIELECTRIC	CAPACITANCE	TOLERANCE	TERMINATION	MARKING	PACKING	QUALIFICATION
6R3 = 6.3 V 100 = 10 V 160 = 16 V 250 = 25 V 500 = 50 V 101 = 100 V 501 = 500 V	X07 = 0402 X14 = 0603 X15 = 0805 X18 = 1206 X41 = 1210 X44 = 1410 X43 = 1812	N = NP0 W = X7R	1st two digits are significant; third digit denotes number of zeros, R = decimal. 102 = 1000 pF 104 = 0.10 $\mu$ F 5R6 = 5.6pF	M = $\pm$ 20% * D = $\pm$ 0.50 pF *Values < 10 pF only	V = Ni Barrier with 100% Tin Plating (Matte) F = Polyterm flexible termination T = SnPb	4 = Unmarked (Not available)	E = Embossed 7" T = Punched 7" No code = bulk Tape specs. per EIA RS481	AEC-Q200 Qualification * (optional)



## EMI Filtering Scc21

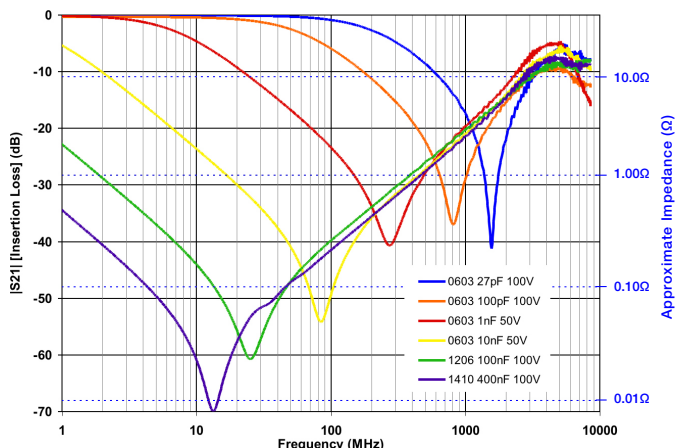
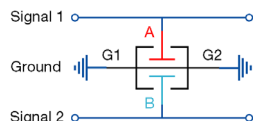

## Power Bypass S21

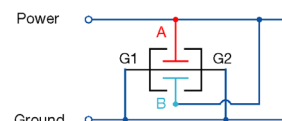

Labeled capacitance values below follow the P/N order code (single Y cap value)  
Effective capacitance measured in Circuit 2 is 2X of the labeled single Y cap value.

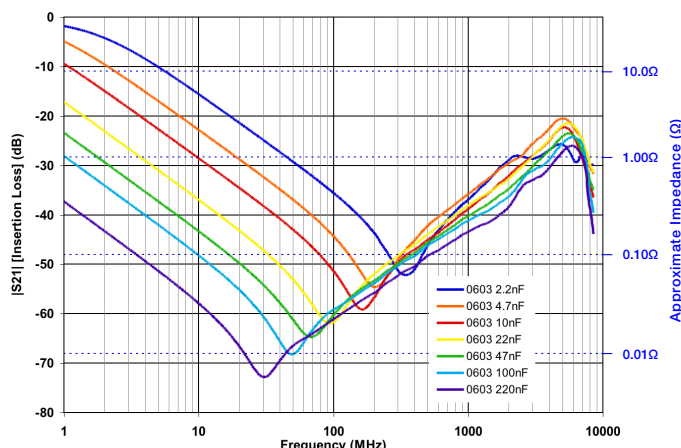

More data at <https://s21plotter.johansondielectrics.com/>

## ELECTRICAL CHARACTERISTICS

	NP0	X7R
TEMPERATURE COEFFICIENT:	0±30ppm/°C (-55 to +125°C)	±15% (-55 to +125°C)
DIELECTRIC STRENGTH:	Vrated ≤100VDC: DWV = 2.5 X WVDC, 25°C, 50mA max. Vrated = 500VDC: DWV = 1.5 X WVDC, 25°C, 50mA max.	
DISSIPATION FACTOR:	0.1% max.	WVDC ≥ 50 VDC: 2.5% max. WVDC = 25 VDC: 3.5% max. WVDC = 10-16 VDC: 5.0% max. WVDC = 6.3 VDC: 10% max.
INSULATION RESISTANCE (MIN. @ 25°C, WVDC)	C ≤ 0.047µF: 1000 ΩF or 100 GΩ, whichever is less C > 0.047µF: 500 ΩF or 10 GΩ, whichever is less	
TEST CONDITIONS:	C > 100 pF; 1kHz ±50Hz; 1.0±0.2 VRMS C ≤ 100 pF; 1Mhz ±50kHz; 1.0±0.2 VRMS	1.0kHz±50Hz @ 1.0±0.2 Vrms
OTHER:	See page 81 for additional dielectric specifications.	

### Cross-sectional View

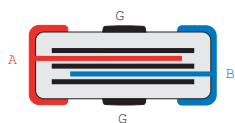

### Dimensional View

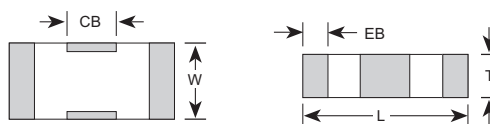

## CASE SIZE

	0402 (X07)		0603 (X14)		0805 (X15)		1206 (X18)		1210 (X41)		1410 (X44)		1812 (X43)	
	IN	MM	IN	MM	IN	MM	IN	MM	IN	MM	IN	MM	IN	MM
L	0.045 ± 0.003	1.143 ± 0.076	0.064 ± 0.005	1.626 ± 0.127	0.080 ± 0.008	2.032 ± 0.203	0.124 ± 0.010	3.150 ± 0.254	0.125 ± 0.010	3.175 ± 0.254	0.140 ± 0.010	3.556 ± 0.254	0.174 ± 0.010	4.420 ± 0.254
W	0.025 ± 0.003	0.635 ± 0.076	0.035 ± 0.005	0.889 ± 0.127	0.050 ± 0.008	1.270 ± 0.203	0.063 ± 0.010	1.600 ± 0.254	0.098 ± 0.010	2.489 ± 0.254	0.098 ± 0.010	2.490 ± 0.254	0.125 ± 0.010	3.175 ± 0.254
T	0.020 max	0.508 max	0.026 max	0.660 max	0.040 max	1.016 max	0.050 max	1.270 max	0.070 max	1.778 max	0.070 max	1.778 max	0.090 max	2.286 max
EB	0.008 ± 0.003	0.203 ± 0.076	0.010 ± 0.006	0.254 ± 0.152	0.012 ± 0.008	0.305 ± 0.203	0.016 ± 0.010	0.406 ± 0.254	0.018 ± 0.010	0.457 ± 0.254	0.018 ± 0.010	0.457 ± 0.254	0.022 ± 0.012	0.559 ± 0.305
CB	0.012 ± 0.003	0.305 ± 0.076	0.018 ± 0.004	0.457 ± 0.102	0.022 ± 0.005	0.559 ± 0.127	0.040 ± 0.005	1.016 ± 0.127	0.045 ± 0.005	1.143 ± 0.127	0.045 ± 0.005	1.143 ± 0.127	0.045 ± 0.005	1.143 ± 0.127



# X2Y® FILTER & DECOUPLING CAPACITORS

## THE X2Y® DESIGN - A BALANCED, LOW ESL, "CAPACITOR CIRCUIT"

The X2Y® capacitor design starts with standard 2 terminal MLC capacitor's opposing electrode sets, A & B, and adds a third electrode set (G) which surround each A & B electrode. The result is a highly versatile three node capacitive circuit containing two tightly matched, low inductance capacitors in a compact, four-terminal SMT chip.

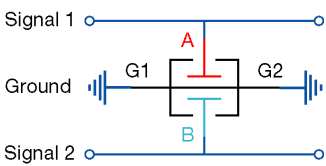
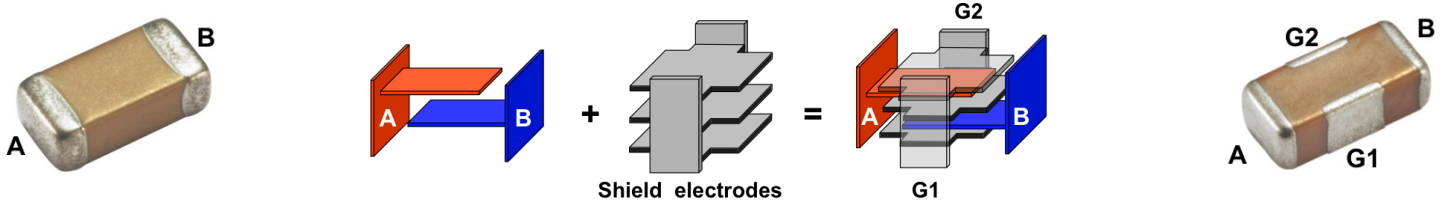

### EMI FILTERING:

The X2Y® component contains two shunt or "line-to-ground" Y capacitors. Ultra-low ESL (equivalent series inductance) and tightly matched inductance of these capacitors provides unequalled high frequency Common-Mode noise filtering with low noise mode conversion. X2Y® components reduce EMI emissions far better than unbalanced discrete shunt capacitors or series inductive filters. Differential signal loss is determined by the cut off frequency of the single line-to-ground (Y) capacitor value of an X2Y®.

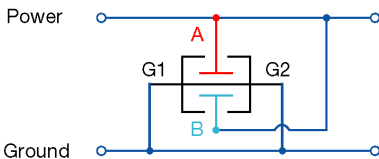

### POWER BYPASS / DECOUPLING

For Power Bypass applications, X2Ys® two "Y" capacitors are connected in parallel. This doubles the total capacitance and reduces their mounted inductance by 80% or 1/5th the mounted inductance of similar sized MLC capacitors enabling high-performance bypass networks with far fewer components and vias. Low ESL delivers improved High Frequency performance into the GHz range.

## GSM RFI ATTENUATION IN AUDIO & ANALOG

GSM handsets transmit in the 850 and 1850 MHz bands using a TDMA pulse rate of 217Hz. These signals cause the GSM buzz heard in a wide range of audio products from headphones to concert hall PA systems or "silent" signal errors created in medical, industrial process control, and security applications. Testing was conducted where an 840MHz GSM handset signal was delivered to the inputs of three different amplifier test circuit configurations shown below whose outputs were measured on a HF spectrum analyzer.

- 1) No input filter, 2 discrete MLC 100nF power bypass caps.
- 2) 2 discrete MLC 1nF input filter, 2 discrete MLC 100nF power bypass caps.
- 3) A single X2Y 1nF input filter, a single X2Y 100nF power bypass cap.

X2Y configuration provided a nearly flat response above the ambient and up to 10 dB improved rejection than the conventional MLCC configuration.

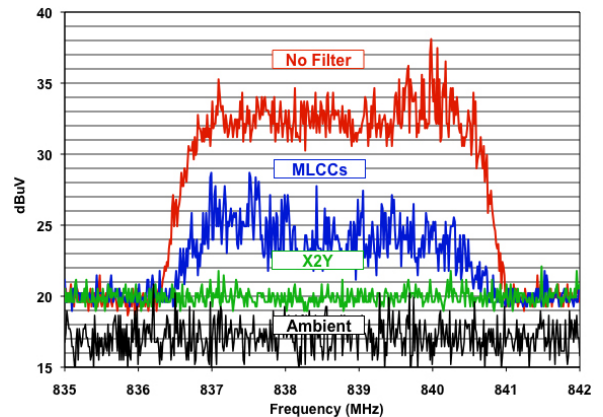

## AMPLIFIER INPUT FILTER EXAMPLE

In this example, a single Johanson X2Y® component was used to filter noise at the input of a DC instrumentation amplifier. This reduced component count by 3-to-1 and costs by over 70% vs. conventional filter components that included 1% film Y-capacitors.

Parameter	X2Y® 10nF	Discrete 10nF, 2 @ 220 pF	Comments
DC offset shift	< 0.1 $\mu$ V	< 0.1 $\mu$ V	Referred to input
Common mode rejection	91 dB	92 dB	

Source: Analog Devices, "A Designer's Guide to Instrumentation Amplifiers (2nd Edition)" by Charles Kitchin and Lew Counts

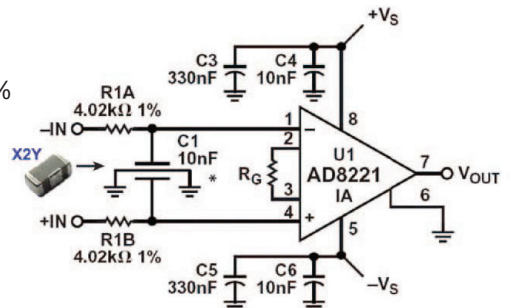

## COMMON MODE CHOKE REPLACEMENT

- Superior High Frequency Emissions Reduction
  - Smaller Sizes, Lighter Weight
  - No Current Limitation
  - Vibration Resistant
  - No Saturation Concerns
- See our website for a detailed application note with component test comparisons and circuit emissions measurements.

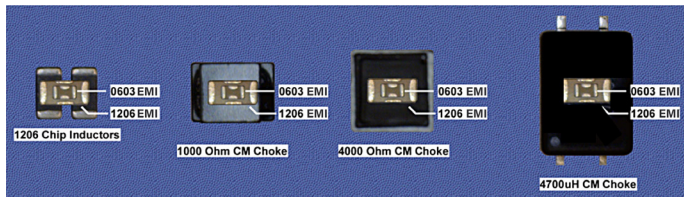

## Measured Common Mode Rejection

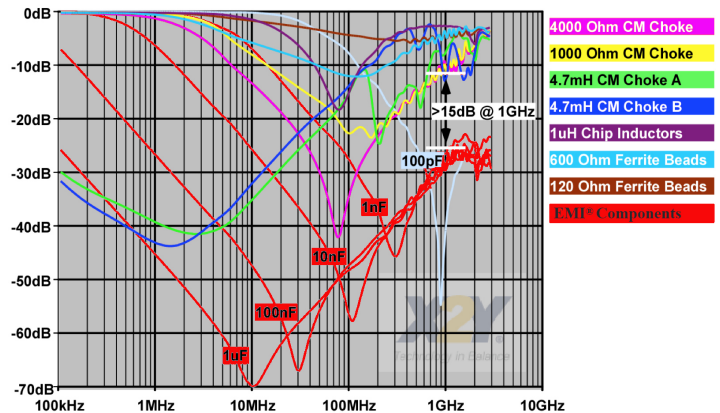

## PARALLEL CAPACITOR SOLUTION

A common design practice is to parallel decade capacitance values to extend the high frequency performance of the filter network. This causes an unintended and often over-looked effect of anti-resonant peaks in the filter networks combined impedance. EMI's very low mounted inductance allows designers to use a single, higher value part and completely avoid the anti-resonance problem. The impedance graph on right shows the combined impedance of a 1nF, 10nF & 100nF MLC in parallel in RED. The MLC networks anti-resonance peaks are nearly 10 times the desired impedance. A 100nF and 47nF EMI are plotted in BLUE and GREEN. (The total capacitance of EMI (Circuit 2) is twice the value, or 200nF and 98nF in this example.) The single EMI is clearly superior to the three paralleled MLCs.

## Decade MLCs vs X2Y Impedance

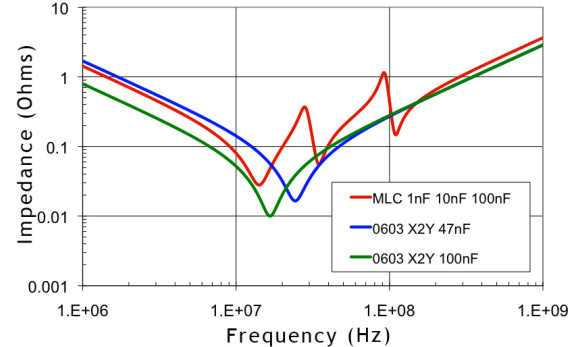

## EMI HIGH PERFORMANCE POWER BYPASS - IMPROVE PERFORMANCE, REDUCE SPACE & VIAS

Actual measured performance of two high performance SerDes FPGA designs demonstrate how a 13 component EMI bypass network significantly out performs a 38 component MLC network.

For more information see <https://johansondielectrics.com/downloads/jdi-emi-stxii.pdf>

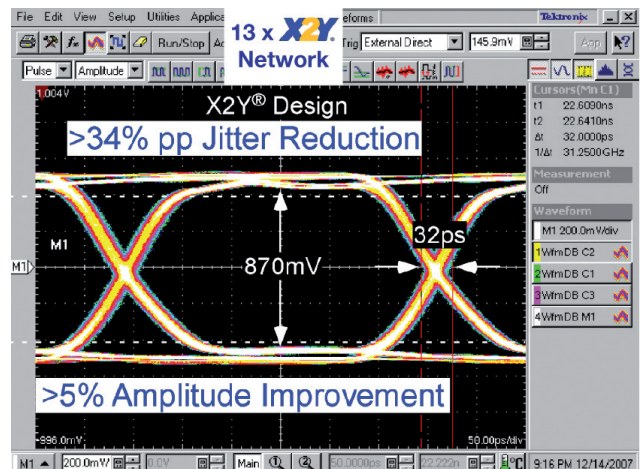
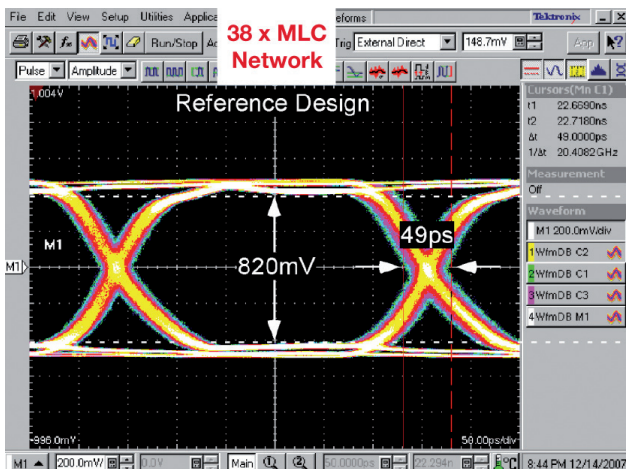
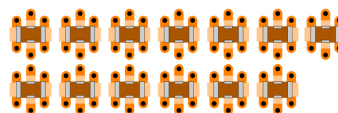
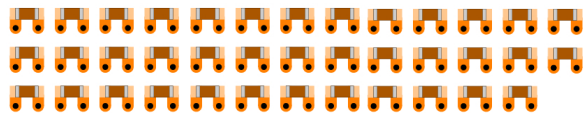

# HIGH TEMPERATURE SURFACE MOUNT MLCCs 200°C

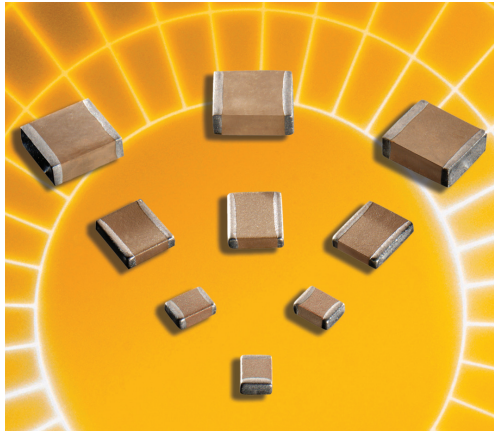

Johanson's high temperature MLCC series exhibit stable performance across an extended operating temperature range of -55°C to +200°C. Both Class I and Class II parts are available with DC voltage ratings of 50, 100 and 200V satisfying a wide range of demanding applications.

## FEATURES

- Stable 200°C Operation
- Compact SMD Chip
- Polyterm® Termination Option
- Sn-Pb Termination Option

## APPLICATIONS

- Deep Hole Drilling Electronics
- High Temperature Modules
- Industrial Equipment
- Automotive • Avionics

## ELECTRICAL CHARACTERISTICS

	NP0	X7R
OPERATING RANGE:	-55 to +200°C	-55 to +200°C
TEMPERATURE COEFFICIENT:	0±30ppm/°C (-55to+125°C)	0±15% (-55to+125°C)
200°C CAP. DROP:	-0.5% max.	-45% max.
DISSIPATION FACTOR:	0.001 (0.1%) max.	0.020 (2.0%) max.
AGING RATE:	None	<1.0% per decade
INSULATION RESISTANCE:	25°C IR >100GΩ or 1000ΩF (whichever is less)	
WITHSTANDING VOLTAGE:	2.5 X WVDC for ratings ≤ 200 VDC 1.5 X WVDC for ratings 201-500 VDC	
TEST CONDITIONS:	C > 100 pF; 1kHz ±50Hz; 1.0±0.2 VRMS C ≤ 100 pF; 1Mhz ±50kHz; 1.0±0.2 VRMS	

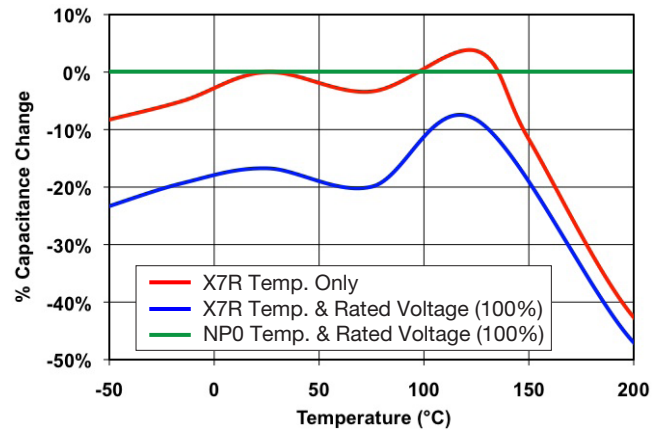





## MECHANICAL CHARACTERISTICS

			RATED VOLTAGE	NP0 DIELECTRIC		X7R DIELECTRIC	
				MINIMUM	MAXIMUM	MINIMUM	MAXIMUM
T07/0402	Inches (mm)	L	25 VDC	10 pF	270 pF	100 pF	4700 pF
		W	50 VDC	10 pF	120 pF	100 pF	1500 pF
		T	100 VDC	10 pF	82 pF	10 pF	390 pF
		E/B	200 VDC	10 pF	50 pF	10 pF	100 pF
T14/0603	Inches (mm)	L	25 VDC	10 pF	820 pF	1000 pF	0.022 μF
		W	50 VDC	10 pF	330 pF	1000 pF	0.010 μF
		T	100 VDC	10 pF	220 pF	100 pF	2200 pF
		E/B	200 VDC	10 pF	120 pF	100 pF	560 pF
T15/0805	Inches (mm)	L	25 VDC	100 pF	2200 pF	1000 pF	0.100 μF
		W	50 VDC	100 pF	1500 pF	1000 pF	0.033 μF
		T	100 VDC	100 pF	1000 pF	1000 pF	0.010 μF
		E/B	200 VDC	10 pF	680 pF	100 pF	2200 pF

# HIGH TEMPERATURE SURFACE MOUNT MLCCs 200°C

## MECHANICAL CHARACTERISTICS

				RATED VOLTAGE	NP0 DIELECTRIC		X7R DIELECTRIC	
					MINIMUM	MAXIMUM	MINIMUM	MAXIMUM
<b>T18/1206</b> 		Inches	(mm)	25 VDC	100 pF	6800 pF	1000 pF	0.220 μF
	L	.125 ±.010	(3.17 ±.25)	50 VDC	100 pF	3300 pF	1000 pF	0.100 μF
	W	.062 ±.010	(1.57 ±.25)	100 VDC	100 pF	2200 pF	1000 pF	0.022 μF
	T	.067 Max.	(1.70)	200 VDC	100 pF	1500 pF	1000 pF	5600 pF
	E/B	.020±.010	(0.51±.25)					
<b>T41/1210</b> 		Inches	(mm)	25 VDC	1000 pF	0.015 μF	0.047 μF	0.470 μF
	L	.125 ±.010	(3.18 ±.25)	50 VDC	1000 pF	5600 pF	0.047 μF	0.220 μF
	W	.095 ±.010	(2.41 ±.25)	100 VDC	100 pF	4700 pF	0.047 μF	0.056 μF
	T	.090 Max.	(2.28)	200 VDC	100 pF	3300 pF	0.0047 μF	0.015 μF
	E/B	.020±.010	(0.51±.25)					
<b>T43/1812</b> 		Inches	(mm)	25 VDC	1000 pF	0.033 μF	0.047 μF	1.000 μF
	L	.175 ±.010	(4.45 ±.25)	50 VDC	1000 pF	0.012 μF	0.047 μF	0.470 μF
	W	.125 ±.010	(3.17 ±.25)	100 VDC	1000 pF	0.010 μF	0.047 μF	0.180 μF
	T	.110 Max.	(2.80)	200 VDC	1000 pF	8200 pF	0.047 μF	0.047 μF
	E/B	.025±.015	(0.64±.38)					
<b>T49/1825</b> 		Inches	(mm)	25 VDC	1000 pF	0.033 μF	0.10 μF	2.200 μF
	L	.180 ±.010	(4.57 ±.25)	50 VDC	1000 pF	0.027 μF	0.10 μF	1.000 μF
	W	.250 ±.010	(6.35 ±.25)	100 VDC	1000 pF	0.022 μF	0.10 μF	0.560 μF
	T	.140 Max.	(3.56)	200 VDC	1000 pF	0.018 μF	0.10 μF	0.150 μF
	E/B	.025±.015	(0.64±.38)					
<b>T48/2225</b> 		Inches	(mm)	25 VDC	1000 pF	0.100 μF	0.10 μF	3.300 μF
	L	.225 ±.010	(5.72 ±.25)	50 VDC	1000 pF	0.039 μF	0.10 μF	1.500 μF
	W	.255 ±.015	(6.48 ±.38)	100 VDC	1000 pF	0.033 μF	0.10 μF	0.820 μF
	T	.160 Max.	(4.06)	200 VDC	1000 pF	0.022 μF	0.10 μF	0.220 μF
	E/B	.025±.015	(0.64±.38)					

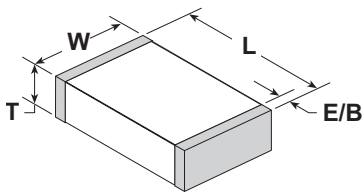

See page 81 for additional dielectric specifications.

## HOW TO ORDER 200°C MLCCs

P/N written: 500T14W103KV4E

500	T14	W	103	K	V	4	E
VOLTAGE	SIZE	DIELECTRIC	CAPACITANCE	TOLERANCE	TERMINATION	MARKING	PACKING
250 = 25 V 500 = 50 V 101 = 100 V 201 = 200 V	T07 = 0402 T14 = 0603 T15 = 0805 T18 = 1206 T41 = 1210 T43 = 1812 T49 = 1825 T48 = 2225	N = NP0 W = X7R	1st two digits are significant; third digit denotes number of zeros.  102 = 1000 pF 103 = 0.01 μF 104 = 0.10 μF	<b>NP0</b> J = ± 5% K = ± 10%  <b>X7R</b> K = ± 10% M = ± 20%	V = Ni Barrier w/ 100% Sn Plating (150°C) T = Ni Barrier w/ 95%Sn/5%Pb Plating (150°C) E = Ni Barrier w/ 100% Sn Plating (180°C) P = Palladium Silver Pd-Ag (200°C)	4 = Unmarked (Not available)	E = Embossed 7" T = Punched 7"  No code = bulk  Tape specs. per EIA RS481



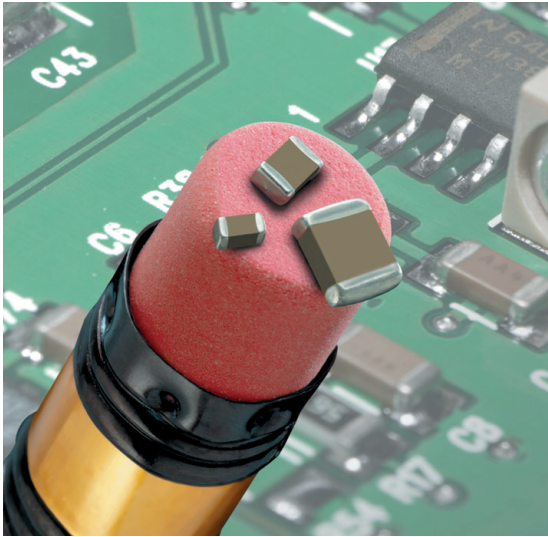

TANCERAM® chip capacitors can replace tantalum capacitors in many applications and offer several key advantages over traditional tantalums. Because TANCERAM® capacitors exhibit extremely low ESR, equivalent circuit performance can often be achieved using considerably lower capacitance values. Low DC leakage reduces current drain, extending the battery life of portable products. TANCERAM® high DC breakdown voltage ratings offer improved reliability and eliminate large voltage de-rating common when designing with tantalums.

## ADVANTAGES

- Low ESR
- Higher Surge Voltage
- Reduced CHIP Size
- Higher Insulation Resistance
- Low DC Leakage
- Non-polarized Devices
- Improved Reliability
- Higher Ripple Current

## APPLICATIONS

- Switching Power Supply Smoothing (Input/Output)
- DC/DC Converter Smoothing (Input/Output)
- Backlighting Inverters
- General Digital Circuits

Typical ESR Comparison

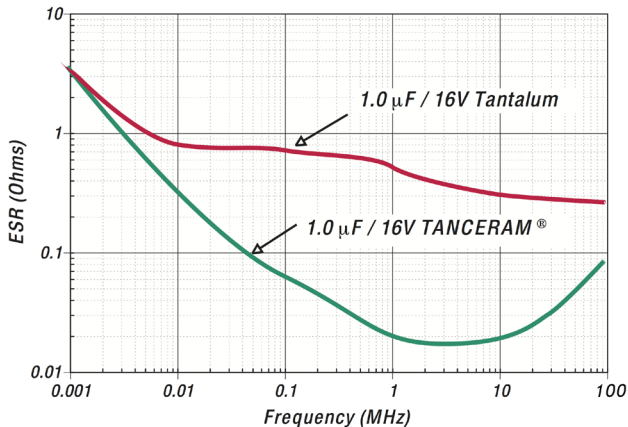

Typical Breakdown Voltage Comparison

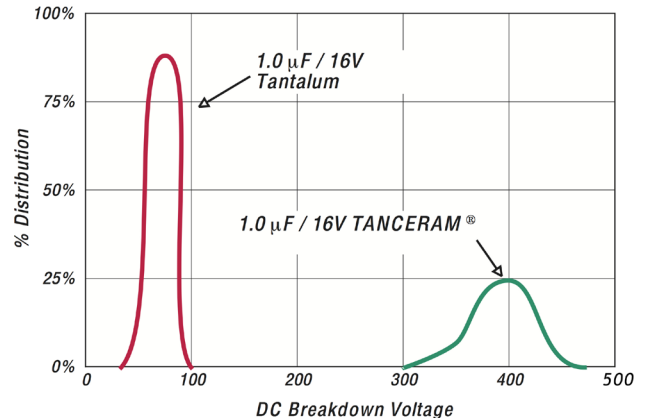

## HOW TO ORDER TANCERAM®

Part number written: 100R15X106MV4E

**100**  
VOLTAGE  
6R3 = 6.3 V  
100 = 10 V  
160 = 16 V  
250 = 25 V  
500 = 50 V  
101 = 100 V

**R15**  
SIZE  
See Chart

**X**  
DIELECTRIC  
W = X7R  
X = X5R

**106**  
CAPACITANCE  
1st two digits are significant; third digit denotes number of zeros.  
105 = 1.00 µF  
476 = 47.0 µF  
107 = 100 µF

**M**  
TOLERANCE  
K = ±10%  
M = ±20%

**V**  
TERMINATION  
V = Nickel Barrier with 100% Tin Plating (Matte)  
T = SnPb\*  
(\*available on select parts)

**4**  
MARKING  
4 = Unmarked

**E**  
PACKING  
Code Type Reel  
E Plastic 7"  
T Paper 7"  
Tape specifications conform to EIA RS481



## CAPACITANCE SELECTION

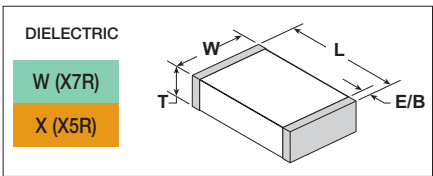

EIA / JDI	INCHES	(mm)	VDC	1.0 μF	1.5 μF	2.2 μF	3.3 μF	4.7 μF	10 μF	22 μF	47 μF	100 μF	220 μF
0201 R05 -	L .024 ±.001 W .011 ±.001 T .013 Max. EB .004 Min.	(0.60 ±.03) (0.28 ±.03) (0.33 Max.) (0.10 Min.)	Dielectric	W X	W X	W X	W X	W X	W X	W X	W X	X	X
			10										
			6.3										
			4										
			35										
0402 R07 -	L .039 ±.002 W .020 ±.002 T .022 Max. EB .002 Min.	(0.99 ±.05) (0.51 ±.05) (0.55 Max.) (0.05 Min.)	35										
			25										
			16										
			10										
			6.3										
0603 R14 -	L .063 ±.004 W .031 ±.004 T .037 Max. EB .006 Min.	(1.60 ±.10) (0.79 ±.10) (0.93 Max.) (0.15 Min.)	50										
			35										
			25										
			16										
			10										
0805 R15 -	L .079 ±.012 W .049 ±.008 T .057 Max. EB .008 Min.	(2.01 ±.30) (1.24 ±.20) (1.44 Max.) (0.20 Min.)	50										
			35										
			25										
			16										
			10										
1206 R18 -	L .126 ±.012 W .063 ±.008 T .071 Max. EB .010 Min.	(3.20 ±.30) (1.60 ±.20) (1.80 Max.) (0.25 Min.)	50										
			35										
			25										
			16										
			10										
1210 S41 -	L .126 ±.012 W .098 ±.012 T .106 Max. EB .012 Min.	(3.20 ±.30) (2.49 ±.30) (2.69 Max.) (0.30 Min.)	50										
			35										
			25										
			16										
			10										
1812 S43 -	L .177 ±.016 W .126 ±.012 T .118 Max. EB .012 Min.	(4.50 ±.41) (3.20 ±.30) (2.99 Max.) (0.30 Min.)	50										
			25										
2220 S47 -	L .220 ±.016 W .197 ±.016 T .118 Max. EB .012 Min.	(5.59 ±.41) (3.20 ±.30) (2.99 Max.) (0.30 Min.)	50										
			25										

"K" OR "M" TOLERANCE, 0201 ONLY AVAILIABLE IN M ONLY "M" TOLERANCE

### ELECTRICAL CHARACTERISTICS

DIELECTRIC:	X7R	X5R
TEMPERATURE COEFFICIENT:	±15% (-55 to +125°C)	±15% (-55 to +85°C)
DISSIPATION FACTOR:	For ≥ 50 VDC: 5% max. For ≤ 35 VDC: 10% max.	For ≥ 50 VDC: 5% max. For ≤ 35 VDC: 10% max.
INSULATION RESISTANCE (MIN. @ 25°C, WVDC)	100 ΩF or 10 GΩ, whichever is less	
DIELECTRIC STRENGTH:	2.5 X WVDC, 25°C, 50mA max.	
TEST CONDITIONS:	Capacitance values ≤ 10 μF: 1.0kHz±50Hz @ 1.0±0.2 Vrms Capacitance values > 10 μF: 120Hz±10Hz @ 0.5V±0.1 Vrms	
OTHER:	See page 81 for additional dielectric specifications.	



# SURFACE MOUNT MLCCs 10 - 200 VDC

CASE SIZE			Voltage	AVAILABLE CAPACITANCE CODE																									
JDI	Inches	(mm)		0R5	XRX	100	120	150	180	220	270	330	390	470	560	680	820	101	121	151	181	221	271	331	391	471	561	681	821
R05	0201	(0603) L .024 ±.001 W .012 ±.001 T .012 ±.001 EB .006 ±.002 (0.60 ±.03) (0.30 ±.03) (0.30 ±.03) (0.15±.05)	25V	█																									
			16V	█											█														
			10V	█											█							█							
			50V	█											█														
R07	0402	(1005) L .040 ±.004 W .020 ±.004 T .025 Max. EB .008 ±.004 (1.02 ±.10) (0.51 ±.10) (0.64) (0.20±.10)	50V	█											█														
			25V	█											█														
			16V	█											█														
			10V	█											█														
R14	0603	(1608) L .063 ±.008 W .032 ±.008 T .035 Max. EB .010±.005 (1.60 ±.20) (0.81 ±.20) (0.89) (.25±.13)	200V	█											█														
			100V	█											█														
			50V	█											█														
			25V	█											█														
			16V	█											█														
R15	0805	(2012) L .080 ±.010 W .050 ±.010 T .050 Max. EB .020±.010 (2.03 ±.25) (1.27 ±.25) (1.27) (0.51±.25 )	200V	█											█														
			100V	█											█														
			50V	█											█														
			25V	█											█														
			16V	█											█														
R18	1206	(3216) L .125 ±.010 W .062 ±.010 T .050 Max. EB .020 ±.010 (3.17 ±.25) (1.57 ±.25) (1.27) (0.51 ±.25)	200V	█											█														
			100V	█											█														
			50V	█											█														
			25V	█											█														
S41	1210	(3224) L .125 ±.010 W .095 ±.010 T .065 Max. EB .020 ±.010 (3.18 ±.25) (2.41 ±.25) (1.65) (0.51 ±.25)	200V												NP0														
			100V												X7R														
			50V												X5R														
			25V																										
			16V																										
S43	1812	(4532) L .175 ±.010 W .125 ±.010 T .085 Max. EB .025 ±.015 (4.45 ±.25) (3.17 ±.25) (2.16) (0.64 ±.38)	200V																										
			100V																										
			50V																										
			25V																										

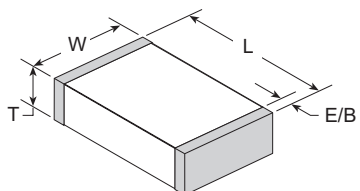

## HOW TO ORDER - SURFACE MOUNT MLCC

Part number written: 100R07W104KV4E

<b>100</b>	<b>R 07</b>	<b>W</b>	<b>104</b>	<b>K</b>	<b>V</b>	<b>4</b>	<b>E</b>
<b>VOLTAGE</b>	<b>SERIES/SIZE</b>	<b>DIELECTRIC</b>	<b>CAPACITANCE</b>	<b>TOLERANCE</b>	<b>TERMINATION</b>	<b>MARKING</b>	<b>PACKING</b>
100 = 10 V DC 160 = 16 V DC 250 = 25 V DC 500 = 50 V DC 101 = 100 V DC 201 = 200 V DC	R05 = 0201 R07 = 0402 R14 = 0603 R15 = 0805 R18 = 1206 S41 = 1210 S43 = 1812	N = NP0 W = X7R X = X5R	1st two digits are significant; third digit denotes number of zeros, R = decimal.  5R6 = 5.6 pF 100 = 10 pF 102 = 1,000 pF 474 = 0.47 μF	* B = ± 0.10 pF * C = ± 0.25 pF * D = ± 0.50 pF F = ± 1 % G = ± 2 % J = ± 5 % K = ± 10 % M = ± 20 %  *Values < 10 pF only	V = Nickel Barrier with 100% Tin Plating (Matte)  T = SnPb	3 = Special 4 = Unmarked 6 = EIA Code*  *Not available on sizes ≤ 0402	E = Embossed 7" T = Punched 7" U = Embossed 13" R = Punched 13" No code = bulk  Tape specifications on page 48. Not all tape styles are available on all parts.



# SURFACE MOUNT MLCCs 10 - 200 VDC

AVAILABLE CAPACITANCE CODE																							Voltage	CASE SIZE													
122	152	182	222	272	332	392	472	562	822	103	123	153	183	223	273	333	473	563	683	823	104	224			334	474	105	225	335	475	106	476	107				
																																			25V	0201 R05	
																																		16V			
																																		10V			
																																			50V	0402 R07	
																																		25V			
																																		16V			
																																			10V		
																																			200V	0603 R14	
																																		100V			
																																		50V			
																																			25V		
																																			16V	0805 R15	
																																			200V		
																																			100V		
																																			50V		
																																				25V	1206 R18
																																			16V		
																																			200V		
																																				100V	
																																				50V	1210 S41
																																			25V		
																																			16V		
																																				200V	1812 S43
																																			100V		
																																			50V		
																																				25V	

See Tanceram High Capacitance Series for values  $\geq 1.0\mu\text{F}$

## ELECTRICAL CHARACTERISTICS

Please refer to page 81 of the catalog or [www.johanson-dielectrics.com](http://www.johanson-dielectrics.com)



# STACKED SMPS CERAMIC CAPACITORS



Stacked Switch-Mode ceramic capacitors feature large capacitance values and exhibit low ESR (equivalent series resistance) and low ESL (equivalent series inductance) making them well suited for high power and high frequency applications where tantalum or aluminum electrolytic capacitors may not be suitable. The P-Series feature mechanical and pin-out configurations per DSCC 87106 and 88011 drawings while the E-Series feature mechanical and pin-out configurations more common in European design applications.

## KEY FEATURES

- P-Series Approved to DSCC Drawings 87106 & 88011 MIL-PRF-49470
- New T-Series 200°C for downhole tools and aircraft engine control applications.
- E-Series Common European Lead Styles available to MIL-PRF-49470 requirements.
- NP0 & X7R Dielectrics, 50 to 500 VDC Ratings
- Low ESR / Low ESL, Ideal for SMPS Filtering Applications
- Custom Sizes, Voltages, and Values Available

## CASE SIZE

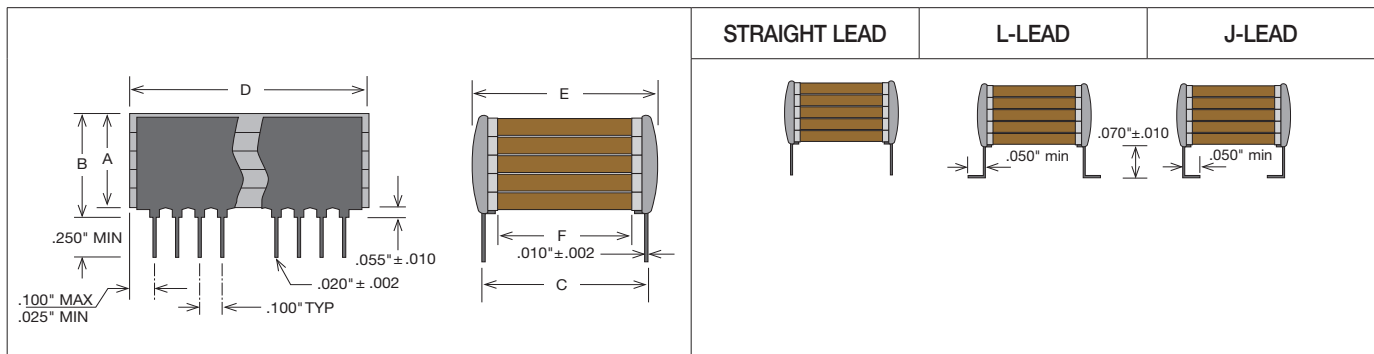

## HOW TO ORDER STACKED SMPS

Part number written: 201P03W275KJ4H

201	P03	W	275	K	J	4	H
<b>VOLTAGE</b>	<b>SIZE</b>	<b>DIELECTRIC</b>	<b>CAPACITANCE</b>	<b>TOLERANCE</b>	<b>TERMINATION</b>	<b>MARKING</b>	<b>PACKING</b>
500 = 50 V 101 = 100 V 201 = 200 V 501 = 500 V	See Chart	N = NP0 B = BX W = X7R	1st two digits are significant; third digit denotes number of zeros. 101 = 100 pF 102 = 1000 pF 103 = 0.01 μF 105 = 1.00 μF	J = ±5% K = ±10% L = ±15% M = ±20% N = ±30% Z = +80% -20% P = +100% -0%	J = "J" Leads (formed in) K = "J" Leads with reduced height of .045" ±.010" L = "L" Leads (formed out) M = "L" Leads with reduced height of .045" ±.010" N = Straight Lead	4 = Standard 3 = Specified	T = Tape and Reel H = High Reliability testing per customer requirements S = Special Part



# STACKED SMPS CERAMIC CAPACITORS

## *P-SERIES DSCC STYLE X7R CAPACITANCE / VOLTAGE SELECTION*

CASE SIZE	CHIP LAYERS	LEADS /SIDE	MECHANICAL SIZE RANGE (IN.)			X7R MAX CAPACITANCE (μF)			
			LENGTH (D)	WIDTH (E)	TMAX (B)	50V	100V	200V	500V
P05	1	3	0.275	0.300	.185	3.0	2.2	1.0	0.50
P55	5				.715	15	11	5.0	2.5
P04	1	4	0.425	0.440	.185	9.0	6.5	3.0	1.5
P54	5				.715	45	32	15	7.5
P03	1	10	1.075	0.500	.185	28	20	9.5	4.7
P53	5				.715	140	100	47	23
P01	1	20	2.075	0.500	.185	50	40	19	9.4
P51	5				.715	250	200	95	46
P02	1	15	1.535	0.870	.185	75	55	25	14
P52	5				.715	370	270	125	70
P06	1	20	2.075	1.350	.185	160	110	50	25
P56	5				.715	800	550	250	125

Please refer to our website for complete offering including NP0 & BX capacitance ranges.

## *NEW 200°C T-SERIES CAPACITANCE / VOLTAGE SELECTION*

CASE SIZE	CHIP LAYERS	LEADS /SIDE	MECHANICAL SIZE RANGE (IN.)			MAX CAPACITANCE (μF)		
			LENGTH (D)	WIDTH (E)	TMAX (B)	50V	100V	200V
T05	1	3	0.275	0.300	.185	1.20	0.68	0.33
T55	5				.715	5.60	3.30	1.50
T04	1	4	0.425	0.440	.185	2.70	1.50	0.82
T54	5				.715	15.0	8.20	3.90
T03	1	10	1.075	0.500	.185	10.0	5.60	2.70
T53	5				.715	47.0	27.0	12.0

Please refer to our website for complete offering including NP0 capacitance ranges.  
or contact our technical team @ <https://johansondielectrics.com/ask-a-question>

## *E-SERIES EUROPEAN STYLE X7R CAPACITANCE / VOLTAGE SELECTION*

CASE SIZE	CHIP LAYERS	LEADS /SIDE	MECHANICAL SIZE RANGE (MM)			X7R MAX CAPACITANCE (μF)			
			LENGTH (D)	WIDTH (E)	TMAX (B)	50V	100V	200V	500V
E24	1	3	8.7	9.2	3.8	5.0	4.0	2.5	1.0
E54	4				14.8	20	16	10	4.0
E26	1	5	13.6	14.9	3.	16	12	7.5	3.3
E56	4				14.8	64	48	30	13
E21	1	6	16.6	21.6	3.8	30	22	14	6.0
E51	4				14.8	120	88	56	24
E28	1	14	38.2	12.0	3.8	35	25	16	7.0
E58	4				14.8	140	100	64	28
E29	1	14	40.6	24.0	3.8	75	50	35	16
E59	4				14.8	300	200	140	64

Please refer to our website for complete offering including NP0 & BX capacitance ranges.



# MINI-SWITCH-MODE® CAPACITORS



JDI's Mini Switch-Mode® ceramic capacitors combine the advantages of high capacitance found in tantalum capacitors with very low ESR performance of ceramic capacitors. The “J” and “L” lead configurations replace 1825 and 2225 SMT chips to provide stress relief and prevent cracking due to thermal cycling or mechanical board flexing. Another plus of the J-lead style is that this configuration allows use of the same solder lands as the SMT chips. See the Stacked Switch-Mode section for larger values. See also the Technical Notes on soldering and handling and suggested solder lands.

## FEATURES

- High Capacitance, Small Size
- Low ESR/ESL
- Leadframe reduces thermal & mechanical stress due to board flexure and TCE mismatch

## APPLICATIONS

- DC-DC Converters
- Power Supply Input & Output Filters

## CAPACITANCE SELECTION

SIZE CODE	EIA CHIP SIZE	NP0 Max Capacitance (uF)					X7R Max Capacitance (uF)				
		25V	50V	100V	200V	500V	25V	50V	100V	200V	500V
P09	1825	0.056	0.047	0.039	0.027	0.018	1.5	1.2	0.75	0.56	0.27
P29	1825	0.11	0.094	0.078	0.054	0.036	3.0	2.4	1.5	1.1	0.54
P39	1825	0.16	0.14	0.11	0.081	0.054	4.5	3.6	2.2	1.6	0.81
P49	1825	0.22	0.18	0.15	0.10	0.07	6.0	4.8	3.0	2.2	1.0
P08	2225	0.068	0.056	0.047	0.033	0.027	2.7	2.2	1.5	1.2	0.39
P28	2225	0.13	0.11	0.094	0.066	0.054	5.4	4.4	3.0	2.4	0.78
P38	2225	0.20	0.16	0.14	0.10	0.081	8.1	6.6	4.5	3.6	1.1
P48	2225	0.27	0.22	0.18	0.13	0.10	10	8.8	6.0	4.8	1.5

# MINI-SWITCH-MODE® CAPACITORS

## CASE SIZE

DIMENSIONS APPLICABLE TO ALL SIZES:																		
	IN.	MM	P08		P09		P28		P29		P38		P39		P48		P49	
	IN.	MM	IN.	MM	IN.	MM	IN.	MM	IN.	MM	IN.	MM	IN.	MM	IN.	MM	IN.	MM
H ± .010	.070	1.78																
C TYP.	.100	2.54																
P ± .015	.065	1.65																
<b>L MAX</b>	.280	7.11	0.24	6.1	0.28	7.11	0.24	6.1	0.28	7.11	0.24	6.1	0.28	7.11	0.24	6.1	0.24	6.1
<b>W MAX</b>	.270	6.86	0.27	6.86	0.27	6.86	0.27	6.86	0.27	6.86	0.27	6.86	0.27	6.86	0.27	6.86	0.27	6.86
<b>T MAX</b>	.095	2.41	0.095	2.41	0.19	4.83	0.19	4.83	0.285	7.24	0.285	7.24	0.38	9.65	0.38	9.65	0.38	9.65

Note: J-Lead and L-Lead options are available on all sizes above

## ELECTRICAL CHARACTERISTICS

DIELECTRIC:	NP0	X7R
TEMPERATURE COEFFICIENT:	0 ±30ppm/°C (-55 to +125°C)	±15% (-55 to +125°C)
DISSIPATION FACTOR:	0.1% max.	2.5% max.
AGING:	None	-2.5% per decade hour
INSULATION RESISTANCE (MIN. @ 25°C, WVDC)	1000 ΩF or 100 GΩ, whichever is less	500 ΩF or 50 GΩ, whichever is less
DIELECTRIC STRENGTH:	For 500V Ratings: 750VDC, 25°C, 50mA max For 200V Ratings: 2xWVDC, 25°C, 50mA max For 25-100V Ratings: 2.5xWVDC, 25°C, 50mA max	
TEST CONDITIONS:	1kHz ±50Hz; 1.0±0.2 VRMS	
OTHER:	See page 81 for additional dielectric specifications.	

## HOW TO ORDER - MINI SWITCHMODE®

Part number written: 500P28W395KJ4U

500	P28	W	395	K	J	4	U
VOLTAGE	SIZE	DIELECTRIC	CAPACITANCE	TOLERANCE	TERMINATION	MARKING	PACKING
250 = 25 V 500 = 50 V 101 = 100 V 201 = 200 V 501 = 500 V	See Chart	N = NP0 W = X7R	1st two digits are significant; third digit denotes number of zeros. 103 = 0.01 μF 105 = 1.0 μF 106 = 10 μF	J = ±5% K = ±10% M = ±20% Z = +80% -20%	J = "J" Leads (formed in) L = "L" Leads (formed out)	3 = Standard 4 = Unmarked	U = Tape and Reel 16mm, 13" Reel NONE = Bulk pack H = High Reliability testing per customer requirements S = Special Part



# BME MINI-SWITCH-MODE® CAPACITORS



This new series of miniature switchmode power supply filter capacitors uses BME (Base Metal Electrode) construction to achieve 300-400% capacitance increases and component size reductions compared to their PME (Precious Metal Electrode) counterparts per the comparison examples below.

## BME Size / Capacitance Comparison

Technology	Chips	Volts	Max. Cap.
PME	1x 1825	50V	1.2 $\mu$ F
<b>BME</b>	<b>1x 1812</b>	<b>50V</b>	<b>4.7<math>\mu</math>F</b>
PME	2x 2225	100V	4.4 $\mu$ F
<b>BME</b>	<b>2x 2220</b>	<b>100V</b>	<b>10<math>\mu</math>F</b>

## FEATURES

- High Capacitance, Small Size
- Low ESR/ESL
- Leadframe reduces thermal & mechanical stress due to board flexure and TCE mismatch
- Green / ROHS Compliant

## APPLICATIONS

- DC-DC Converters
- Power Supply Input & Output Filters
- High Capacitance Applications Where Increased Reliability is Required

## CAPACITANCE / VOLTAGE

CAPACITANCE RATING	DC VOLTAGE RATING	SIZE P0A 1812 SINGLE STACK		SIZE P07 2220 SINGLE STACK		SIZE P2A 1812 DOUBLE STACK		SIZE P27 2220 DOUBLE STACK		
		IN.	MM	IN.	MM	IN.	MM	IN.	MM	
2.2 $\mu$ F	100V	101P0AW225MJ4U+RC								
4.7 $\mu$ F	50V	500P0AW475MJ4U+RC								
4.7 $\mu$ F	100V			101P07W475MJ4U+RC		101P2AW475MJ4U+RC				
10 $\mu$ F	50V			500P07W106MJ4U+RC		500P2AW106MJ4U+RC				
10 $\mu$ F	100V							101P27W106MJ4U+RC		
22 $\mu$ F	50V							500P27W226MJ4U+RC		
Dimensions Applicable to specific sizes:	L MAX:	0.217	5.5	0.256	6.5	0.217	5.5	0.256	6.5	
	W MAX:	0.157	4.0	0.217	5.5	0.157	4.0	0.217	5.5	
	H MAX:	0.118	3.0	0.118	3.0	0.236	6.0	0.236	6.0	
Dimensions Applicable to all sizes:										
	IN.	MM								
H1 TYP.	.059	1.50								
C TYP.	.100	2.54								
P1 TYP.	.020	0.50								
P2 $\pm$ 0.02	.065	1.65								

## CASE SIZE / PART NUMBER

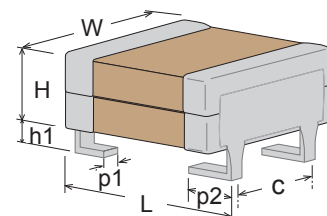
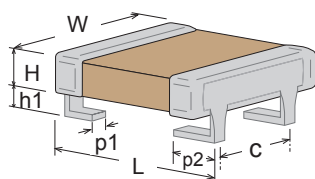



## TYPICAL APPLICATION: DC-DC CONVERTER INPUT & OUTPUT FILTERING

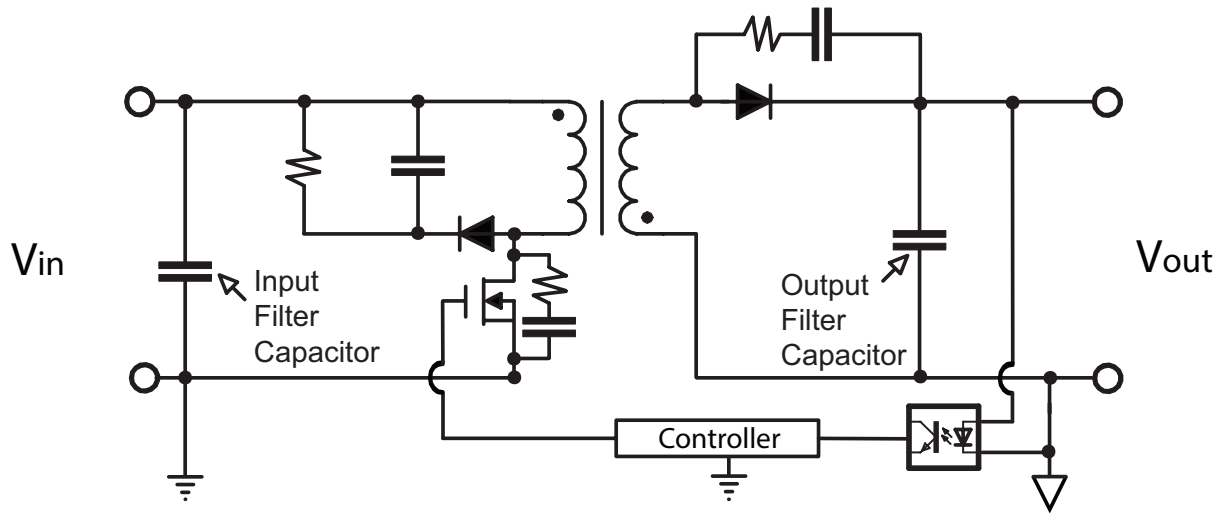

### ELECTRICAL CHARACTERISTICS

OPERATING RANGE:	-55 to +125°C
TEMPERATURE COEFFICIENT:	X7R, ±15%
DISSIPATION FACTOR:	0.020 (2.0%) max.
AGING RATE:	<2.5% per decade
INSULATION RESISTANCE:	25°C IR >100GΩ or 1000 ΩF whichever is less
WITHSTANDING VOLTAGE:	2.5 X WVDC for 50 VDC 2.0 X WVDC for 100 VDC
TEST CONDITIONS:	1kHz ±50Hz; 1.0±0.2 VRMS, 25°C

BME MINI SWITCHMODE TEMPERATURE COEFFICIENT

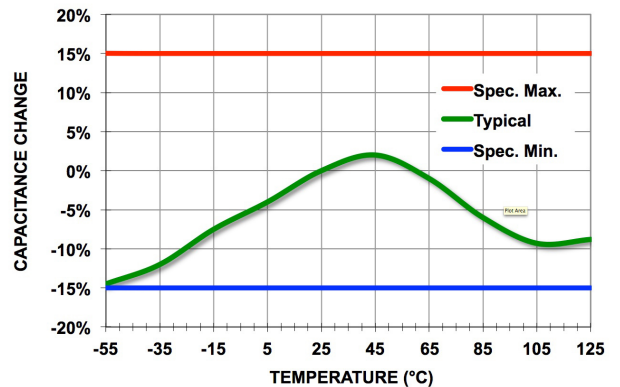

### HOW TO ORDER - BME MINI SWITCH-MODE®

Part number written: 500P07W106MJ4U+RC

500	P07	W	106	M	J	4	U	+RC
VOLTAGE	SIZE	DIELECTRIC	CAPACITANCE	TOLERANCE	TERMINATION	MARKING	PACKING	ROHS CODE
500 = 50 V 101 = 100 V	See Chart	W = X7R	1st two digits are significant; third digit denotes number of zeros. 225 = 2.2 μF 106 = 10 uF	M = ±20%	J = "J" Leads (formed in)	4 = Unmarked	U = Embossed Tape 13" Reel per EIA RS481	+RC = RoHS Compliant



# SWITCH-MODE RADIAL LEADED CAPACITORS

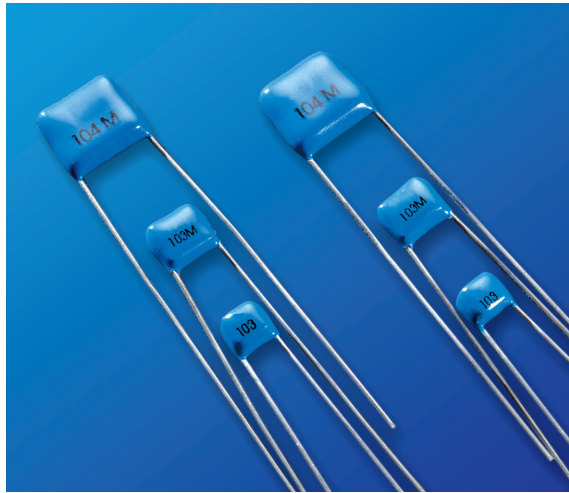





## KEY FEATURES

- Rated Working Voltages from 25 to 500 VDC
- Rugged Epoxy Coating Offers Increased Protection
- Hi-Rel Screened Versions Available
- Custom Sizes, Voltages, and Values Available

## ADVANTAGES





- Power Supplies
- Voltage Multipliers
- Data Isolation
- Surge Protection
- Industrial Control Circuits
- Custom Applications

## CASE SIZE

		IN.	(MM)	RATED VOLTAGE	NP0 CAPACITANCE (MAX.)		X7R CAPACITANCE (MAX.)	
					VALUE	CODE	VALUE	CODE
 <b>H03</b>	W	.300 max.	(7.62 max.)	25 VDC	.070 $\mu$ F	703	2.00 $\mu$ F	205
	H	.300 max.	(7.62 max.)	50 VDC	.060 $\mu$ F	603	1.60 $\mu$ F	165
	T	.200 max.	(5.08 max.)	100 VDC	.050 $\mu$ F	503	1.10 $\mu$ F	115
	S	.200 nom.	(5.08 nom.)	200 VDC	.040 $\mu$ F	403	.730 $\mu$ F	734
	LD	.020 nom.	(.510 nom.)	500 VDC	.020 $\mu$ F	203	.250 $\mu$ F	254
					25 VDC	.120 $\mu$ F	124	5.10 $\mu$ F
 <b>H04</b>	W	.400 max.	(10.2 max.)	50 VDC	.100 $\mu$ F	104	4.10 $\mu$ F	415
	H	.400 max.	(10.2 max.)	100 VDC	.082 $\mu$ F	823	2.70 $\mu$ F	275
	T	.200 max.	(5.08 max.)	200 VDC	.050 $\mu$ F	503	1.80 $\mu$ F	185
	S	.200 nom.	(5.08 nom.)	500 VDC	.030 $\mu$ F	303	.670 $\mu$ F	674
	LD	.020 nom.	(.510 nom.)	25 VDC	.240 $\mu$ F	244	8.70 $\mu$ F	875
					50 VDC	.200 $\mu$ F	204	7.20 $\mu$ F
 <b>H05</b>	W	.500 max.	(12.7 max.)	100 VDC	.180 $\mu$ F	184	4.80 $\mu$ F	485
	H	.500 max.	(12.7 max.)	200 VDC	.110 $\mu$ F	114	3.30 $\mu$ F	335
	T	.200 max.	(5.08 max.)	500 VDC	.070 $\mu$ F	703	1.10 $\mu$ F	115
	S	.400 nom.	(10.2 nom.)	25 VDC	.750 $\mu$ F	754	22.0 $\mu$ F	226
	LD	.025 nom.	(.635 nom.)	50 VDC	.620 $\mu$ F	624	17.0 $\mu$ F	176
					100 VDC	.560 $\mu$ F	564	13.0 $\mu$ F
 <b>H06</b>	W	.870 max.	(22.1 max.)	200 VDC	.360 $\mu$ F	364	8.00 $\mu$ F	805
	H	.600 max.	(15.2 max.)	500 VDC	.240 $\mu$ F	244	2.90 $\mu$ F	295
	T	.200 max.	(5.08 max.)	25 VDC	.750 $\mu$ F	754	22.0 $\mu$ F	226
	S	.790 nom.	(20.1 nom.)	50 VDC	.620 $\mu$ F	624	17.0 $\mu$ F	176
	LD	.032 nom.	(.813 nom.)	100 VDC	.560 $\mu$ F	564	13.0 $\mu$ F	136
					200 VDC	.360 $\mu$ F	364	8.00 $\mu$ F

See page 81 for additional dielectric specifications.

# SWITCH-MODE RADIAL LEADED CAPACITORS

CASE SIZE		IN.	(MM)	RATED VOLTAGE	NP0 CAPACITANCE (MAX.)		X7R CAPACITANCE (MAX.)	
					VALUE	CODE	VALUE	CODE
 H07	W	1.10 max.	(27.9 max.)	25 VDC	.680 µF	684	35.0 µF	356
	H	.600 max.	(15.2 max.)	50 VDC	.560 µF	564	28.0 µF	286
	T	.200 max.	(5.08 max.)	100 VDC	.470 µF	474	19.0 µF	196
	S	.980 nom.	(24.9 nom.)	200 VDC	.330 µF	334	13.0 µF	136
	LD	.032 nom.	(.813 nom.)	500 VDC	.200 µF	204	4.60 µF	465
					25 VDC	1.20 µF	125	70.0 µF
 H08	W	1.10 max.	(27.9 max.)	50 VDC	1.10 µF	115	56.0 µF	566
	H	.600 max.	(15.2 max.)	100 VDC	.820 µF	824	37.0 µF	376
	T	.350 max.	(8.89 max.)	200 VDC	.470 µF	474	26.0 µF	266
	S	.980 nom.	(24.9 nom.)	500 VDC	.300 µF	304	8.70 µF	875
	LD	.032 nom.	(.813 nom.)					
					25 VDC	.450 µF	454	13.0 µF
 H09	W	.670 max.	(17 max.)	50 VDC	.360 µF	364	10.0 µF	106
	H	.540 max.	(13.7 max.)	100 VDC	.330 µF	334	7.20 µF	725
	T	.200 max.	(5.08 max.)	200 VDC	.240 µF	244	5.00 µF	505
	S	.575 nom.	(14.6 nom.)	500 VDC	.180 µF	184	1.70 µF	175
	LD	.025 nom.	(.635 nom.)					
					25 VDC	1.00 µF	105	38.0 µF
 H10	W	.930 max.	(23.6 max.)	50 VDC	.900 µF	904	30.0 µF	306
	H	.720 max.	(18.3 max.)	100 VDC	.750 µF	754	20.0 µF	206
	T	.250 max.	(6.35 max.)	200 VDC	.470 µF	474	14.0 µF	146
	S	.800 nom.	(20.3 nom.)	500 VDC	.300 µF	304	5.80 µF	585
	LD	.032 nom.	(.813 nom.)					

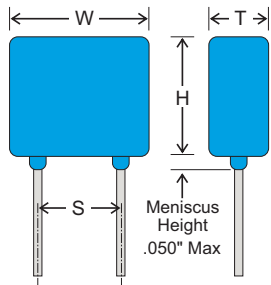

NOTE: Lead lengths are typically 1.25" for orders in bulk packaging. Leads are typically 1.00" for tape and reel packaging. Tape and reel packaging comes in 1000 piece reels.

## HOW TO ORDER SWITCH-MODE RADIALS

Part number written: 201H07W105KQ4

201	H07	W	105	K	Q	4	T
<b>VOLTAGE</b>	<b>SIZE</b>	<b>DIELECTRIC</b>	<b>CAPACITANCE</b>	<b>TOLERANCE</b>	<b>TERMINATION</b>	<b>MARKING</b>	<b>PACKING</b>
250 = 25 V 500 = 50 V 101 = 100 V 201 = 200 V 501 = 500 V	See Chart	N = NP0 W = X7R	1st two digits are significant; third digit denotes number of zeros. 101 = 100 pF 102 = 1000 pF 103 = 0.01 µF 105 = 1.00 µF	J = ± 5% K = ± 10% M = ± 20% Z = +80% -20%	Q = Leaded & Encapsulated	4 = Standard 3 = Specified	T = Tape and Reel H = High Rel Testing per customer requirements S = Special Part



# HIGH VOLTAGE RADIAL LEADED CAPACITORS

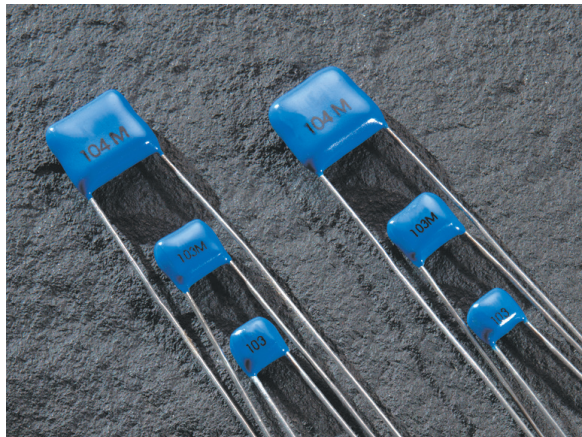





## KEY FEATURES

- Rated Working Voltages from 500 to 5000 VDC
- Rugged Epoxy Coating Offers Increased Protection
- Compact MLC Designs Smaller Than Film or Disc
- NEW 200°C Versions Available for Oil & Geophysical Tool, Aircraft Engine Control Applications
- DSCC Drawing & Other Screened Versions Available

## ADVANTAGES



- Power Supplies
- Voltage Multipliers
- Data Isolation
- Surge Protection
- Industrial Control Circuits
- Custom Applications

## CASE SIZE

		IN.	(MM)	RATED VOLTAGE	NP0 CAPACITANCE (MAX.)		X7R CAPACITANCE (MAX.)	
					VALUE	CODE	VALUE	CODE
 H42	W	0.250 Max	(6.35 Max)	500 VDC	4700 pF	472	.150 µF	154
	H	0.220 Max	(5.59 Max)	1000 VDC	1500 pF	152	.055 µF	553
	T	0.270 Max	(6.86 Max)	2000 VDC	680 pF	681	9000 pF	902
	S	0.170 ±0.03	(4.32 ±0.76)	3000 VDC	330 pF	331	2800 pF	282
	LD	0.025 ±.002	(0.64 ±0.05)	4000 VDC	150 pF	151	630 pF	631
					5000 VDC	100 pF	101	550 pF
 H47	W	0.370 Max	(9.40 Max)	500 VDC	.022 µF	223	.480 µF	484
	H	0.300 Max	(7.62 Max)	1000 VDC	3300 pF	332	.170 µF	174
	T	0.270 Max	(6.86 Max)	2000 VDC	1500 pF	152	.025 µF	253
	S	0.275 ±0.03	(6.99 ±0.76)	3000 VDC	680 pF	681	.011 µF	113
	LD	0.025 ±.002	(0.64 ±0.05)	4000 VDC	330 pF	331	1800 pF	182
					5000 VDC	220 pF	221	940 pF
 H51	W	0.470 Max	(12.0 Max)	500 VDC	.056 µF	563	1.20 µF	125
	H	0.400 Max	(10.2 Max)	1000 VDC	4700 pF	472	.450 µF	454
	T	0.320 Max	(8.13 Max)	2000 VDC	3300 pF	332	.094 µF	943
	S	0.375 ±0.03	(9.53 ±0.76)	3000 VDC	1500 pF	152	.043 µF	433
	LD	0.025 ±.002	(0.64 ±0.05)	4000 VDC	1000 pF	102	.010 µF	103
					5000 VDC	470 pF	471	4900 pF
 H62	W	0.570 Max	(14.5 Max)	500 VDC	.100 µF	104	2.20 µF	225
	H	0.500 Max	(12.7 Max)	1000 VDC	.010 µF	103	.804 µF	804
	T	0.320 Max	(8.13 Max)	2000 VDC	6800 pF	682	.240 µF	244
	S	0.475 ±0.03	(12.1 ±0.76)	3000 VDC	3300 pF	332	.073 µF	733
	LD	0.025 ±.002	(0.64 ±0.05)	4000 VDC	2200 pF	222	.028 µF	283
					5000 VDC	1000 pF	102	.013 µF
 H66	W	0.670 Max	(17.0 Max)	500 VDC	.150 µF	154	3.30 µF	335
	H	0.600 Max	(15.2 Max)	1000 VDC	.015 µF	153	1.20 µF	125
	T	0.320 Max	(8.13 Max)	2000 VDC	.010 µF	103	.440 µF	444
	S	0.575 ±0.03	(14.6 ±0.76)	3000 VDC	4700 pF	472	0.130 µF	134
	LD	0.025 ±.002	(0.64 ±0.05)	4000 VDC	3300 pF	332	.041 µF	413
					5000 VDC	2200 pF	222	.020 µF

See page 79 for additional dielectric specifications.

# HIGH VOLTAGE RADIAL LEADED CAPACITORS

CASE SIZE			RATED VOLTAGE	NP0 CAPACITANCE (MAX.)		X7R CAPACITANCE (MAX.)	
				VALUE	CODE	VALUE	CODE
	W H T S LD	IN. (MM)	500 VDC	.220 µF	224	5.70 µF	575
			1000 VDC	.022 µF	223	2.10 µF	215
			2000 VDC	.015 µF	153	.620 µF	624
			3000 VDC	6800 pF	682	.190 µF	194
			4000 VDC	4700 pF	472	.054 µF	543
			5000 VDC	3300 pF	332	.026 µF	263
	W H T S LD	IN. (MM)	500 VDC	.330 µF	334	7.30 µF	735
			1000 VDC	.100 µF	104	2.80 µF	285
			2000 VDC	.056 µF	563	.800 µF	804
			3000 VDC	.033 µF	333	.250 µF	254
			4000 VDC	.010 µF	103	.080 µF	803
			5000 VDC	6800 pF	682	.041 µF	413
	W H T S LD	IN. (MM)	500 VDC	.470 µF	474	12.0 µF	126
			1000 VDC	.150 µF	154	4.60 µF	465
			2000 VDC	.082 µF	823	1.20 µF	125
			3000 VDC	.047 µF	473	.390 µF	394
			4000 VDC	.015 µF	153	.130 µF	134
			5000 VDC	.010 µF	103	.068 µF	683

## T-SERIES 200°C

Johanson also offers two different series of high temperature radial leaded capacitors for 200°C. These components feature rugged premolded cases with Hi-Temp epoxy fill. The 200°C line is offered in voltage ratings of 25V to 4KV and maximum capacitance loss of -0.5% in NP0 and -45% in X7R. The line is offered in voltage ratings of 50V & 100V with maximum capacitance loss of -1.5% in NP0 and -55% in X7R. Please visit our website for complete component selection & specifications

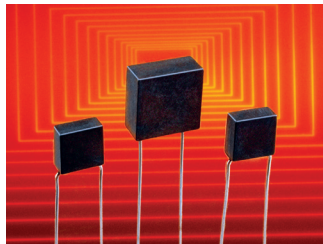

### APPLICATIONS

- Oil Well Logging (Downhole)
- Geophysical Probes
- Jet Engine Controls

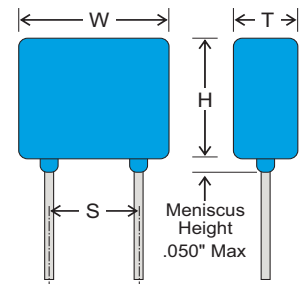

NOTE: Lead lengths are typically 1.25" for orders in bulk packaging. Leads are typically 1.00" for tape and reel packaging. Tape and reel packaging comes in 1000 piece reels.

## HOW TO ORDER HIGH VOLTAGE RADIALS

Part number written: 102H42W101KQ4T

102	H42	W	101	K	Q	4	T
VOLTAGE	SIZE	DIELECTRIC	CAPACITANCE	TOLERANCE	TERMINATION	MARKING	PACKING
501 = 500 V 102 = 1000 V 202 = 2000 V 302 = 3000 V 402 = 4000 V 502 = 5000 V	See Chart	N = NP0 W = X7R	1st two digits are significant; third digit denotes number of zeros. 102 = 1000 pF 103 = 0.01 µF 105 = 1.00 µF	J = ± 5% K = ± 10% M = ± 20% Z = +80% -20%	Q = Leaded & Encapsulated	4 = Standard 3 = Specified	T = Tape and Reel H = High Rel Testing per customer requirements S = Special Part



# RESISTOR WIREWOUND PRECISION

## RWP SERIES

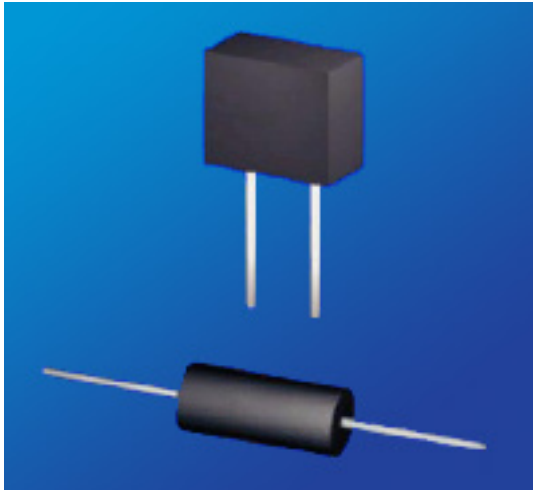

### KEY FEATURES

- Temperature Coefficients of  $\pm 2\text{ppm}/^\circ\text{C}$
- Temperature Range  $-55^\circ\text{C}$  to  $+145^\circ\text{C}$
- Resistance to 6 Mega-Ohms
- Resistance Tolerance starting at  $\pm 0.005\%$
- Long Term Stability / 100ppm/year
- High TCR Available - Platinum & Balco Wire
- Matched Resistance Sets to  $\pm 0.001$  and  $\pm 0.5 \text{ ppm}/^\circ\text{C}$
- 100% Acceptance Tested
- Options available: Wide TCR Range, High Stability and Fast Rise Time

### APPLICATIONS

- Smart Grid Metering
- Engine Sensors
- Power Inverters
- Temperature Sensors

### PRODUCT SUMMARY

PRODUCT SERIES (RWP)	RESISTANCE ( $\Omega$ )	POWER RATING (W)	TOLERANCE <sup>1</sup>	TEMPERATURE COEFFICIENT	TEMPERATURE RANGE <sup>1</sup>
Radial	Up to 1M	0.125 to 0.500	$\pm 0.005\%$ to 1%	<ul style="list-style-type: none"> <li>• <math>&gt;100\Omega : \pm 10\text{ppm}/^\circ\text{C}</math></li> <li>• <math>10\Omega \text{ to } 100\Omega : \pm 20\text{ppm}/^\circ\text{C}</math></li> <li>• <math>&lt;10\Omega : \pm 30\text{ppm}/^\circ\text{C}</math></li> </ul>	$-55^\circ\text{C}$ to $+145^\circ\text{C}$
Axial	Up to 6M	0.06 to 2.00			

### AVAILABLE OPTIONS (Consult Factory)

- **Wide TCR Range:** Low and High TCR configurations from  $-20\text{ppm}/^\circ\text{C}$  to  $+6000\text{ppm}/^\circ\text{C}$ . Down to  $1\text{ppm}/^\circ\text{C}$  available.
- **High Stability:** High stability version with maximum resistance change of  $\pm 20\text{ppm}/\text{year}$  under normal conditions.
- **Fast Rise Time:** Low reactance design for fast rise time and extended frequency response.
- **Special Testing Requirements**
- **Special Pulse Requirements**

<sup>1</sup> See Power Derating Curve

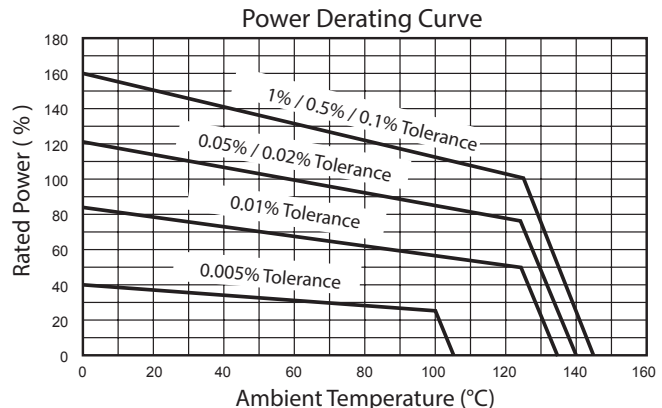

### HOW TO ORDER

RWP	A01	W	038K0	F	S
RESISTOR WIREWOUND PRECISION	PACKAGE CODE, WATTS, VOLTAGE	TEMPERATURE COEFFICIENT OF RESISTANCE (TCR)	RESISTANCE	TOLERANCE	PACKING
	Radial B01, 0.125W, 150Vmax B02, 0.250W, 150Vmax Axial A01, 0.06W, 75Vmax A02, 0.08W, 100Vmax See Table	W = $\pm 10\text{ppm}/^\circ\text{C}$ U = $\pm 20\text{ppm}/^\circ\text{C}$ S = $\pm 30\text{ppm}/^\circ\text{C}$ Z = special	0R038 = 0.038 $\Omega$ 003K8 = 3.8K $\Omega$ 038K0 = 38.0K $\Omega$ 380K0 = 380.0K $\Omega$ 003M8 = 3.8M $\Omega$ Letter denotes decimal place. R = decimal, "K" $10^3$ , "M" $10^6$ Remaining 4 digits are significant or placeholders	V = $\pm 0.005\%$ T = $\pm 0.01\%$ Q = $\pm 0.02\%$ A = $\pm 0.05\%$ B = $\pm 0.1\%$ F = $\pm 1.0\%$	S = Bulk T = Tape & Reel

For Tin/Lead coated leads, add "-Pb" to part number.

Standard Termination Finish: Matte Tin(Sn)

Example P/N: RWPA01W038K0FS is Resistor Wirewound Precision 0.06W, 75V,  $\pm 10\text{ppm}/^\circ\text{C}$  38.0K $\Omega$ ,  $\pm 1.0\%$ , bulk



## RWP SERIES

### RADIAL

Package Code		B01	B02	B03	B04
Max Resistance ( $\Omega$ )		500k	750k	500k	1M
Max Working Voltage (V)		150	150	150	150
Power Rating (W)		0.125	0.250	0.300	0.500
Dimensions Inches [mm]	Width $\pm 0.010''$ [ $\pm 0.25\text{mm}$ ]	0.140 [3.56]	0.150 [3.81]	0.102 [2.59]	0.160 [4.06]
	Height $\pm 0.025''$ [ $\pm 0.64\text{mm}$ ]	0.250 [6.35]	0.270 [6.86]	0.320 [8.13]	0.525 [13.34]
	Length $\pm 0.010''$ [ $\pm 0.25\text{mm}$ ]	0.270 [6.86]	0.540 [13.72]	0.300 [7.62]	0.585 [14.86]
	Lead Diameter <sup>1</sup> $\pm 0.002''$ [ $\pm 0.05\text{mm}$ ]	0.032 [0.81]	0.032 [0.81]	0.025 [0.64]	0.032 [0.81]
	Lead Spacing $\pm 0.015''$ [ $\pm 0.4\text{mm}$ ]	0.125 [3.18]	0.250 [6.35]	0.150 [3.81]	0.400 [10.16]

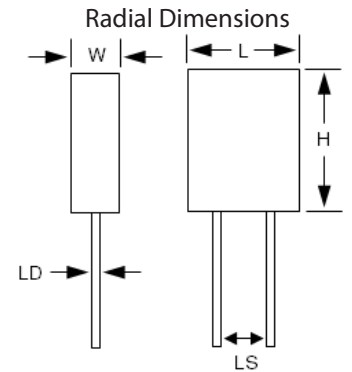

<sup>1</sup> Lead Length 1.00" [25.40mm] Min

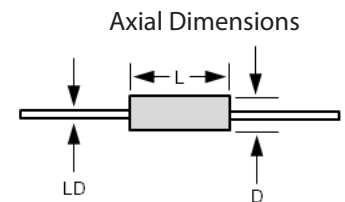

<sup>2</sup> Lead Length 1.50" [38.10mm] Min

Moisture Sensitivity Level: MSL-1

### AXIAL

Package Code		A01	A02	A03	A04	A05	A06	A07	A08	A09	A10	A11	A12
Max Resistance ( $\Omega$ )		75k	150k	150k	250k	250k	400k	500k	500k	750k	750k	1M	1M
Max Working Voltage (V)		75	100	100	100	100	150	150	100	200	200	200	200
Power Rating (W)		0.06	0.08	0.08	0.10	0.10	0.12	0.15	0.15	0.175	0.20	0.20	0.20
Dimensions Inches [mm]	Length $\pm 0.025''$ [ $\pm 0.64\text{mm}$ ]	0.210 [5.33]	0.260 [6.60]	0.260 [6.60]	0.375 [9.53]	0.312 [7.92]	0.250 [6.35]	0.295 [7.49]	0.250 [6.35]	0.375 [9.53]	0.450 [11.43]	0.375 [9.53]	0.375 [9.53]
	Diameter $\pm 0.005''$ [ $\pm 0.13\text{mm}$ ]	0.100 [2.54]	0.125 [3.18]	0.125 [3.18]	0.125 [3.18]	0.156 [3.96]	0.187 [4.75]	0.187 [4.75]	0.250 [6.35]	0.187 [4.75]	0.187 [4.75]	0.250 [6.35]	0.250 [6.35]
	Lead Diameter <sup>2</sup> $\pm 0.002''$ [ $\pm 0.05\text{mm}$ ]	0.020 [0.51]	0.020 [0.51]	0.025 [0.64]	0.020 [0.51]	0.020 [0.51]	0.025 [0.64]	0.025 [0.64]	0.025 [0.64]	0.025 [0.64]	0.025 [0.64]	0.025 [0.64]	0.032 [0.81]

Package Code		A13	A14	A15	A16	A17	A18	A19	A20	A21	A22	A23
Max Resistance ( $\Omega$ )		1M	1.2M	1.2M	2.5M	2.5M	3.8M	3.8M	6M	6M	6M	6M
Max Working Voltage (V)		250	300	300	400	400	300	400	600	800	900	1000
Power Rating (W)		0.25	0.25	0.25	0.33	0.33	0.40	0.50	0.75	1.00	1.50	2.00
Dimensions Inches [mm]	Length $\pm 0.025''$ [ $\pm 0.64\text{mm}$ ]	0.465 [11.81]	0.500 [12.70]	0.500 [12.70]	0.750 [19.05]	0.750 [19.05]	0.500 [12.70]	0.750 [19.05]	1.000 [25.40]	1.000 [25.40]	1.500 [38.10]	2.000 [50.80]
	Diameter $\pm 0.005''$ [ $\pm 0.13\text{mm}$ ]	0.210 [5.33]	0.250 [6.35]	0.250 [6.35]	0.250 [6.35]	0.250 [6.35]	0.375 [9.53]	0.375 [9.53]	0.375 [9.53]	0.500 [12.70]	0.500 [12.70]	0.500 [12.70]
	Lead Diameter <sup>2</sup> $\pm 0.002''$ [ $\pm 0.05\text{mm}$ ]	0.025 [0.64]	0.032 [0.81]	0.025 [0.64]	0.032 [0.81]	0.025 [0.64]	0.032 [0.81]	0.032 [0.81]	0.032 [0.81]	0.032 [0.81]	0.032 [0.81]	0.032 [0.81]

Moisture Sensitivity Level: MSL-1

This datasheet is subject to change without notice.



# RESISTOR WIREWOUND PRECISION SMT

## RWF SERIES

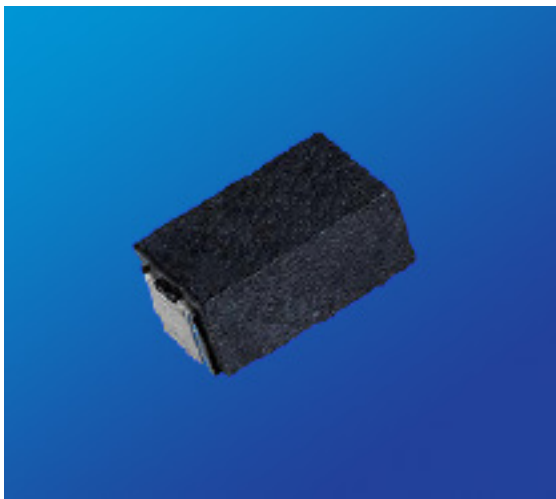

### KEY FEATURES

- Resistance from 0.005 to 50kOhms
- Precision, Flame Proof and Pulse Withstanding
- Tolerance to  $\pm 0.01\%$
- High Power to 4 Watts
- Flame Resistant UL 94V-0
- Superior Surge Handling Capability
- High Temperature Rating up to 275°
- Low Temperature Coefficient to  $\pm 20\text{ppm}/^\circ\text{C}$
- Non-Inductive Windings available

### APPLICATIONS

- Motor Control
- Braking Systems
- Power Supplies
- Pressure Transducers

### PRODUCT SUMMARY

PRODUCT SERIES (RWF)	RESISTANCE RANGE ( $\Omega$ ) <sup>1</sup>	POWER RATING (W) @ 70 °C	DIELECTRIC STRENGTH	TOLERANCE	TEMPERATURE COEFFICIENT	TEMPERATURE RANGE	INSULATION RESISTANCE
C1	0.01 to 400	0.5	1000 VAC	$\pm 0.01\%$ to $\pm 5\%$	<ul style="list-style-type: none"> <li>♦ <math>&gt;10\Omega</math> : <math>\pm 20\text{ppm}/^\circ\text{C}</math></li> <li>♦ <math>1\Omega</math> to <math>10\Omega</math> : <math>\pm 50\text{ppm}/^\circ\text{C}</math></li> <li>♦ <math>&lt;1\Omega</math> : Call Factory</li> </ul>	- 55°C to + 275°C	>1000 MOhms / Dry
C2	0.005 to 3k	1					
C3	0.01 to 15k	2					
C4	0.01 to 25k	3					
C5	0.01 to 50k	4					
D1	0.005 to 0.05	1	500 VAC	$\pm 0.1\%$ to $\pm 5\%$	$\pm 200\text{ppm}/^\circ\text{C}$ Call Factory For Lower		
D2	0.005 to 0.07	2					

<sup>1</sup> For non-inductive windings, divide max resistance by 2

$$\text{Maximum Working Voltage} = \sqrt{\text{Power} \times \text{Resistance}}$$

### AVAILABLE OPTIONS (Consult Factory)

- Special Testing Requirements
- Special Pulse Requirements

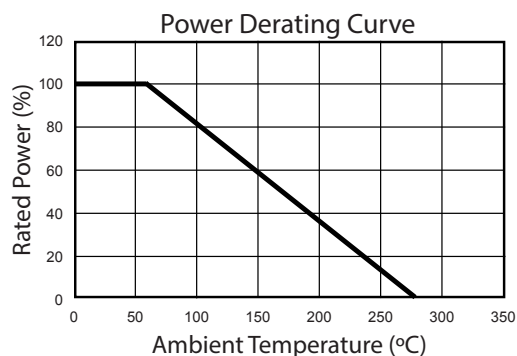

### HOW TO ORDER

RWF	N	C4	U	380R0	B	E
RESISTOR WIREWOUND SMT	WINDINGS	PACKAGE CODE, WATTS, RESISTANCE	TEMPERATURE COEFFICIENT OF RESISTANCE (TCR)	RESISTANCE	TOLERANCE	PACKING
	S = Standard N = Non-Inductive	C1, 0.5W, [0.01 to 400] $\Omega$ C2, 1.0W, [0.005 to 3k] $\Omega$ C3, 2.0W, [0.01 to 15k] $\Omega$ C4, 3.0W, [0.01 to 25k] $\Omega$ C5, 4.0W, [0.01 to 50k] $\Omega$  D1, 1.0W, [0.005 to 0.05] $\Omega$ D2, 2.0W, [0.005 to 0.07] $\Omega$	U = $\pm 20\text{ppm}/^\circ\text{C}$ Q = $\pm 50\text{PPM}/^\circ\text{C}$ L = $\pm 200\text{ppm}/^\circ\text{C}$ Z = special	0R038 = 0.038 $\Omega$ 003K8 = 3.8K $\Omega$ 038K0 = 38.0K $\Omega$ 380K0 = 380.0K $\Omega$ 003M8 = 3.8M $\Omega$ Letter denotes decimal place. R = decimal, "K" $10^3$ , "M" $10^6$ Remaining 4 digits are significant placeholders	T = $\pm 0.01\%$ Q = $\pm 0.02\%$ A = $\pm 0.05\%$ B = $\pm 0.1\%$ F = $\pm 1.0\%$ J = $\pm 5.0\%$	E = Embossed Tape & Reel

For Tin/Lead coated leads, add "- Pb" to part number.

Standard Termination Finish: Electroless Tin

Example P/N: RWFNC4U380R0BE is Resistor Wirewound Precision SMT Non-Inductive, 3.0W,  $\pm 20\text{ppm}/^\circ\text{C}$ , 380 $\Omega$ ,  $\pm 0.1\%$ , embossed tape & reel





## RWF SERIES

### MECHANICAL CHARACTERISTICS

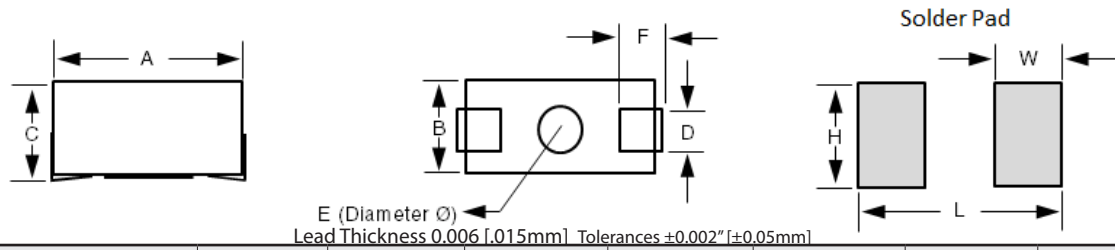

Package Code		C1	C2	C3	C4	C5	D1	D2
Dimensions Inches [mm]	A (Tolerances) ±0.015" [±0.4mm]	0.190 [4.83]	0.260 [6.60]	0.450 [11.43]	0.625 [15.83]	0.820 [20.83]	0.260 [6.60]	0.450 [11.43]
	B (Tolerances) ±0.015" [±0.4mm]	0.130 [3.30]	0.155 [3.94]	0.250 [6.35]	0.270 [6.86]	0.295 [7.49]	0.155 [3.94]	0.250 [6.35]
	C (Tolerances) ±0.015" [±0.4mm]	0.110 [2.79]	0.125 [3.18]	0.180 [4.57]	0.250 [6.35]	0.305 [7.75]	0.100 [2.54]	0.100 [2.54]
	D (Tolerances) ±0.015" [±0.4mm]	0.060 [1.52]	0.070 [1.78]	0.120 [3.05]	0.120 [3.05]	0.150 [3.81]	0.070 [1.78]	0.120 [3.05]
	F (Tolerances) ±0.015" [±0.4mm]	0.040 [1.02]	0.070 [1.78]	0.100 [2.54]	0.135 [3.43]	0.190 [4.83]	0.070 [1.78]	0.100 [2.54]
Stand-Off Inches [mm]	E (Tolerances) ±0.015" [±0.4mm]	0.100 [2.54]	0.120 [3.05]	0.190 [4.83]	0.150 [3.81]	0.245 [6.22]	0.120 [3.05]	0.190 [4.83]
	Height (Tolerances) ±0.005" [±0.13mm]	0.005 [0.13]	0.005 [0.13]	0.005 [0.13]	0.005 [0.13]	0.005 [0.13]	0.005 [0.13]	0.005 [0.13]
Solder Pad Inches [mm]	Width (Tolerances) ±0.015" [±0.4mm]	0.062 [1.57]	0.096 [2.44]	0.150 [3.81]	0.200 [5.08]	0.220 [5.59]	0.096 [2.44]	0.150 [3.81]
	Height (Tolerances) ±0.015" [±0.4mm]	0.100 [2.54]	0.150 [3.81]	0.200 [5.08]	0.220 [5.59]	0.250 [6.35]	0.150 [3.81]	0.200 [5.08]
	Length (Tolerances) ±0.015" [±0.4mm]	0.250 [6.35]	0.337 [8.56]	0.540 [13.72]	0.700 [17.78]	0.900 [22.86]	0.337 [8.56]	0.540 [13.72]

### ENVIRONMENTAL PERFORMANCE

Environmental Performance (MIL-STD 202)	ΔR Maximum
Load Life	±1% + 0.05 Ω
Moisture Resistance	
Dielectric	±0.5% + 0.05 Ω
Storage	
Shock	±0.5% + 0.05 Ω
Thermal Shock	
5X Overload (5s)	
Resistance to Heat Solder (260C, 10s)	

### PACKAGING INFORMATION

Package Code	C1	C2	C3	C4	C5	D1	D2
Reel/Tape Width [mm]	12	16	24	24	32	16	24
Small	650	600	250	125	180	600	250
Large	3000	2000	1000	500	500	2000	1000

#### Humidity Packaging Notes:

Moisture Barrier Bags (MBB) are used to package surface mount components. These bags include a desiccant and a Humidity Indicator Card to monitor humidity levels. All bags are marked with Moisture-Sensitive Identification Labels.

A Moisture Sensitivity Level (MSL) rating of 2 (1-year floor life) applies to the Johanson RWF Series.

This datasheet is subject to change without notice.



# RESISTOR WIREWOUND HIGH POWER RATING

## RWH SERIES

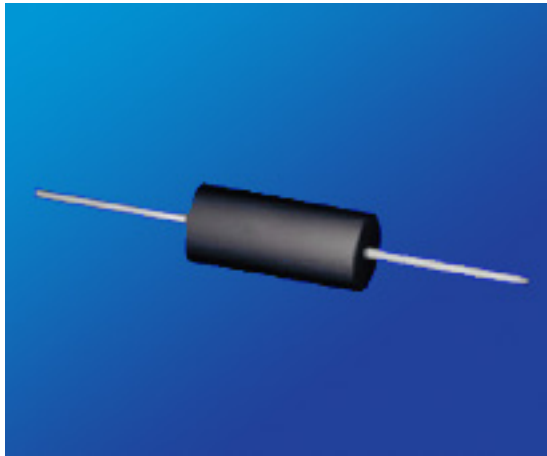

### KEY FEATURES

- Excellent Pulse Handling
- Resistance Tolerances to  $\pm 0.01\%$
- Resistance from 0.02 to 260kOhms
- MIL-R-26 / MIL-R-39007 Power Ratings
- Low TCR:  $\pm 20\text{ppm}/^\circ\text{C}$  Standard
- Non-Inductive Windings available

### APPLICATIONS

- HDVC Systems
- Braking Systems
- Power Supplies
- Fluid Heater

### PRODUCT SUMMARY

PRODUCT SERIES (RWH)	POWER RATING (W)	DIELECTRIC STRENGTH	TOLERANCE	TEMPERATURE COEFFICIENT	TEMPERATURE RANGE
Miniature Axial	1 to 15	500 VAC: E01, E02, E03, E04, E05, E06	$\pm 0.01\%$ to $\pm 10\%$ (1% Standard)	<ul style="list-style-type: none"> <li>• <math>&gt;10\Omega</math> : <math>\pm 20\text{ppm}/^\circ\text{C}</math></li> <li>• <math>1\Omega</math> to <math>10\Omega</math> : <math>\pm 50\text{ppm}/^\circ\text{C}</math></li> <li>• <math>&lt;1\Omega</math> : Call Factory</li> </ul>	-55°C to + 250°C
Axial	0.1 to 15	500 VAC: F01, F02, F03, F04, F05, F06, F07			1000 VAC: All Others

### HOW TO ORDER

RWH	S	E02	T	U	003K8	F	S
RESISTOR WIREWOUND HIGH POWER	WINDINGS	PACKAGE CODE, WATTS, RESISTANCE	OPERATING TEMPERATURE	TEMPERATURE COEFFICIENT OF RESISTANCE (TCR)	RESISTANCE	TOLERANCE	PACKING
	S = Standard N = Non-Inductive	Miniature Axial E01, 1.0W, 33Vmax E02, 1.0W, 33Vmax  Axial F01, 0.1W, 8.5Vmax F02, 0.4W, 20Vmax  See Table	T = -55°C to +250°C U = -55°C to +275°C V = -55°C to +350°C	U = $\pm 20\text{ppm}/^\circ\text{C}$ Q = $\pm 50\text{ppm}/^\circ\text{C}$ Z = Special	0R038 = 0.038 $\Omega$ 003K8 = 3.8K $\Omega$ 038K0 = 38.0K $\Omega$ 380K0 = 380.0K $\Omega$ 003M8 = 3.8M $\Omega$  Letter denotes decimal place. R = decimal, "K" $10^3$ , "M" $10^6$  Remaining 4 digits are significant or placeholders.	T = $\pm 0.01\%$ Q = $\pm 0.02\%$ A = $\pm 0.05\%$ B = $\pm 0.1\%$ F = $\pm 1.0\%$ J = $\pm 5.0\%$ K = $\pm 10.0\%$	S = Bulk T = Tape & Reel

For Tin/Lead coated leads, add "- Pb" to part number.

Standard Termination Finish: Matte Tin (Sn)

Example P/N: RWHSE02TU003K8FS is Resistor Wirewound High Power, Standard, 1.0W, 33V, -55°C to +250°C,  $\pm 20\text{ppm}/^\circ\text{C}$ , 3.8K $\Omega$ ,  $\pm 1.0\%$ , bulk

# RESISTOR WIREWOUND HIGH POWER RATING

## RWH SERIES

### MINIATURE AXIAL

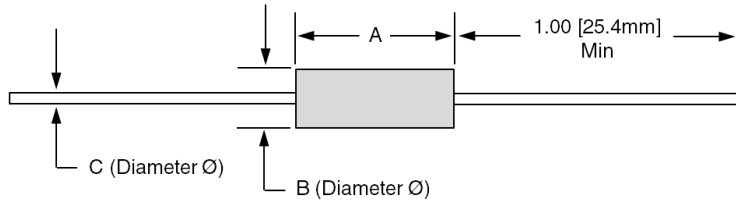

Package Code	E01	E02	E03	E04	E05	E06	E07	E08	E09	
Max Resistance ( $\Omega$ ) <sup>1</sup>	3.4k	3.4k	7.5k	7.5k	10k	10k	12.5k	25k	32k	
Max Working Voltage (V)	33	33	42	42	80	80	135	162	194	
Power Rating (W)	1	1	1.5	1.5	2	2	3	4	5	
Dimensions Inches [mm]	A $\pm 0.062$ " [ $\pm 1.57$ mm]	0.250 [6.35]	0.250 [6.35]	0.312 [7.92]	0.312 [7.92]	0.406 [10.31]	0.406 [10.31]	0.350 [8.89]	0.560 [14.22]	0.500 [12.70]
	B $\pm 0.031$ " [ $\pm 0.79$ mm]	0.085 [2.16]	0.085 [2.16]	0.078 [1.98]	0.078 [1.98]	0.094 [2.39]	0.094 [2.39]	0.156 [3.96]	0.187 [4.75]	0.218 [5.54]
	C <sup>2</sup> $\pm 0.002$ " [ $\pm 0.05$ mm]	0.020 [0.51]	0.025 [0.64]	0.020 [0.51]	0.025 [0.64]	0.025 [0.64]	0.020 [0.51]	0.032 [0.81]	0.032 [0.81]	0.040 [1.02]
MIL-R-26 / MIL-R-39007	RW-81 RWR-81	RW-81 RWR-81	RWR-82	RWR-82	RW-80 RWR-80	RW-80 RWR-80				

Package Code	E10	E11	E12	E13	
Max Resistance ( $\Omega$ ) <sup>1</sup>	50k	95k	150k	260k	
Max Working Voltage (V)	258	425	607	1050	
Power Rating (W)	6	7	10	15	
Dimensions Inches [mm]	A $\pm 0.062$ " [ $\pm 1.57$ mm]	0.625 [15.88]	0.875 [22.23]	1.220 [30.99]	1.780 [45.21]
	B $\pm 0.031$ " [ $\pm 0.79$ mm]	0.250 [6.35]	0.312 [7.92]	0.312 [7.92]	0.375 [9.53]
	C <sup>2</sup> $\pm 0.002$ " [ $\pm 0.05$ mm]	0.040 [1.02]	0.040 [1.02]	0.040 [1.02]	0.040 [1.02]
MIL-R-26 / MIL-R-39007		RW-84			

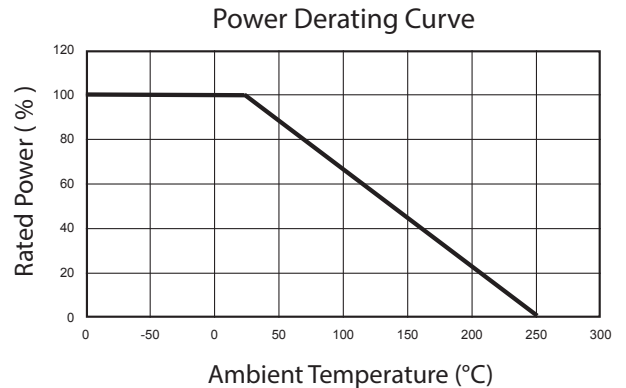

<sup>1</sup> For non-inductive windings / divide maximum resistance by 2

<sup>2</sup> Lead Diameter:

18 AWG = 0.040" / 20 AWG = 0.032" / 22 AWG = 0.025" / 24 AWG = 0.020"

# RESISTOR WIREWOUND HIGH POWER RATING

## RWH SERIES

**AXIAL**

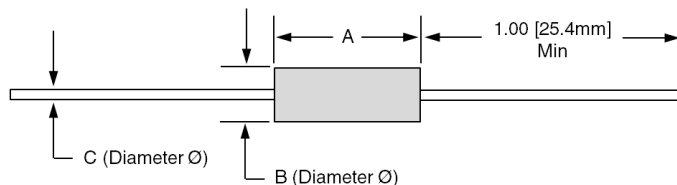

Package Code		F01	F02	F03	F04	F05	F06	F07	F08	F09	F10
Max Resistance ( $\Omega$ ) <sup>1</sup>		500	2.5k	2.5k	7.5k	7.5k	10k	10k	12.5k	22k	22k
Max Working Voltage (V)		8.5	20	20	29	29	52	52	60	130	140
Power Rating (W)	U	0.1	0.4	0.4	0.75	0.75	1.0	1.0	1.5	2.5	3.0
	V	0.25	0.5	0.5	0.9	0.9	1.5	1.5	2.0	3.0	3.75
Dimensions Inches [mm]	A $\pm 0.062''$ [ $\pm 1.57\text{mm}$ ]	0.150 [3.81]	0.250 [6.35]	0.250 [6.35]	0.330 [8.38]	0.330 [8.38]	0.406 [10.31]	0.406 [10.31]	0.350 [8.89]	0.500 [12.70]	0.560 [14.22]
	B $\pm 0.031''$ [ $\pm 0.79\text{mm}$ ]	0.078 [1.98]	0.094 [2.39]	0.094 [2.39]	0.094 [2.39]	0.094 [2.39]	0.094 [2.39]	0.094 [2.39]	0.156 [3.96]	0.187 [4.75]	0.187 [4.75]
	C <sup>2</sup> $\pm 0.002''$ [ $\pm 0.05\text{mm}$ ]	0.018 [0.45]	0.020 [0.51]	0.025 [0.64]	0.020 [0.51]	0.025 [0.64]	0.020 [0.51]	0.025 [0.64]	0.032 [0.81]	0.032 [0.81]	0.032 [0.81]
MIL-R-26 / MIL-R-39007							RW-70	RW-70		RW-69	RW-79

Package Code		F11	F12	F13	F14	F15	F16	F17	F18	F19	F20
Max Resistance ( $\Omega$ ) <sup>1</sup>		40k	40k	30k	45k	45k	91k	65k	95k	150k	100k
Max Working Voltage (V)		140	140	140	210	210	360	390	504	650	590
Power Rating (W)	U	3.0	3.0	3.0	4.0	4.0	5.0	5.0	5.0	7.0	7.0
	V	4.0	4.0	3.5	5.5	5.5	6.5	6.5	6.5	9.0	9.0
Dimensions Inches [mm]	A $\pm 0.062''$ [ $\pm 1.57\text{mm}$ ]	0.500 [12.70]	0.500 [12.70]	0.500 [12.70]	0.675 [17.15]	0.675 [17.15]	0.875 [22.23]	0.970 [24.64]	1.025 [26.04]	1.375 [34.93]	1.400 [35.56]
	B $\pm 0.031''$ [ $\pm 0.79\text{mm}$ ]	0.250 [6.35]	0.250 [6.35]	0.200 [5.08]	0.270 [6.68]	0.270 [6.68]	0.312 [7.92]	0.250 [6.35]	0.312 [7.92]	0.375 [9.52]	0.312 [7.92]
	C <sup>2</sup> $\pm 0.002''$ [ $\pm 0.05\text{mm}$ ]	0.040 [1.02]	0.032 [0.81]	0.032 [0.81]	0.040 [1.02]	0.032 [0.81]	0.040 [1.02]	0.032 [0.81]	0.040 [1.02]	0.040 [1.02]	0.032 [0.81]
MIL-R-26 / MIL-R-39007							RW-74		RW-67		

Package Code		F21	F22	F23
Max Resistance ( $\Omega$ ) <sup>1</sup>		154k	260k	320k
Max Working Voltage (V)		620	850	1500
Power Rating (W)	U	7.0	10	15
	V	9.0	13	-
Dimensions Inches [mm]	A $\pm 0.062''$ [ $\pm 1.57\text{mm}$ ]	1.200 [30.99]	1.780 [45.21]	1.810 [45.95]
	B $\pm 0.031''$ [ $\pm 0.79\text{mm}$ ]	0.312 [7.92]	0.375 [9.52]	0.510 [12.95]
	C <sup>2</sup> $\pm 0.002''$ [ $\pm 0.05\text{mm}$ ]	0.040 [1.02]	0.040 [1.02]	0.050 [1.27]
MIL-R-26 / MIL-R-39007			RW-78	

<sup>1</sup> For non-inductive windings / divide maximum resistance by 2

<sup>2</sup> Lead Diameter:

18 AWG = 0.040" / 20 AWG = 0.032" / 22 AWG = 0.025" /

24 AWG = 0.020" / 25 AWG = 0.018"

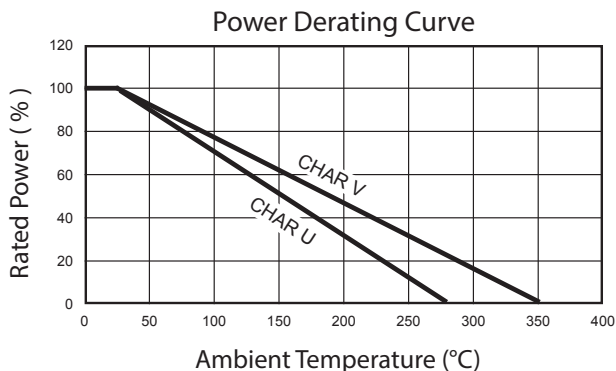

# RESISTOR WIREWOUND HIGH POWER RATING

## RWH SERIES

### ENVIRONMENTAL PERFORMANCE

Environmental Performance (MIL-STD 202)	$\Delta R$		
	Miniature Axial	Axial - Characteristic U	Axial - Characteristic V
Vibration	$\pm 0.1\% + 0.05 \Omega$	$\pm 0.1\% + 0.05 \Omega$	$\pm 0.2\% + 0.05 \Omega$
Load Life	To 1% Depending on Resistance Value and Size	$\pm 1\% + 0.05 \Omega$	$\pm 3\% + 0.05 \Omega$
Moisture Resistance	$\pm 0.2\% + 0.05 \Omega$	$\pm 0.2\% + 0.05 \Omega$	$\pm 2\% + 0.05 \Omega$
Dielectric	$\pm 0.2\% + 0.05 \Omega$	$\pm 0.2\% + 0.05 \Omega$	$\pm 0.2\% + 0.05 \Omega$
Storage	$\pm 0.2\% + 0.05 \Omega$	$\pm 0.2\% + 0.05 \Omega$	$\pm 2\% + 0.05 \Omega$
Shock	$\pm 0.1\% + 0.05 \Omega$	$\pm 0.1\% + 0.05 \Omega$	$\pm 0.2\% + 0.05 \Omega$
Thermal Shock	$\pm 0.2\% + 0.05 \Omega$	$\pm 0.2\% + 0.05 \Omega$	$\pm 2\% + 0.05 \Omega$
5X Overload (5s)	$\pm 0.2\% + 0.05 \Omega$	$\pm 0.2\% + 0.05 \Omega$	$\pm 2\% + 0.05 \Omega$

#### CONSTRUCTION NOTES:

- ◆ Centerless ground ceramic core
- ◆ Tinned copper or copperweld leads
- ◆ All welded terminations
- ◆ High Temperature / trivalent / inorganic silicone coating

### PACKAGING INFORMATION

MINIATURE AXIAL: Bulk Only

AXIAL:

Package Code	F01	F02	F03	F04	F05	F06	F07	F08	F09	F10	F11	F12	F13	
Bulk	Bulk Only. No T&R	1000	1000	1000	1000	1000	1000	1000	1000	1000	1000	1000	1000	
10" Reel		2000	2000	2000	2000	2000	2000	2000	500	500	500	500	500	
12" Reel		3000	3000	3000	3000	3000	3000	3000	3000	1500	1500	1000	1000	1000
14" Reel		5000	5000	5000	5000	5000	5000	5000	5000	3000	3000	1500	1500	1500

Package Code	F14	F15	F16	F17	F18	F19	F20	F21	F22
Bulk	1000	1000	1000	1000	1000	1000	1000	1000	1000
10" Reel	N/A	N/A	N/A	500	N/A	N/A	N/A	N/A	N/A
12" Reel	500	500	500	1000	500	500	500	500	500
14" Reel	1000	1000	1000	1500	1000	750	750	750	750

Moisture Sensitivity Level: MSL-1

### AVAILABLE OPTIONS (Consult Factory)

- Special Testing Requirements
- Special Pulse Requirements

This datasheet is subject to change without notice.



# RESISTOR WIREWOUND CHASSIS MOUNT

## RWC SERIES



### KEY FEATURES

- Resistances from 0.005 to 250kOhms
- Tolerance to  $\pm 0.01\%$
- High Temperature:  $-55^{\circ}\text{C}$  to  $+275^{\circ}\text{C}$
- Low TCR:  $\pm 20\text{ppm}/^{\circ}\text{C}$
- Power Rating 5 to 300 Watts
- Excellent Pulse Handling
- Non-Inductive windings available
- Four Terminal Versions Available (Call Factory)

### APPLICATIONS

- Motor Control
- Braking Systems
- Welding
- X-Ray

### PRODUCT SUMMARY

PRODUCT SERIES (RWC)	RESISTANCE RANGE ( $\Omega$ ) <sup>1</sup>	POWER RATING (W @ 25°C)			DIELECTRIC STRENGTH	TEMPERATURE COEFFICIENT	TEMPERATURE RANGE
		FREE AIR	COMMERCIAL	MIL			
G1	0.01 to 22K	4.5	7.5 <sup>a</sup>	5 <sup>a</sup>	1500 VAC	<ul style="list-style-type: none"> <li>◆ <math>&gt;10\Omega</math>: <math>\pm 20\text{ppm}/^{\circ}\text{C}</math></li> <li>◆ <math>1\Omega</math> to <math>10\Omega</math>: <math>\pm 50\text{ppm}/^{\circ}\text{C}</math></li> <li>◆ <math>&lt;1\Omega</math>: Call Factory</li> </ul>	- 55°C to + 275°C
G2	0.01 to 47K	7.5	12.5 <sup>a</sup>	10 <sup>a</sup>	1500 VAC		
G3	0.01 to 90K	12	25 <sup>b</sup>	20 <sup>b</sup>	2500 VAC		
G4	0.01 to 250K	20	50 <sup>c</sup>	30 <sup>c</sup>	3500 VAC		

TOLERANCE:  $\pm 0.01$  to  $\pm 10\%$  (1% Standard)

<sup>1</sup> For non-inductive windings, divide maximum resistance by 2

<sup>a</sup> Heatsink required: 0.040 [1.0] Aluminum Plate, 129 in<sup>2</sup> [832 cm<sup>2</sup>] or equiv.

<sup>b</sup> Heatsink required: 0.040 [1.0] Aluminum Plate, 167 in<sup>2</sup> [1077 cm<sup>2</sup>] or equiv.

<sup>c</sup> Heatsink required: 0.059 [1.5] Aluminum Plate, 291 in<sup>2</sup> [1877 cm<sup>2</sup>] or equiv.

<sup>d</sup> Heatsink required: 0.125 [3.2] Aluminum Plate, 294in<sup>2</sup> [1896cm<sup>2</sup>] or equiv.

<sup>e</sup> Heatsink required: 0.125 [3.2] Aluminum Plate, 895 in<sup>2</sup> [5780 cm<sup>2</sup>] or equiv.

### AVAILABLE OPTIONS (Consult Factory)

- Special Testing Requirements
- Special Pulse Requirements

### HOW TO ORDER

RWC	N	G1	U	003K8	F	S
RESISTOR WIRE-WOUND CHASSIS MOUNT	WINDINGS	PACKAGE CODE, WATTS (COMMERCIAL), RESISTANCE	TEMPERATURE COEFFICIENT OF RESISTANCE (TCR)	RESISTANCE	TOLERANCE	PACKING
	S = Standard N = Non-Inductive	G1, 7.5W, [0.01 to 22k] $\Omega$ G2, 12.5W, [0.01 to 47k] $\Omega$ G3, 25.0W, [0.01 to 90k] $\Omega$ G4, 50.0W, [0.01 to 250k] $\Omega$	U = $\pm 20\text{ppm}/^{\circ}\text{C}$ Q = $\pm 50\text{ppm}/^{\circ}\text{C}$ Z = Special	038R0 = 38 $\Omega$ 003K8 = 3.8K $\Omega$ 038K0 = 38.0K $\Omega$ 380K0 = 380.0K $\Omega$ 003M8 = 3.8M $\Omega$ Letter denotes decimal place. R = decimal, "K" 10 <sup>3</sup> , "M" 10 <sup>6</sup> Remaining 4 digits are significant or placeholders.	T = $\pm 0.01\%$ Q = $\pm 0.02\%$ A = $\pm 0.05\%$ B = $\pm 0.1\%$ F = $\pm 1.0\%$ J = $\pm 5.0\%$ K = $\pm 10.0\%$	S = Bulk

For Tin/Lead coated leads, add "- Pb" to part number.  
Standard Termination Finish: Matte Tin (Sn)

Example P/N: RWCNG1U003K8FS is Resistor Wirewound Chassis Mount, Non-Inductive, 7.5W,  $\pm 20\text{ppm}/^{\circ}\text{C}$ , 3.8K $\Omega$ ,  $\pm 1.0\%$ , bulk

# RESISTOR WIREWOUND CHASSIS MOUNT

**RWC SERIES**



## MECHANICAL CHARACTERISTICS

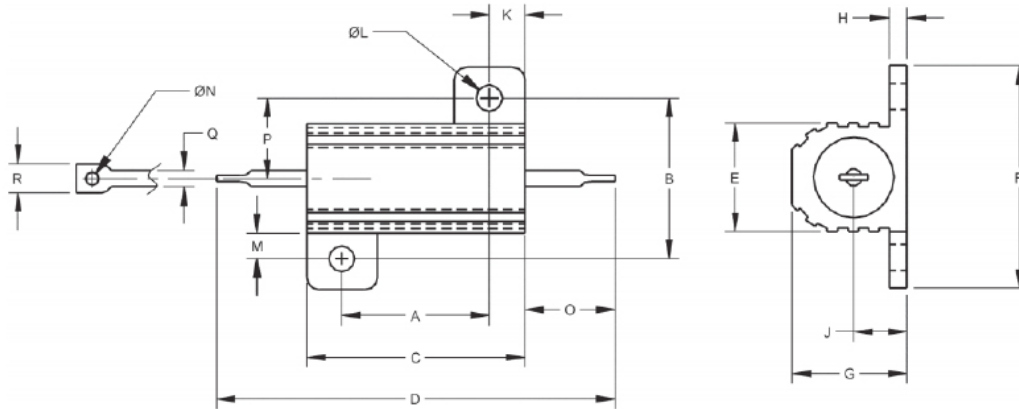

Package Code	G1	G2	G3	G4
A (Tolerances) ±0.005 [±0.13 mm]	0.444 [11.28]	0.562 [14.27]	0.719 [18.26]	1.563 [39.70]
B (Tolerances) ±0.005 [±0.13 mm]	0.490 [12.45]	0.625 [15.88]	0.781 [19.84]	0.844 [21.44]
C (Tolerances) ±0.031 [±0.79 mm]	0.600 [15.24]	0.750 [19.05]	1.062 [26.97]	1.968 [49.99]
D (Tolerances) ±0.062 [±1.57 mm]	1.125 [28.58]	1.320 [33.53]	1.870 [47.50]	2.760 [70.10]
E (Tolerances) ±0.015 [±0.38 mm]	0.334 [8.48]	0.430 [10.92]	0.530 [13.46]	0.615 [15.62]
F (Tolerances) ±0.015 [±0.38 mm]	0.646 [16.41]	0.800 [20.32]	1.080 [27.43]	1.140 [28.96]
G (Tolerances) ±0.015 [±0.38 mm]	0.320 [8.13]	0.400 [10.16]	0.560 [14.22]	0.615 [15.62]
H (Tolerances) ±0.010 [±0.25 mm]	0.065 [1.65]	0.075 [1.91]	0.085 [2.16]	0.085 [2.16]
J (Tolerances) ±0.010 [±0.25 mm]	0.140 [3.56]	0.190 [4.83]	0.260 [6.60]	0.300 [7.62]
K (Tolerances) ±0.010 [±0.25 mm]	0.078 [1.98]	0.093 [2.36]	0.172 [4.37]	0.196 [4.98]
L (Tolerances) ±0.005 [±0.13 mm]	0.093 [2.36]	0.093 [2.36]	0.125 [3.18]	0.125 [3.18]
M (Tolerances) ±0.015 [±0.38 mm]	0.078 [1.98]	0.102 [2.60]	0.125 [3.18]	0.125 [3.18]
N (Tolerances) ±0.006 [±0.15 mm]	0.050 [1.27]	0.080 [2.03]	0.080 [2.03]	0.080 [2.03]
O (Tolerances) ±0.062 [±1.57 mm]	0.266 [6.76]	0.312 [7.93]	0.438 [11.13]	0.438 [11.13]
P (Tolerances) ±0.031 [±0.79 mm]	0.245 [6.22]	0.312 [7.92]	0.391 [9.93]	0.422 [10.72]
Q (Tolerances) ±0.002 [±0.05 mm]	0.051 [1.30]	0.098 [2.49]	0.098 [2.49]	0.098 [2.49]
R (Tolerances) ±0.031 [±0.79 mm]	0.085 [2.16]	0.160 [4.06]	0.185 [4.70]	0.185 [4.70]
<b>MIL-R-39009 / MIL-R-18546</b>	RER-60 / RE-60	RER-65 / RE-65	RER-70 / RE-70	RER-75 / RE-75



# RESISTOR WIREWOUND CHASSIS MOUNT

## RWC SERIES



### ENVIRONMENTAL PERFORMANCE

Environmental Performance (MIL-STD 202)	$\Delta R$
Vibration	$\pm 0.1 \% + 0.05 \Omega$
Load Life	$\pm 1\% + 0.05 \Omega$
Moisture Resistance	$\pm 0.2 \% + 0.05 \Omega$
Dielectric	$\pm 0.2 \% + 0.05 \Omega$
Storage	$\pm 0.2 \% + 0.05 \Omega$
Shock	$\pm 0.1 \% + 0.05 \Omega$
Thermal Shock	$\pm 0.2 \% + 0.05 \Omega$
5X Overload (5s)	$\pm 0.2 \% + 0.05 \Omega$

#### CONSTRUCTION NOTES:

- ◆ Centerless ground ceramic core
- ◆ Tinned copper or copperweld leads
- ◆ All welded terminations
- ◆ High Temperature epoxy molding compound
- ◆ Anodized aluminum housing

Moisture Sensitivity Level: MSL-1

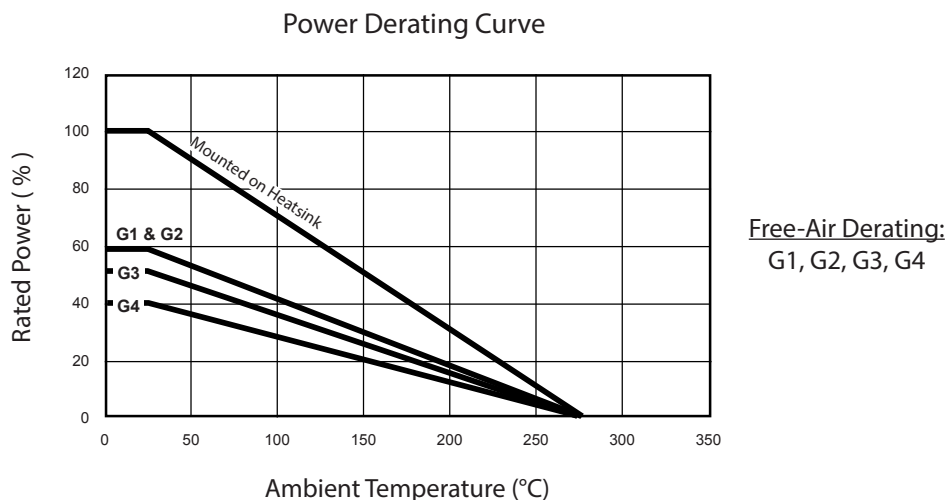

This datasheet is subject to change without notice.





# RESISTOR THIN FILM PRECISION RNP SERIES



## KEY FEATURES

- Resistances from 1 Ohm to 3M Ohms
- Resistance Tolerances to  $\pm 0.01\%$
- Power Rating 0.06 to 0.75 watts
- TCR's up to  $\pm 5\text{ppm}/^\circ\text{C}$
- Operating Temperature:  $- 55^\circ\text{C}$  to  $155^\circ\text{C}$
- Available in sizes 0402, 0603, 0805, 1206, 2010, 2512

## APPLICATIONS

- Motor Control
- Precision Scales
- Smart Grid Metering
- Temperature Sensors

## PRODUCT SUMMARY

PACKAGE SIZE	STANDARD POWER RATING (PAGE 42)		HIGH POWER RATING (PAGE 43)	
	RESISTANCE RANGE ( $\Omega$ )	POWER RATING (W) AT $70^\circ\text{C}$	RESISTANCE RANGE ( $\Omega$ )	POWER RATING (W) AT $70^\circ\text{C}$
0402	1 - 511K	0.0625	-	-
0603	1 - 1M	0.0625	4.7 - 1M	0.100
0805	1 - 2M	0.100	1 - 1M	0.125
1206	1 - 2.49M	0.125	4.7 - 1M	0.250
2010	1 - 3M	0.250	4.7 - 1M	0.333
2512	1 - 3M	0.500	1 - 2K	0.750

## AVAILABLE OPTIONS (Consult Factory)

- Special Testing Requirements

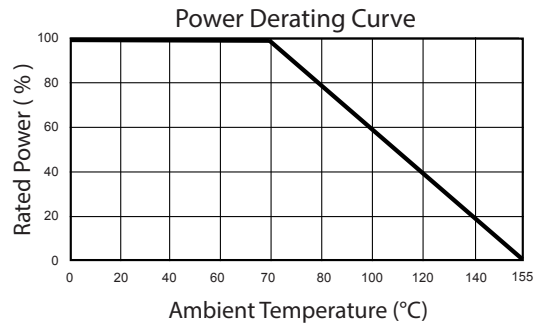

## HOW TO ORDER

RNP	14	H	W	003K8	B	T
RESISTOR THIN FILM PRECISION	PACKAGE CODE	POWER RATING	TEMPERATURE COEFFICIENT OF RESISTANCE (TCR)	RESISTANCE	TOLERANCE	PACKING
	07 = 0402 14 = 0603 15 = 0805 18 = 1206 19 = 2010 20 = 2512	S = Standard H = High Power	X = $\pm 5\text{ppm}/^\circ\text{C}$ W = $\pm 10\text{ppm}/^\circ\text{C}$ V = $\pm 15\text{ppm}/^\circ\text{C}$ T = $\pm 25\text{ppm}/^\circ\text{C}$ Q = $\pm 50\text{ppm}/^\circ\text{C}$	038R0 = $38\Omega$ 003K8 = $3.8\text{K}\Omega$ 038K0 = $38.0\text{K}\Omega$ 380K0 = $380.0\text{K}\Omega$ 003M8 = $3.8\text{M}\Omega$ Letter denotes decimal place. R = decimal, "K" $10^3$ , "M" $10^6$ Remaining 4 digits are significant or placeholders.	T = $\pm 0.01\%$ A = $\pm 0.05\%$ B = $\pm 0.1\%$ C = $\pm 0.25\%$ D = $\pm 0.5\%$ F = $\pm 1.0\%$	T = Paper Tape

Standard Termination Finish: Nickel Tin Alloy

Example P/N:

RNP14HW003K8BE is Resistor Thin Film Precision, 0603 size, high power rating,  $\pm 10\text{ppm}/^\circ\text{C}$ ,  $3.8\text{K}\Omega$ ,  $\pm 0.1\%$ , embossed tape & reel



# RESISTOR THIN FILM PRECISION



## RNP SERIES

### STANDARD POWER RATING SPECIFICATIONS

Standard Package Size		Size 0402 (RNP07S)					Size 0603 (RNP14S)					Size 0805 (RNP15S)						
Max Working Voltage (V) <sup>1</sup>		25V					50V					100V						
Max Overload Voltage (V) <sup>2</sup>		50V					100V					200V						
Power Rating (W) at 70°C		0.0625					0.0625					0.100						
TCR PPM/°C		±5	±10	±15	±25	±50	±5	±10	±15	±25	±50	±5	±10	±15	±25	±50		
Resistance Range (Ω)	±0.01% Tolerance	49.9Ω to 4.99KΩ	49.9Ω to 12KΩ		-		24.9Ω to 15KΩ	24.9Ω to 100KΩ		-		24.9Ω to 30KΩ	24.9Ω to 200KΩ		-			
	±0.05% Tolerance				49.9Ω to 12KΩ			4.7Ω to 332KΩ					4.7Ω to 1MΩ		4.7Ω to 1MΩ			
	±0.1% Tolerance		49.9Ω to 60KΩ      49.9Ω to 69.8KΩ		10Ω to 255KΩ			4.7Ω to 511KΩ		4.7Ω to 1MΩ			1Ω to 1MΩ      1Ω to 1MΩ		4.7Ω to 1MΩ		4.7Ω to 2MΩ	
	±0.25% Tolerance				4.7Ω to 511KΩ												1Ω to 2MΩ	
	±0.5% Tolerance																	
	±1% Tolerance																	

Standard Package Size		Size 1206 (RNP18S)					Size 2010 (RNP19S)					Size 2512 (RNP20S)						
Max Working Voltage (V) <sup>1</sup>		150V					150V					150V						
Max Overload Voltage (V) <sup>2</sup>		300V					300V					300V						
Power Rating (W) at 70°C		0.125					0.250					0.500						
TCR PPM/°C		±5	±10	±15	±25	±50	±5	±10	±15	±25	±50	±5	±10	±15	±25	±50		
Resistance Range (Ω)	±0.01% Tolerance	24.9Ω to 49.9KΩ	24.9Ω to 499KΩ		-		24.9Ω to 100KΩ	24.9Ω to 499KΩ		-		24.9Ω to 100KΩ	24.9Ω to 499KΩ		-			
	±0.05% Tolerance		4.7Ω to 1MΩ		4.7Ω to 1MΩ			4.7Ω to 1MΩ		4.7Ω to 1MΩ			4.7Ω to 1MΩ		4.7Ω to 1MΩ		4.7Ω to 1MΩ	
	±0.1% Tolerance				4.7Ω to 2.49MΩ			4.7Ω to 3MΩ		4.7Ω to 3MΩ			4.7Ω to 3MΩ					
	±0.25% Tolerance				1Ω to 2.49MΩ			1Ω to 3MΩ		1Ω to 3MΩ			1Ω to 3MΩ					
	±0.5% Tolerance																	
	±1% Tolerance																	

<sup>1</sup> Working Voltage =  $\sqrt{P \cdot R}$  or MAX Listed, whichever is lower.

<sup>2</sup> Overload Voltage =  $2.5 \cdot \sqrt{P \cdot R}$  or MAX Listed, whichever is lower.

# RESISTOR THIN FILM PRECISION RNP SERIES



## High Power Ratings Specifications

High Power Package Size	Size 0603 (RNP14H)					Size 0805 (RNP15H)					Size 1206 (RNP18H)				
Max Working Voltage (V) <sup>1</sup>	75V					150V					200V				
Max Overload Voltage (V) <sup>2</sup>	150V					300V					400V				
Power Rating (W) at 70°C	0.100					0.125					0.250				
TCR PPM/°C	±5	±10	±15	±25	±50	±5	±10	±15	±25	±50	±5	±10	±15	±25	±50
Resistance Range (Ω)	±0.01% Tolerance	24.9Ω to 15KΩ	24.9Ω to 100KΩ			24.9Ω to 30KΩ	24.9 to 200K				24.9Ω to 49.9KΩ	24.9Ω to 499KΩ			
	±0.05% Tolerance		4.7Ω to 332KΩ		4.7Ω to 511KΩ			4.7Ω to 1MΩ							
	±0.1% Tolerance		4.7Ω to 332KΩ		4.7Ω to 1MΩ		4.7Ω to 1MΩ		4.7Ω to 1MΩ						
	±0.25% Tolerance		4.7Ω to 332KΩ		4.7Ω to 1MΩ		4.7Ω to 1MΩ		4.7Ω to 1MΩ						
	±0.5% Tolerance		4.7Ω to 332KΩ		4.7Ω to 1MΩ		4.7Ω to 1MΩ		4.7Ω to 1MΩ						
	±1% Tolerance		4.7Ω to 332KΩ		4.7Ω to 1MΩ		4.7Ω to 1MΩ		4.7Ω to 1MΩ						

High Power Package Size	Size 2010 (RNP19H)					Size 2512 (RNP20H)			
Max Working Voltage (V) <sup>1</sup>	200V					200V			
Max Overload Voltage (V) <sup>2</sup>	400V					400V			
Power Rating (W) at 70°C	0.333					0.750			
TCR PPM/°C	±5	±10	±15	±25	±50	±10	±15	±25	±50
Resistance Range (Ω)	±0.01% Tolerance	24.9Ω to 49.9KΩ	24.9Ω to 499KΩ			24.9Ω to 2KΩ			
	±0.05% Tolerance		4.7Ω to 1MΩ			4.7Ω to 2KΩ			
	±0.1% Tolerance		4.7Ω to 1MΩ			4.7Ω to 2KΩ			
	±0.25% Tolerance		4.7Ω to 1MΩ			4.7Ω to 2KΩ			
	±0.5% Tolerance		4.7Ω to 1MΩ			4.7Ω to 2KΩ			
	±1% Tolerance		4.7Ω to 1MΩ			4.7Ω to 2KΩ			

<sup>1</sup> Working Voltage =  $\sqrt{P \cdot R}$  or MAX Listed, whichever is lower.

<sup>2</sup> Overload Voltage =  $2.5 \cdot \sqrt{P \cdot R}$  or MAX Listed, whichever is lower.



# RESISTOR THIN FILM PRECISION RNP SERIES



## MECHANICAL CHARACTERISTICS

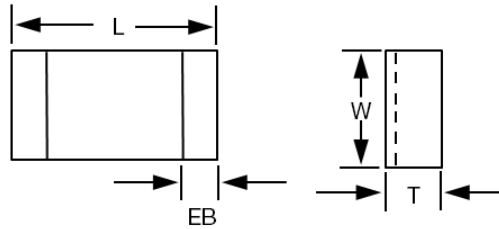

Package Size	Dimensions			
	L (Length) Inches [mm]	W (Width) Inches [mm]	T (Thickness) Inches [mm]	EB (End Band) Inches [mm]
0402	0.04 [1.02]	0.02 [0.51]	0.012 [0.30]	0.007 [0.18]
0603	0.06 [1.52]	0.03 [0.76]	0.018 [0.46]	0.012 [0.30]
0805	0.08 [2.03]	0.05 [1.27]	0.022 [0.56]	0.012 [0.30]
1206	0.12 [3.05]	0.06 [1.52]	0.022 [0.56]	0.016 [0.41]
2010	0.19 [4.83]	0.09 [2.29]	0.022 [0.56]	0.023 [0.58]
2512	0.25 [6.35]	0.12 [3.05]	0.022 [0.56]	0.023 [0.58]

## ENVIRONMENTAL CHARACTERISTICS

Test	Requirement		Conditions
	Tolerance <0.05%	Tolerance >0.05%	
Bending Strength	$\Delta R \pm 0.05\%$	$\Delta R \pm 0.2\%$	Bending amplitude 3mm for 10 seconds
Resistance to Soldering Heat	$\Delta R \pm 0.05\%$	$\Delta R \pm 0.2\%$	260 $\pm$ 5 $^{\circ}$ C for 10 seconds
Thermal Shock	$\Delta R \pm 0.05\%$	$\Delta R \pm 0.25\%$	-55 $^{\circ}$ C~150 $^{\circ}$ C, 100 cycles
Insulation Resistance	>1000 M $\Omega$		Apply 100VDC for 1 minute
TCR	As Spec.		+25/-55/+25/+125/+25 $^{\circ}$ C
Solderability	95% min coverage		245 $\pm$ 5 $^{\circ}$ C for 3 seconds
Damp Heat With Load	$\Delta R \pm 0.05\%$	$\Delta R \pm 0.3\%$	40 $\pm$ 2 $^{\circ}$ C, 90~95% R.H. Max. working voltage for 1000 hrs with 1.5 hrs "ON" and 0.5 hrs "OFF"
	$\Delta R \pm 0.5\%$ (For High Power Rating)		
Load Life	$\Delta R \pm 0.05\%$	$\Delta R \pm 0.2\%$	70 $\pm$ 2 $^{\circ}$ C, Max. working voltage for 1000 hrs with 1.5 hrs "ON" and 0.5 hrs "OFF"
	>7k $\Omega$ $\Delta R \pm 0.5\%$		
	$\Delta R \pm 0.5\%$ (For High Power Rating)		
Low Temperature Operation	$\Delta R \pm 0.05\%$	$\Delta R \pm 0.2\%$	1 hour, -65 $^{\circ}$ C, followed by 45 minutes of RCWV
	$\Delta R \pm 0.5\%$ (For High Power Rating)		
Short Time Overload	$\Delta R \pm 0.05\%$	$\Delta R \pm 0.2\%$	RCWV*2.5 or Max. overload voltage for 5 seconds
	$\Delta R \pm 0.2\%$ (For High Power Rating)		

Moisture Sensitivity Level: MSL-1

This datasheet is subject to change without notice.



# RESISTOR METAL ELEMENT CURRENT SENSE SMT

## RNC SERIES

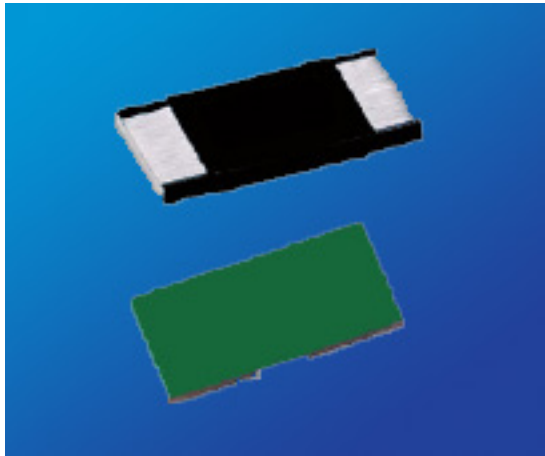

### KEY FEATURES

- Resistances from 0.5 mOhms to 15 mOhms
- Resistance Tolerances to  $\pm 1\%$
- Customized Resistance available
- Power Rating up to 3 Watts
- TCR's to  $\pm 50$  ppm/°C
- Available in sizes 1206 / 2010 / 2512

### APPLICATIONS

- Engine Sensors
- Surge Protection
- Data Recorders
- Temperature Sensors

### PRODUCT SUMMARY

PRODUCT SERIES (RNC)	PACKAGE SIZE	POWER RATING (W) at 80°C	RESISTANCES (mΩ)	TCR (ppm/°C)	TOLERANCES	TEMPERATURE RANGE
RNC18A	1206	1	0.5 - 10	$\pm 50$ $\pm 200$ (0.5 mΩ)	1% 3% 5%	-55°C to +170°C
RNC19B	2010	1.5	0.5 - 10	$\pm 50$ $\pm 100$ (0.5 mΩ)		
RNC20A <sup>1</sup>	2512	1	0.5, 0.75, 1, 1.5, 2, 11, 12, 13, 14, 15	$\pm 50$		
			6, 6.5, 7	$\pm 75$		
			4, 5, 10	$\pm 100$		
			2.5, 3	$\pm 150$		
RNC20C <sup>2</sup>	2512	2	0.5, 0.75, 1, 1.5, 2, 6.5, 7, 8, 9, 10	$\pm 50$		
			6, 6.5, 7	$\pm 75$		
			4, 5, 10	$\pm 100$		
			2.5, 3	$\pm 150$		
RNC20D <sup>3</sup>	2512	2.5	4, 4.5, 5, 6	$\pm 50$		
RNC20E <sup>3</sup>	2512	3	0.5, 0.75	$\pm 100$		
			1, 1.5, 2, 2.5, 3, 3.5	$\pm 50$		

Maximum Operating Voltage =  $\sqrt{\text{Power} \times \text{Resistance}}$

<sup>1</sup> 11, 12, 13, 14, 15 mΩ - coating is green

<sup>2</sup> 6.5, 7, 8, 9, 10 mΩ at 50ppm - coating is green

<sup>3</sup> All values contain green coating

### HOW TO ORDER

RNC	20	E	N	R00075	F	E
Resistor Metal Element Current Sense SMT	PACKAGE CODE	POWER RATING, WATTS	TEMPERATURE COEFFICIENT OF RESISTANCE (TCR)	RESISTANCE	TOLERANCE	PACKING
	18 = 1206 19 = 2010 20 = 2512	A = 1.0W B = 1.5W C = 2.0W D = 2.5W E = 3.0W	Q = $\pm 50$ ppm/°C P = $\pm 75$ ppm/°C N = $\pm 100$ ppm/°C M = $\pm 150$ ppm/°C L = $\pm 200$ ppm/°C	R00075 = 0.00075Ω (0.75mΩ) 0R0005 = 0.0005Ω (0.5mΩ) 00R001 = 0.001Ω (1mΩ) 0R0015 = 0.0015Ω (1.5mΩ) Letter denotes decimal place. R = decimal, "K" 10 <sup>3</sup> , "M" 10 <sup>6</sup> Remaining 5 digits are significant or placeholders.	F = $\pm 1.0\%$ H = $\pm 3.0\%$ J = $\pm 5.0\%$	E = Embossed Tape & Reel

Standard Termination Finish: Nickel Tin Alloy

Example P/N: RNC20ENR00075FT is Resistor Metal Element Current Sense SMT, size 2512, 3.0W,  $\pm 100$ ppm/°C, 0.00075Ω (0.75mΩ),  $\pm 1.0\%$ , embossed tape & reel



# RESISTOR METAL ELEMENT CURRENT SENSE SMT RNC SERIES



## ELECTRICAL & MECHANICAL CHARACTERISTICS

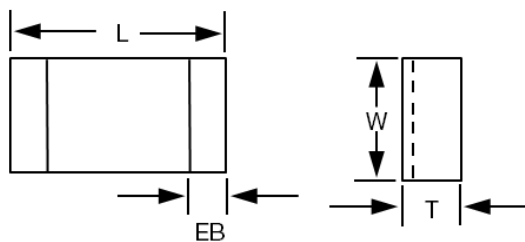

Package Code	Power Rating (W)	Resistance Value ( $\Omega$ )	L (Length) [mm]	W (Width) [mm]	T (Thickness) [mm]	EB (End Band) [mm]
RNC18 (Size 1206)	1	0.5	3.20 $\pm$ 0.25	1.60 $\pm$ 0.10	0.60 $\pm$ 0.20	1.35 $\pm$ 0.25
		0.75	3.20 $\pm$ 0.25	1.60 $\pm$ 0.10	0.60 $\pm$ 0.20	1.23 $\pm$ 0.25
		1, 4, 5, 6	3.20 $\pm$ 0.25	1.60 $\pm$ 0.10	0.60 $\pm$ 0.20	1.10 $\pm$ 0.25
		2, 3, 10	3.20 $\pm$ 0.25	1.60 $\pm$ 0.10	0.60 $\pm$ 0.20	0.60 $\pm$ 0.25
		7, 8, 9	3.20 $\pm$ 0.25	1.60 $\pm$ 0.10	0.60 $\pm$ 0.20	0.90 $\pm$ 0.25
RNC19 (Size 2010)	1.5	0.5	5.08 $\pm$ 0.25	2.54 $\pm$ 0.15	0.60 $\pm$ 0.20	2.17 $\pm$ 0.25
		0.75	5.08 $\pm$ 0.25	2.54 $\pm$ 0.15	0.60 $\pm$ 0.20	2.04 $\pm$ 0.25
		1	5.08 $\pm$ 0.25	2.54 $\pm$ 0.15	0.60 $\pm$ 0.20	1.84 $\pm$ 0.25
		2, 6, 7, 8	5.08 $\pm$ 0.25	2.54 $\pm$ 0.15	0.60 $\pm$ 0.20	1.54 $\pm$ 0.25
		3	5.08 $\pm$ 0.25	2.54 $\pm$ 0.15	0.60 $\pm$ 0.20	1.04 $\pm$ 0.25
		4, 5	5.08 $\pm$ 0.25	2.54 $\pm$ 0.15	0.60 $\pm$ 0.20	1.84 $\pm$ 0.25
RNC20 (Size 2512)	1	0.5	6.35 $\pm$ 0.254	3.18 $\pm$ 0.254	1.25 $\pm$ 0.20	1.30 $\pm$ 0.38
		0.75	6.35 $\pm$ 0.254	3.18 $\pm$ 0.254	0.75 $\pm$ 0.20	1.30 $\pm$ 0.38
		1	6.35 $\pm$ 0.254	3.18 $\pm$ 0.254	0.65 $\pm$ 0.20	1.30 $\pm$ 0.38
		1.5	6.35 $\pm$ 0.254	3.18 $\pm$ 0.254	0.45 $\pm$ 0.20	1.30 $\pm$ 0.38
		2	6.35 $\pm$ 0.254	3.18 $\pm$ 0.254	0.35 $\pm$ 0.20	1.30 $\pm$ 0.38
		2.5	6.35 $\pm$ 0.254	3.18 $\pm$ 0.254	0.65 $\pm$ 0.20	1.30 $\pm$ 0.38
		3	6.35 $\pm$ 0.254	3.18 $\pm$ 0.254	0.55 $\pm$ 0.20	1.30 $\pm$ 0.38
		4	6.35 $\pm$ 0.254	3.18 $\pm$ 0.254	0.45 $\pm$ 0.20	1.30 $\pm$ 0.38
		5	6.35 $\pm$ 0.254	3.18 $\pm$ 0.254	0.35 $\pm$ 0.20	1.30 $\pm$ 0.38
		6	6.35 $\pm$ 0.254	3.18 $\pm$ 0.254	0.32 $\pm$ 0.20	1.30 $\pm$ 0.38
		6.5	6.35 $\pm$ 0.254	3.18 $\pm$ 0.254	0.30 $\pm$ 0.20	1.30 $\pm$ 0.38
		7	6.35 $\pm$ 0.254	3.18 $\pm$ 0.254	0.27 $\pm$ 0.20	1.30 $\pm$ 0.38
10	6.35 $\pm$ 0.254	3.18 $\pm$ 0.254	0.25 $\pm$ 0.20	1.30 $\pm$ 0.38		
RNC20 w/Green Coating (Size 2512)	1 to 3	0.5	6.35 $\pm$ 0.25	3.00 $\pm$ 0.20	0.60 $\pm$ 0.20	2.68 $\pm$ 0.25
		0.75	6.35 $\pm$ 0.25	3.00 $\pm$ 0.20	0.60 $\pm$ 0.20	2.48 $\pm$ 0.25
		1, 5, 6	6.35 $\pm$ 0.25	3.00 $\pm$ 0.20	0.60 $\pm$ 0.20	1.93 $\pm$ 0.25
		1.5, 6.5, 7	6.35 $\pm$ 0.25	3.00 $\pm$ 0.20	0.60 $\pm$ 0.20	1.43 $\pm$ 0.25
		2, 3	6.35 $\pm$ 0.25	3.00 $\pm$ 0.20	0.60 $\pm$ 0.20	1.18 $\pm$ 0.25
		4, 4.5	6.35 $\pm$ 0.25	3.00 $\pm$ 0.20	0.60 $\pm$ 0.20	2.18 $\pm$ 0.25
		8 to 15	6.35 $\pm$ 0.25	3.00 $\pm$ 0.20	0.60 $\pm$ 0.20	1.18 $\pm$ 0.25

# RESISTOR METAL ELEMENT CURRENT SENSE SMT RNC SERIES

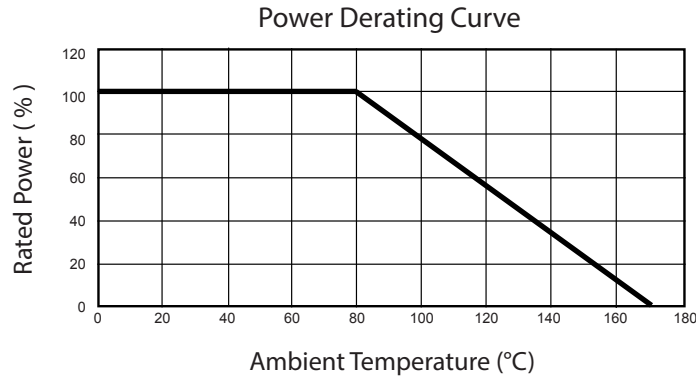

## SPECIFICATIONS

Test	Specification		Test Method
	Black Coating	Green Coating	
Solderability	95% min. coverage		245 ±5°C for 3 seconds
Temperature Coefficient of Resistance	As Spec.		+25/-55/+25/+125/+25°C
Dry Heat	± 1.0%	± 1.0%	at +170°C for 1000 hrs
Load Life	± 1.0%	± 1.0%	70 ±2°C, Max. working voltage for 1000 hrs with 1.5 hrs "ON" and 0.5 hrs "OFF"
Short Time Overload	± 0.5%	± 1.0%	5x rated power for 5 seconds
Resistance to Soldering Heat	± 0.5%	± 1.0%	260 ±5°C for 10 seconds
Thermal Shock	± 0.5%	± (0.5% + 0.05Ω)	-55°C ~ 150°C, 100 cycles

Note: Green coating cannot be used in solder bath

## PACKAGING INFORMATION

Package Code	RNC18 (Reel Size 1206)	RNC19 (Reel Size 2010)	RNC20 (Reel Size 2512)
Quantity	2000		
Type	Embossed Tape		

Moisture Sensitivity Level: MSL-1

## AVAILABLE OPTIONS (Consult Factory)

- Special Testing Requirements

This datasheet is subject to change without notice.



# RESISTOR HIGH POWER LOW INDUCTANCE

## RHX SERIES

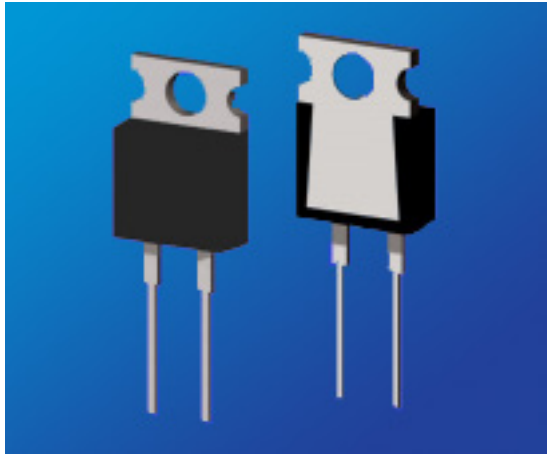

### KEY FEATURES

- Resistances from 51k Ohms
- High Stability Film Resistance Elements
- Rated Power of 35, 50 and 100 Watts
- TO-220 and TO-247 Housing
- Resistance tolerance of  $\pm 0.1\%$  or  $\pm 1\%$
- Low Inductance of  $< 10\text{nH}$  for RHXH1 and RHXH2,  $< 50\text{nH}$  for RHXH3

### APPLICATIONS

- Power Inverters
- Power Supplies
- Engine Sensors
- Temperature Sensors

### PRODUCT SUMMARY

PRODUCT SERIES (RHX)	RESISTANCE RANGE ( $\Omega$ ) <sup>3</sup>		POWER RATING (W)		THERMAL RESISTANCE	TOLERANCES
	MIN	MAX	HEATSINK <sup>1</sup>	FREE AIR <sup>2</sup>		
RHXH1	0.02	51K	35	1	3.3°C/W	$\pm 1\%$ ( $R \geq 0.1\Omega$ ) $\pm 5\%$
RHXH2	0.02	51K	50	1	2.3°C/W	$\pm 1\%$ ( $R \geq 0.1\Omega$ ) $\pm 5\%$
RHXH3	0.02	51K	100	3	1.3°C/W	$\pm 1\%$ ( $R \geq 0.10\Omega$ ) $\pm 5\%$

<sup>1</sup> Power Rating based on 25°C Flange Temperature

<sup>2</sup> Power Rating based on 25°C Ambient Temperature

<sup>3</sup> Contact Factory for Higher or Lower Values

### AVAILABLE OPTIONS (Consult Factory)

- Special Testing Requirements

#### TEMPERATURE COEFFICIENTS:

- $\pm 50\text{ppm}/^\circ\text{C}$  ( $R \geq 10\Omega$ )
- $\pm 100\text{ppm}/^\circ\text{C}$  ( $0.1\Omega \leq R < 10\Omega$ )
- $\pm 250\text{ppm}/^\circ\text{C}$  ( $R < 0.1\Omega$ )

### HOW TO ORDER

RHX	H2	Q	038K0	F	4
RESISTOR HIGH POWER LOW INDUCTANCE	PACKAGE CODE	TEMPERATURE COEFFICIENT OF RESISTANCE (TCR)	RESISTANCE	TOLERANCE	PACKING
	H1, 35W, TO-220 H2, 50W, TO-220 H3, 100W, TO-247	Q = $\pm 50\text{ppm}/^\circ\text{C}$ N = $\pm 100\text{ppm}/^\circ\text{C}$ K = $\pm 250\text{ppm}/^\circ\text{C}$	0R038 = 0.038 $\Omega$ 003K8 = 3.8K $\Omega$ 038K0 = 38.0K $\Omega$ 380K0 = 380.0K $\Omega$ 003M8 = 3.8M $\Omega$ Letter denotes decimal place. R = decimal, "K" $10^3$ , "M" $10^6$ Remaining 4 digits are significant or placeholders.	F = $\pm 1.0\%$ ( $R \geq 0.1\Omega$ ) J = $\pm 5.0\%$	4 = Tube

Tin/Lead coated leads, add "- Pb" on part number.

Standard Termination Finish: Matte Tin (Sn)

Example P/N: RHXH2Q038K0F4 is Resistor High Power Low Inductance, 50W TO-220,  $\pm 50\text{ppm}/^\circ\text{C}$ , 38.0K $\Omega$ ,  $\pm 1.0\%$ , tube



# RESISTOR HIGH POWER LOW INDUCTANCE RHX SERIES



## ENVIRONMENTAL CHARACTERISTICS

Electrical Characteristics	RHXH1 & RHXH2 Values	RHXH3 Value
Maximum Current	25A	-
Inductance	<10nH ( At the Standoff )	-
Insulation Resistance	>1000 Megohm	>1000 Megohm
Dielectric Strength	2000 VAC	2500 VAC
Temperature Range	-55°C to +155°C	-55°C to +155°C
Maximum Working Voltage	$\sqrt{Power \times Resistance}$ (500V MAX)	700 V or $\sqrt{Power \times Resistance}$ , whichever is less

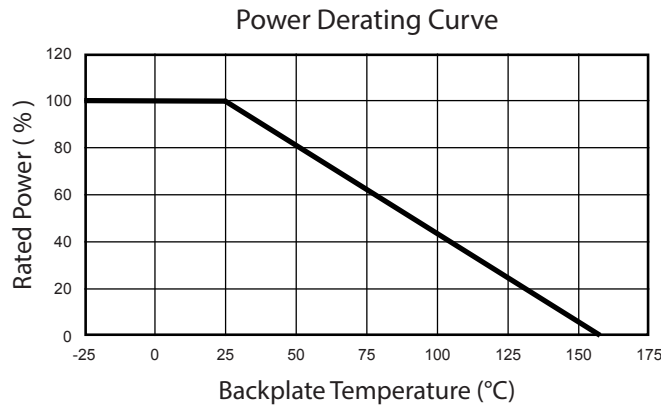

### RHXH1 & RHXH2 POWER RATING NOTES:

- ◆ H1 and H2 High Power Low Inductance Resistors must be attached to a suitable heatsink. Without a heatsink, the maximum power rating is 1W.
- ◆ The maximum internal resistor temperature is 155°C.
- ◆ Use the following formula to specify an appropriate heatsink:

### RHXH3 POWER RATING NOTES:

- ◆ H3 High Power Low Inductance Resistors must be attached to a suitable heatsink.
- ◆ The maximum internal resistor temperature is 155°C.
- ◆ Use the following formula to specify appropriate heatsink:

$$R_{\theta H} = \frac{T_{MAX} - (P * R_{\theta R}) - T_A}{P}$$

Where:  $R_{\theta H}$  = Thermal Resistance of Heatsink ( °C/W )  
 $R_{\theta R}$  = Thermal Resistance of Resistor ( °C/W )  
 $T_{MAX}$  = Maximum Temperature of Resistor ( °C )  
 $T_A$  = Ambient Temperature of Heatsink ( °C )  
 $P$  = Power Through Resistor ( W )



# RESISTOR HIGH POWER LOW INDUCTANCE RHX SERIES



## MECHANICAL CHARACTERISTICS

**RHXH1 & RHXH2**

**MOUNTING NOTES:**

- ♦ H1 and H2 High Power Low Inductance Resistors must be attached to a suitable heatsink.
- ♦ Use thermal grease to mount resistor to a clean, flat surface.
- ♦ Use a compression washer to provide 150 to 300 pounds ( 665 to 1330N ) of mounting force.
- ♦ Torque mounting screw to 8 in-lbs ( 0.9 N-m ).
- ♦ Mounting tab is isolated from both pins.

**RHXH3**

**MOUNTING NOTES:**

- ♦ H3 High Power Low Inductance Resistors must be attached to a suitable heatsink.
- ♦ Use thermal grease to mount resistor to a clean, flat surface.
- ♦ Use a compression washer to provide 150 to 300 pounds ( 665 to 1330N ) of mounting force.
- ♦ Torque mounting screw to 8 in-lbs ( 0.9 N-m ).
- ♦ Back plate is isolated from both pins.

## ENVIRONMENTAL CHARACTERISTICS

Environmental Performance	$\Delta R$			Test Conditions
	RHXH1	RHXH2	RHXH3	
Humidity Resistance	$\pm 1\% + 0.05\Omega$			40°C, 90-95% RH, DC 0.1W, 1000 hr
Load Life	$\pm 1\% + 0.05\Omega$			25°C, 90 min ON, 30 min OFF, 1000 hr
Temperature Cycle	$\pm 0.25\% + 0.05\Omega$			-55°C for 30 min, +155°C for 30 min, 1000 hr
Vibration	$\pm 0.25\% + 0.05\Omega$			IEC60068-2-6
Solder Heat	$\pm 0.1\% + 0.05\Omega$			+350°C, 3s

Moisture Sensitivity Level: MSL-1



# RESISTOR HIGH POWER LOW INDUCTANCE RHX SERIES



## PULSE ENERGY CAPABILITY

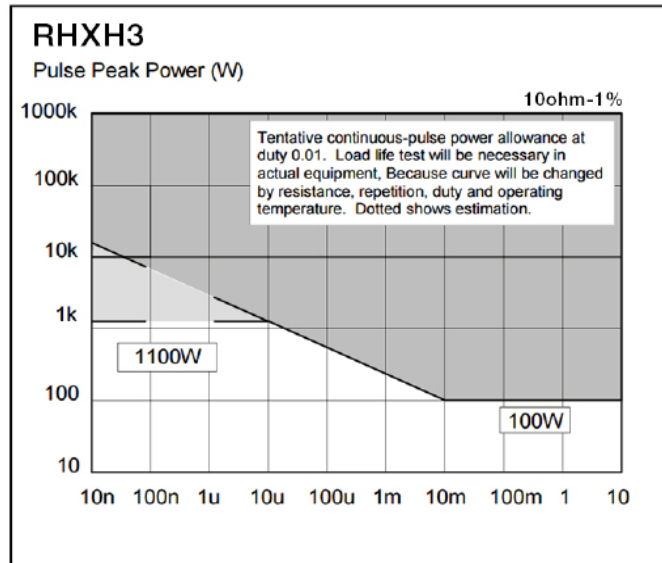
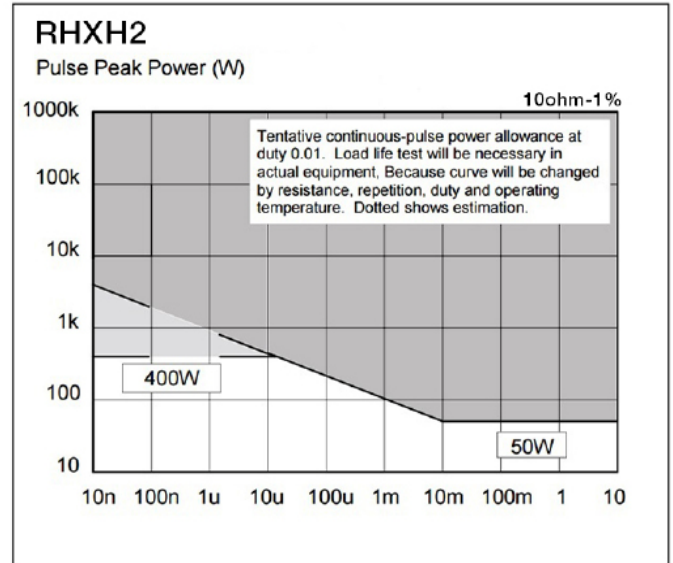
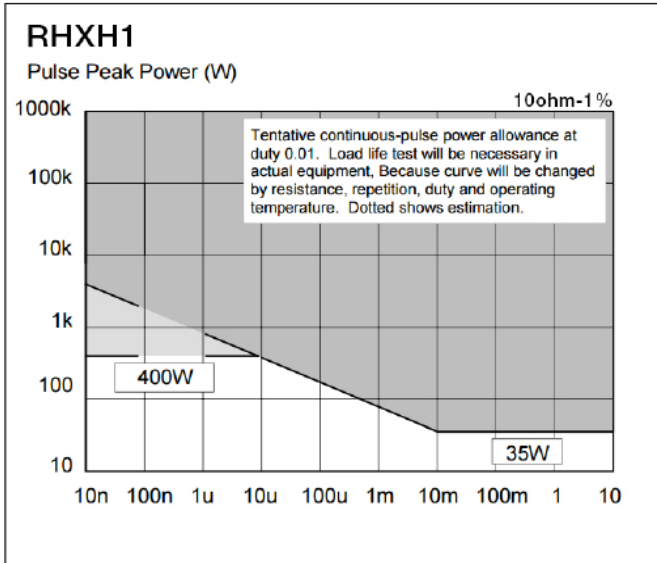

This datasheet is subject to change without notice.



# RESISTOR THICK FILM, HIGH TEMPERATURE

## RKS SERIES

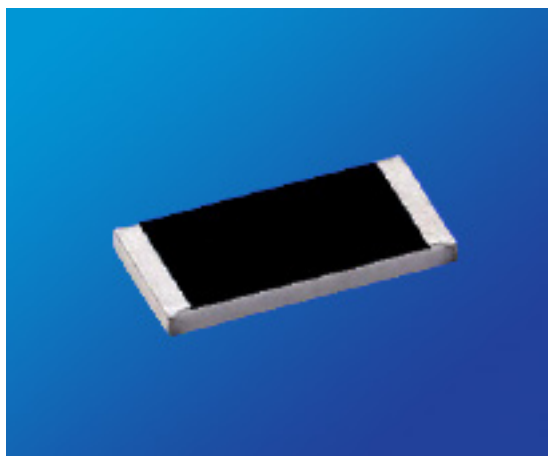

### KEY FEATURES

- Resistances from 10M to 1TOhms
- Resistance Tolerances to  $\pm 0.25\%$
- Power Rating 0.05 to 2 Watts
- Non-Magnetic
- TCR's to  $\pm 25\text{ppm}/^\circ\text{C}$
- Special High Temperature Version to  $300^\circ\text{C}$
- High Value Thick Film Resistance Element
- Available in sizes 0420, 0603, 0805, 1206, 1210, 2512, 4020

### APPLICATIONS

- Engine Sensors
- Surge Protection
- Data Recorders
- Temperature Sensors

### PRODUCT SUMMARY

PRODUCT SERIES (RKS)	SIZE	POWER RATING (W) <sup>1</sup>	WORKING VOLTAGE (VAC)		TEMPERATURE RANGE <sup>2</sup>
			TRIMMED	UNTRIMMED ( $\geq 5\%$ )	
RKS07	0402	0.050	30	60	<ul style="list-style-type: none"> <li>• <math>-55^\circ\text{C}</math> to <math>+155^\circ\text{C}</math> (Standard Version)</li> <li>• <math>-55^\circ\text{C}</math> to <math>+300^\circ\text{C}</math> (High Temperature Version TCR valid <math>+25^\circ\text{C}</math> to <math>+125^\circ\text{C}</math>)</li> </ul>
RKS14	0603	0.1	75	150	
RKS15	0805	0.125	100	200	
RKS18	1206	0.25	200	400	
RKS41	1210	0.35	300	600	
RKS20	2512	1.00	1500	2000	
RKS21	4020	2.00	4000	6000	

<sup>1</sup> Solder Pads must have sufficient heat conduction

<sup>2</sup> See Power Derating Curve

- TEMPERATURE COEFFICIENT:  $\pm 25\text{ppm}/^\circ\text{C}$  to  $\pm 3000\text{ppm}/^\circ\text{C}$
- TOLERANCE RANGE:  $\pm 0.25\%$  to  $\pm 30\%$

### AVAILABLE OPTIONS (Consult Factory)

- Special Testing Requirements

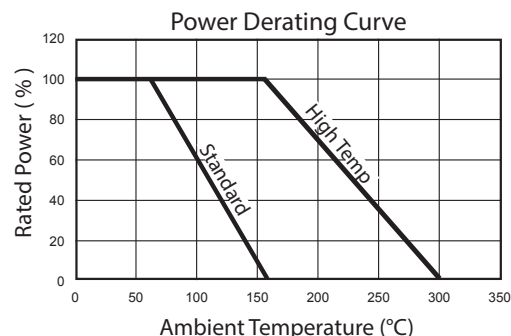

### HOW TO ORDER

RKS	21	W	N	038M0	K	E
RESISTOR THICK FILM	PACKAGE CODE	OPERATING TEMPERATURE	TEMPERATURE COEFFICIENT OF RESISTANCE (TCR)	RESISTANCE	TOLERANCE	PACKING
	07 = 0402 14 = 0603 15 = 0805 18 = 1206 41 = 1210 20 = 2512 21 = 4020	S = $-55^\circ\text{C}$ to $+155^\circ\text{C}$ W = $-55^\circ\text{C}$ to $+300^\circ\text{C}$	T = $\pm 25\text{ppm}/^\circ\text{C}$ Q = $\pm 50\text{ppm}/^\circ\text{C}$ N = $\pm 100\text{ppm}/^\circ\text{C}$ K = $\pm 250\text{ppm}/^\circ\text{C}$ J = $\pm 500\text{ppm}/^\circ\text{C}$ H = $\pm 1000\text{ppm}/^\circ\text{C}$ G = $\pm 2000\text{ppm}/^\circ\text{C}$ F = $\pm 3000\text{ppm}/^\circ\text{C}$	038M0 = $38.0\text{M}\Omega$ 380M0 = $380\text{M}\Omega$ 00368 = $3.86\Omega$ 03860 = $386\Omega$ 001T0 = $1.0\text{T}\Omega$ Letter denotes decimal place. "M" $10^6$ , "G" $10^9$ , "T" $10^{12}$ Remaining 4 digits are significant or placeholders.	C = $\pm 0.25\%$ D = $\pm 0.50\%$ F = $\pm 1.0\%$ G = $\pm 2.0\%$ J = $\pm 5.0\%$ K = $\pm 10.0\%$ M = $\pm 20.0\%$ N = $\pm 30.0\%$	E = Embossed Tape & Reel

Silver Termination Finish: Plat/Silver

Example P/N: RKS21WN038M0KE is Resistor Thick Film, size 4020,  $-55^\circ\text{C}$  to  $+300^\circ\text{C}$ ,  $\pm 100\text{ppm}/^\circ\text{C}$ ,  $38.0\text{M}\Omega$ ,  $\pm 10.0\%$ , embossed tape & reel

# RESISTOR THICK FILM, HIGH TEMPERATURE

## RKS SERIES

### ELECTRICAL CHARACTERISTICS

Package Size	Tolerances Available ( % ) Temperature Coefficients Available ( ± ppm/°C ) <sup>2</sup> Voltage Coefficients Available ( ppm / V ) <sup>2</sup>					
	Resistance Ranges ( W )					
	10M - 100M	>100M - 500M	>500M - 1G	>1G - 10G	>10G - 100G	>100G - 1T
0402	5 to 20% 50, 100 500ppm/V	5% to 20% 100, 250 1000ppm/V	5% to 20% 250, 500 1000ppm/V	10% to 30% 1000, 2000 2000ppm/V	10% to 30% 2000, 3000 5000ppm/V	Contact Factory
0603	1 to 20% 50, 100 500ppm/V	2% to 20% 100, 250 500ppm/V	5% to 20% 250, 500 1000ppm/V	5% to 30% 500, 1000 2000ppm/V	10% to 30% 2000, 3000 5000ppm/V	Contact Factory
0805	0.5 to 20% 50, 100 500ppm/V	2% to 20% 100, 250 500ppm/V	5% to 20% 250, 500 500ppm/V	5% to 20% 500, 1000 1000ppm/V	10% to 30% 1000, 2000 3000ppm/V	-
1206	0.5% to 20% 25, 50, 100 250ppm/V	2% to 20% 50, 100, 250 500ppm/V	5% to 20% 100, 250 500ppm/V	5% to 20% 500, 1000 500ppm/V	10% to 30% 1000, 2000 1000ppm/V	-
1210	0.5% to 20% 25, 50, 100 25ppm/V	2% to 20% 50, 100, 250 250ppm/V	5% to 20% 100, 250 250ppm/V	5% to 20% 250, 500 250ppm/V	5% to 20% 500, 1000 500ppm/V	10% to 30% 1000, 2000 2000ppm/V
2512 <sup>1</sup>	0.5% to 20% 25, 50, 100 25ppm/V	1% to 20% 25, 50, 100 50ppm/V	1% to 20% 100, 250 50ppm/V	2% to 20% 100, 250 100ppm/V	5% to 20% 250, 500 250ppm/V	10% to 30% 500, 1000 1000ppm/V
4020 <sup>1</sup>	0.25% to 10% 25, 50, 100 10ppm/V	0.5% to 20% 25, 50, 100 25ppm/V	1% to 20% 25, 50, 100 25ppm/V	2% to 20% 50, 100 50ppm/V	5% to 30% 100, 250 100ppm/V	10% to 30% 500, 1000 500ppm/V

<sup>1</sup> TCR in ppm/K; +25°C to +125°C; TCR below standard TCR (highest value) and values >100G; +25°C to +85°C

<sup>2</sup> VCR: typical values, all negative, not for all TCR values available

### ENVIRONMENTAL CHARACTERISTICS

Specification	Value
Solderability	250°C, 3s
Max Soldering Temperature	260°C, 10s
Climatic Category	55 / 155 / 56

Long Term Stability	Max ΔR		
	<1 G W	1 G W - 10 G W	>10 G W
Storage 125°C, 1000h	<1%	<2%	<5%
Load Life 70°C, 1000h	<0.5%	<1%	<2%
Maximum Voltage, 1000h	<0.5%	<1%	<2%



# RESISTOR THICK FILM, HIGH TEMPERATURE

## RKS SERIES

### MECHANICAL CHARACTERISTICS

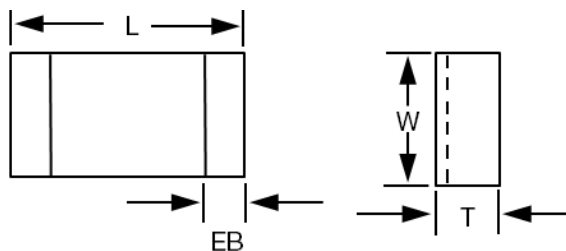

Package Size	Dimensions			
	L (Length) Inches [mm]	W (Width) Inches [mm]	T (Thickness) Inches [mm]	EB (End Band) Inches [mm]
0402	0.037 ±0.002 [ 0.95 ±0.05 ]	0.018 ±0.002 [ 0.48 ±0.10 / -0.05 ]	0.012 ±0.002 [ 0.3 ±0.05 ]	0.004 +0.004 / -0.002 [ 0.1 +0.10 / -0.05 ]
0603	0.060 +0.006 / -0.002 [ 1.5 +0.15 / -0.05 ]	0.030 +0.008 / -0.002 [ 0.8 +0.15 / -0.05 ]	0.016 +0.006 / -0.002 [ 0.4 +0.15 / -0.05 ]	0.008 +0.008 / -0.004 [ 0.2 +0.2 / -0.1 ]
0805	0.080 +0.006 / -0.002 [ 2.0 +0.15 / -0.05 ]	0.050 +0.006 / -0.002 [ 1.25 +0.15 / -0.05 ]	0.016 +0.006 / -0.002 [ 0.4 +0.15 / -0.05 ]	0.012 +0.008 / -0.004 [ 0.3 +0.2 / -0.1 ]
1206	0.126 +0.006 / -0.002 [ 3.2 +0.15 / -0.05 ]	0.060 +0.008 / -0.002 [ 1.5 +0.2 / -0.05 ]	0.016 +0.006 / -0.002 [ 0.4 +0.15 / -0.05 ]	0.012 +0.008 / -0.004 [ 0.3 +0.2 / -0.1 ]
1210	0.126 +0.006 / -0.002 [ 3.2 +0.15 / -0.05 ]	0.098 +0.008 / -0.002 [ 2.5 +0.2 / -0.05 ]	0.020 +0.006 / -0.002 [ 0.5 +0.15 / -0.05 ]	0.032 ±0.008 [ 0.8 ±0.2 ]
2512	0.250 +0.006 / -0.002 [ 6.3 +0.15 / -0.05 ]	0.138 +0.008 / -0.002 [ 3.5 +0.2 / -0.05 ]	0.024 +0.006 / -0.002 [ 0.6 +0.15 / -0.05 ]	0.035 ±0.008 [ 0.9 ±0.2 ]
4020	0.400 +0.006 / -0.002 [ 10.2 +0.15 / -0.05 ]	0.200 +0.008 / -0.002 [ 5.1 +0.2 / -0.05 ]	0.024 +0.006 / -0.002 [ 0.6 +0.15 / -0.05 ]	0.035 ±0.008 [ 0.9 ±0.2 ]

### PACKAGING INFORMATION

Bulk or Blister tape to IEC 60286-3

- ♦ Tape width 8mm / Reel Diameter 180 or 330mm
- ♦ Minimum quantity Bulk / 100 pieces per value (30 pieces per value for sizes 4020 and 2512)
- ♦ Minimum quantity Tape & Reel / 500 pieces per value  
(Note: Except size 0402 / 1000 pieces per value)

Moisture Sensitivity Level: MSL-1

This datasheet is subject to change without notice.

# RESISTOR METAL ELEMENT CURRENT SENSE

## RMC SERIES



### KEY FEATURES

- Resistances from 0.005 to 0.100 Ohms
- Low Inductance (<10nH)
- Tolerances to  $\pm 1\%$
- Resistance Wire TCR:  $\pm 20\text{ppm}/^\circ\text{C}$
- For Current Sensing and Shunt Applications
- All Welded Construction
- Economical Bare Metal Element

### APPLICATIONS

- Base Station
- Power Inverters
- Current Sensing
- Lightning Pulse Survival

### PRODUCT SUMMARY

PRODUCT SERIES (RMC)	POWER RATING @ 85°C (W)	RESISTANCE ( $\Omega$ ) <sup>1</sup>	TOLERANCES
J1	1	0.005, 0.01, 0.02, 0.025, 0.03, 0.04, 0.05, 0.1	$\pm 1\% / \pm 5\%$
J2	3	0.005, 0.01, 0.015, 0.02, 0.025, 0.03, 0.04, 0.05, 0.1	$\pm 1\% / \pm 5\%$
J3	5	0.005, 0.01, 0.015, 0.02, 0.025, 0.03, 0.05, 0.1	$\pm 1\% / \pm 5\%$

<sup>1</sup> Contact Factory for other resistances

### AVAILABLE OPTIONS (Consult Factory)

- Special Testing Requirements

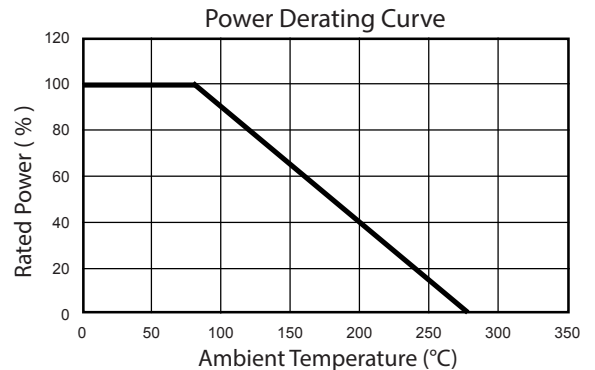

### HOW TO ORDER

RMC	J2	U	0R005	F	S
RESISTOR METAL ELEMENT CURRENT SENSE	PACKAGE CODE, WATTS	TEMPERATURE COEFFICIENT OF RESISTANCE (TCR)	RESISTANCE	TOLERANCE	PACKING
	J1, 1.0W J2, 3.0W J3, 5.0W	U = $\pm 20\text{ppm}/^\circ\text{C}$	0R005 = 0.005 $\Omega$ (5m $\Omega$ ) 0R025 = 0.025 $\Omega$ (25m $\Omega$ ) 00R05 = 0.05 $\Omega$ (50m $\Omega$ ) 000R1 = 0.1 $\Omega$ (100m $\Omega$ )	F = $\pm 1.0\%$ J = $\pm 5.0\%$	S = Bulk

Letter denotes decimal place.  
R = decimal, "K"  $10^3$ , "M"  $10^6$   
Remaining 4 digits are significant or placeholders.

For Tin/Lead coated leads, add "- Pb" to part number.  
Standard Termination Finish: Matte Tin (Sn)

Example P/N: RMCJ2U0R005FS is Resistor Metal Element Current Sense, 3.0W,  $\pm 20\text{ppm}/^\circ\text{C}$ , 0.005 $\Omega$ ,  $\pm 1.0\%$ , bulk



# RESISTOR METAL ELEMENT CURRENT SENSE

## RMC SERIES

### MECHANICAL CHARACTERISTICS

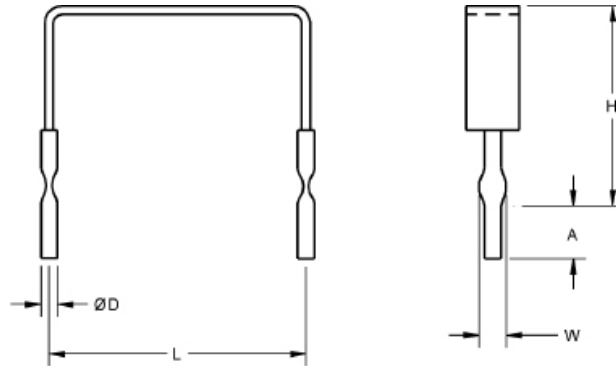

Package Code		J1	J2	J3
Dimensions Inches [mm]	H	0.200 [5.08] (Tolerances) $\pm 0.100''$ [ $\pm 2.54\text{mm}$ ]	1.0 [25.40mm] Max	1.0 [25.40mm] Max
	L (Tolerances) $+0.040 / -0.020''$ [ $+1.02 / 0.51\text{mm}$ ]	0.450 [11.43mm]	0.600 [15.24mm]	0.800 [20.32mm]
	D (Tolerances) $\pm 0.002''$ [ $\pm 0.05\text{mm}$ ]	0.040 [1.02mm]	0.040 [1.02mm]	0.040 [1.02mm]
	W (Tolerances) $+0.010 / -0.005$ [ $+0.25 / -0.13\text{mm}$ ]	0.065 [1.65mm]	0.065 [1.65mm]	0.065 [1.65mm]
	A (Tolerances) $\pm 0.030''$ [ $\pm 0.8\text{mm}$ ]	0.125 [3.18mm]	0.125 [3.18mm]	0.125 [3.18mm]

### PACKAGING INFORMATION

Package Code	J1	J2	J3
Standard Package Quantities	250 (Bulk Only)		

Moisture Sensitivity Level: MSL-1

This datasheet is subject to change without notice.



# RESISTOR POWER THIN FILM

## RHF SERIES

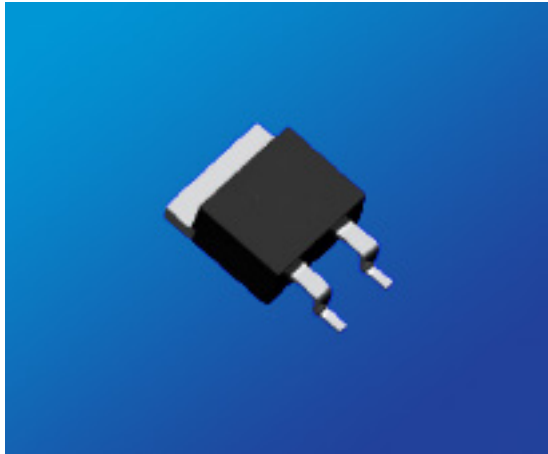

### KEY FEATURES

- Resistances from 0.01 Ohm to 51K Ohms
- Low Stability to 1%
- Resistance Tolerances to  $\pm 1\%$
- TCR to  $\pm 50\text{ppm}/^\circ\text{C}$
- Power Rating to 35 Watt
- Solder Reflow Secure at  $260^\circ\text{C} / 20\text{s}$
- TO-263 Housing (D-Pak)
- Isolated Back Plate

### APPLICATIONS

- Power Inverters
- Braking Systems
- Lighting (LED)
- Power Supplies

### PRODUCT RANGE SUMMARY

POWER RATING <sup>1</sup> (with heatsink)	RESISTANCE RANGE ( $\Omega$ )	TEMPERATURE COEFFICIENT	TOLERANCE RANGE <sup>2</sup>	OPERATING TEMPERATURE RANGE
35 W	0.01 to 0.099 $\Omega$	$\pm 250 \text{ ppm}/^\circ\text{C}$	$\pm 5\%$	-55 $^\circ\text{C}$ to +155 $^\circ\text{C}$
	0.1 to 9.9 $\Omega$	$\pm 100 \text{ ppm}/^\circ\text{C}$	$\pm 1\% / \pm 5\%$	
	10 to 51K $\Omega$	$\pm 50 \text{ ppm}/^\circ\text{C}$	$\pm 1\%$	

<sup>1</sup> 2W on simple solder pad

<sup>2</sup> Consult factory for other tolerances not listed

### HOW TO ORDER

RHF	H4	Q	038K0	F	E
RESISTOR POWER THIN FILM	PACKAGE CODE WATTS	TEMPERATURE COEFFICIENT OF RESISTANCE (TCR)	RESISTANCE	TOLERANCE	PACKING
RHF	H4, 35W, TO-263	Q = $\pm 50 \text{ ppm}/^\circ\text{C}$ N = $\pm 100 \text{ ppm}/^\circ\text{C}$ K = $\pm 250 \text{ ppm}/^\circ\text{C}$	0R038 = 0.038 $\Omega$ 003K8 = 3.8K $\Omega$ 038K0 = 38.0K $\Omega$	F = $\pm 1.0\%$ J = $\pm 5.0\%$	E = Embossed Tape & Reel

For Tin/Lead coated leads, add "-Pb" to part numbers.

Standard Termination Finish: Matte Tin (Sn)

Example P/N: RHFH4Q038K0FE is Resistor Power Thin, 35W,  $\pm 50\text{ppm}/^\circ\text{C}$ , 38.0K $\Omega$ ,  $\pm 1.0\%$ , embossed tape & reel



# RESISTOR POWER THIN FILM

## RHF SERIES

### MECHANICAL CHARACTERISTICS

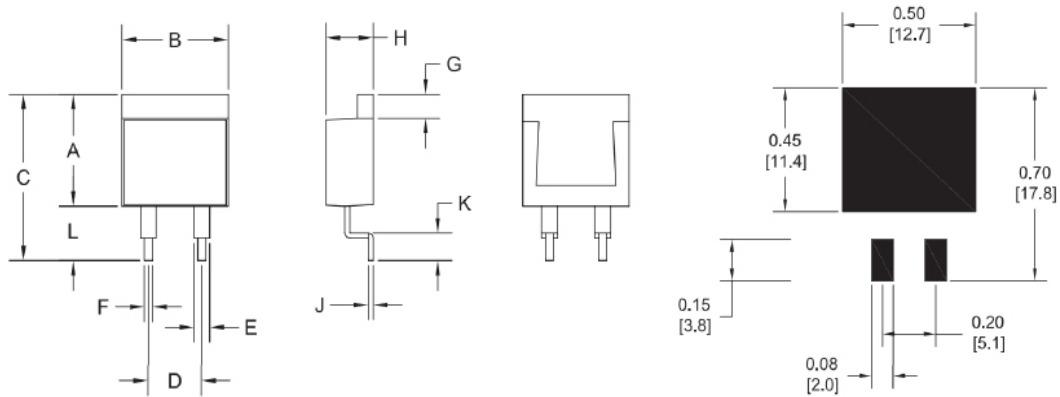

Units	Dimensions										
	A	B	C	D	E	F	G	H	J	K	L
mm	10.3	10.1	15.3	5.08	1.5	0.75	2.2	4.5	0.5	2.5	5.0
tol. (± mm)	0.2	0.2	1.0	0.1	0.05	0.05	0.2	0.2	0.05	0.5	1.0
inches	0.405	0.400	4.54	0.200	0.060	0.030	0.087	0.177	0.020	0.10	0.20
tol. (± inches)	0.008	0.008	0.04	0.004	0.002	0.002	0.008	0.008	0.002	0.02	0.04

### SPECIFICATIONS

Specifications	Values		
Resistor Material	Thin Film		
Terminals	2		
Power Rating (with heatsink)	35 W ( 2W on Simple Solder Pad )		
Inductance	8.4 nH		
Resistance Range	0.01 to 0.099Ω	0.1 to 9.9Ω	10 to 51KΩ
Temperature Coefficient	±250 ppm/°C	±100 ppm/°C	±50 ppm/°C
Tolerances (contact factory for other values)	± 5%	±1% / ±5%	±1%
Operating Temperature	-55°C to 155°C		
Thermal Resistance Rthj-c	3.3 K/W		
Max Operating Voltage	500V		
Voltage Proof	2.0kV DC		
Insulation Resistance	Over 1,000 MΩ		
Load Life	±1%	90 min ON, 30 min OFF, 1000 hrs @ 25°C	
Humidity	±1%	90-95% RH, 0.1W, 1000 hrs @ 40°C	
Temperature Cycle	±0.25%	-55°C for 30 min, +155°C for 30 min, 5 cycles	
Solder Heat	±0.1%	350°C ±5C for 3 seconds	
Vibration	±0.25%	IEC60068-2-6	
Reflow soldering	Lead-free soldering 260°C / 20s		

Moisture Sensitivity Level: MSL-1

# RESISTOR POWER THIN FILM

## RHF SERIES

### POWER RATING NOTES:

- ♦ RHF Resistors must be attached to a suitable heatsink.
- ♦ The maximum internal resistor temperature is 175°C.
- ♦ Use the following formula to specify appropriate heatsink:

$$R_{\theta H} = \frac{T_{MAX} - (P * R_{\theta R}) - T_A}{P}$$

Where:  $R_{\theta H}$  = Thermal Resistance of Heatsink ( K/W )  
 $R_{\theta R}$  = Thermal Resistance of Resistor ( K/W )  
 $T_{MAX}$  = Maximum Temperature of Resistor ( °C )  
 $T_A$  = Ambient Temperature of Heatsink ( °C )  
 $P$  = Power Through Resistor ( W )

Power Derating Curve

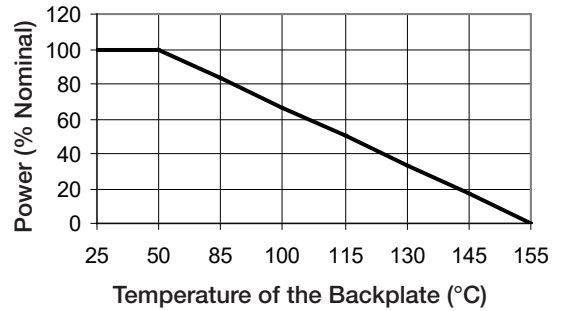

Pulse peak power (W) - 0.01 Duty Cycle

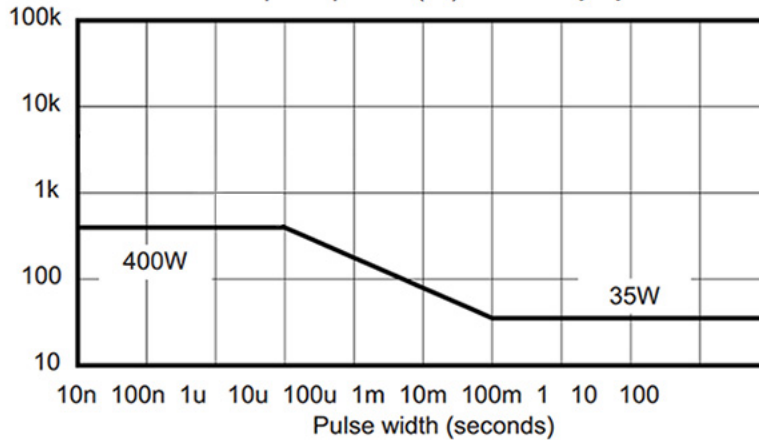

Load life test will be necessary in actual equipment

This datasheet is subject to change without notice.



# RESISTOR METAL ELEMENT SHUNTS

## RCS SERIES

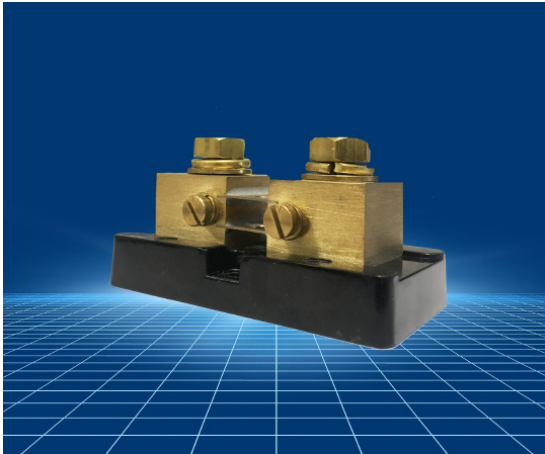

### KEY FEATURES

- Base Mounted Shunts. (Non-Base Mounted Available)
- Manganin Resistive Element
- Current Rating 5 to 1200 Amps
- Rated Output 500mV, 100mV, or Custom
- DC Current Shunts - Sizes 2013, 3318
- DC Ammeter Shunts - Size 6013

### APPLICATIONS

- |                    |                        |
|--------------------|------------------------|
| • Electroplating   | • Solar Generators     |
| • Heavy Industry   | • Wind Power           |
| • Battery Chargers | • Mining               |
| • Power Converters | • Current Measurements |

### PRODUCT SUMMARY

SIZE CODES	RATED CURRENT (A)	OPERATING CURRENT (A)	POWER RATING (W)	RESISTANCE (mΩ) 50mV Output	RESISTANCE (mΩ) 100mV Output	VOLTAGE TOLERANCE	OPERATING TEMPERATURE
21	5 - 150	3.33 - 100	0.25 - 10	0.3333 - 10.00	0.6667 - 20.00	± 0.25% Standard	-40 °C to + 60°C
32	170 - 600	113 - 400	10 - 50	.0833 - .2941	0.1667 - 0.5882	±0.1% Available	
61	1 - 500	0.667 - 333.33	.25 - 40	0.10 - 50	0.20 - 100	±0.1% Standard	30°C + 70°C

### HOW TO ORDER

<b>RCS</b>	<b>21</b>	<b>B</b>	<b>005</b>	<b>C</b>	<b>050</b>	<b>Z</b>
SERIES	SIZE CODE	BASE OR NO BASE	CURRENT RATING (AMP)	TOLERANCE	VOLTAGE OUTPUT	PACKAGING
RCS = Resistor Metal Element Shunts	21 = 2013 32 = 3318 61 = 6013	B = Base N = No Base (not available on size code 61)	005 = 5 amps 010 = 10 amps 015 = 15 amps 100 = 100 amps See Table.	B = ±0.1% C = ±0.25%	050 = 50mV 100 = 100mV	Z = Special

Example P/N: RCS21B005C050Z is Resistor Metal Element Shunts, size 2013, with base, 5 Amps, ±0.25% tolerance, 50mV, special packaging



# RESISTOR METAL ELEMENT SHUNTS

## RCS SERIES



### SIZE 2013 - DC CURRENT SHUNTS

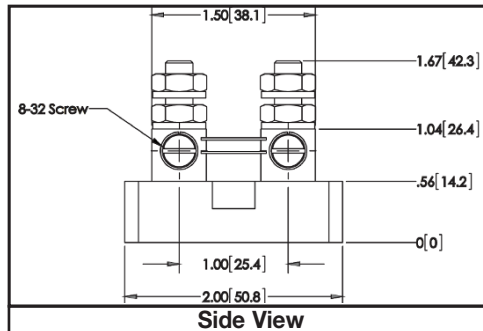
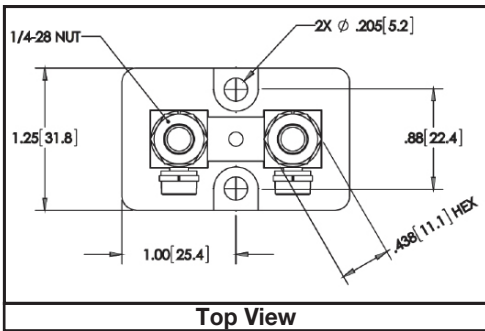

Fastener Torque = 3-3 33 ft-lbs  
(4.1-4.5 Nm)

Weight = 0.1 Kg

	Rated Current (A)	Operating Current (A)	Resistance (mΩ)		Power(W)	
			At 50mV Output	At 100mV Output	At 50mV Output	At 100mV Output
RCS21 at 5 Amps	5	3.33	10.00	20.00	0.25	0.5
RCS21 at 10 Amps	10	6.67	5.00	10.00	0.5	1
RCS21 at 15 Amps	15	10	3.333	6.667	0.75	1.5
RCS21 at 20 Amps	20	13.3	2.500	5.000	1	2
RCS21 at 30 Amps	30	20	1.667	3.333	1.5	3
RCS21 at 50 Amps	50	33.3	1.000	2.000	2.5	5
RCS21 at 75 Amps	75	50	0.667	1.333	3.75	7.5
RCS21 at 80 Amps	80	53.3	0.625	1.250	4	8
RCS21 at 85 Amps	85	56.7	0.588	1.176	4.25	8.5
RCS21 at 100 Amps	100	66.7	0.500	1.000	5	10
RCS21 at 150 Amps	150	100	0.333	0.6667	7.5	15

### SIZE 3318 - DC CURRENT SHUNTS

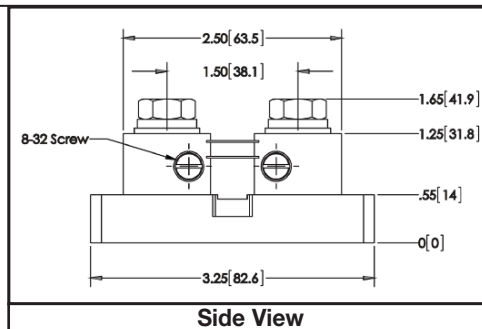
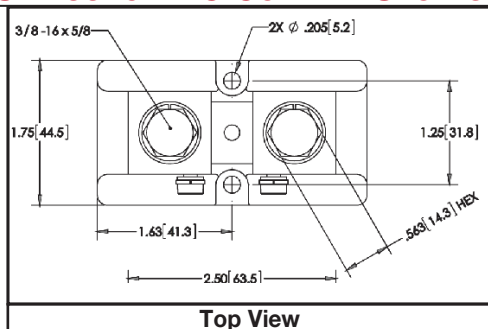

Fastener Torque = 3-3 33 ft-lbs  
(4.1-4.5 Nm)

Weight = 0.1 Kg

Part Number	Rated Current (A)	Operating Current (A)	Resistance (mΩ)		Power (W)	
			At 50mV Output	At 100mV Output	At 50mV Output	At 100mV Output
RCS32 at 170 Amps	170	113	0.2941	0.5882	8.5	17
RCS32 at 200 Amps	200	133	0.2500	0.5000	10	20
RCS32 at 250 Amps	250	166	0.2000	0.4000	12.5	25
RCS32 at 300 Amps	300	200	0.1667	0.3333	15	30
RCS32 at 400 Amps	400	267	0.1250	0.2500	20	40
RCS32 at 450 Amps	450	300	0.1111	.2222	22.5	45
RCS32 at 500 Amps	500	333	0.1000	0.2000	25	50
RCS32 at 600 Amps	600	400	0.0833	0.1667	30	60



# RESISTOR METAL ELEMENT SHUNTS

## RCS SERIES

### SIZE 6013 - DC AMMETER SHUNTS

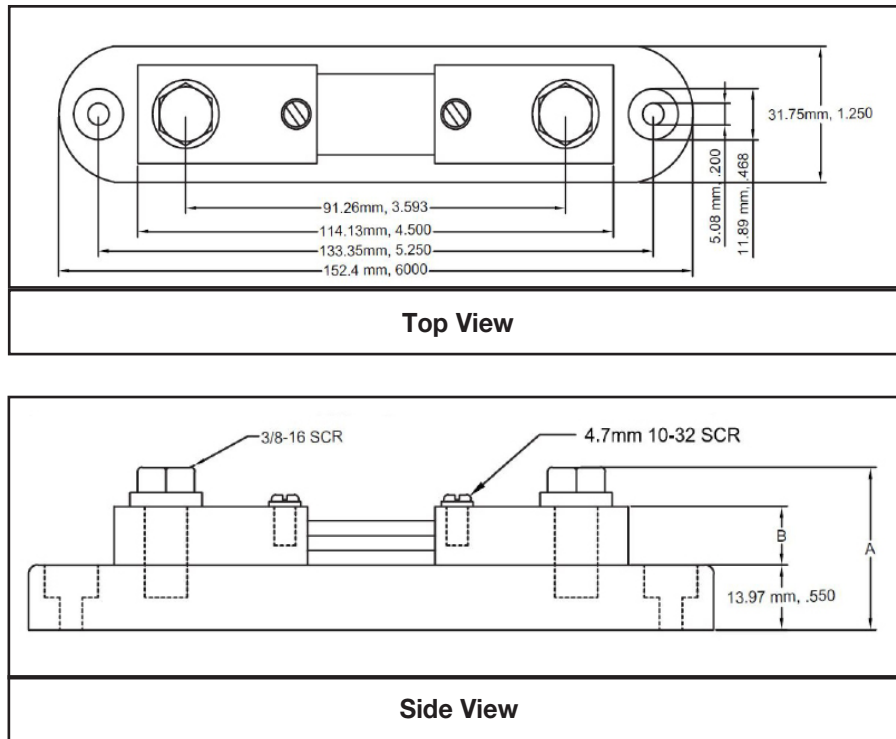

Note: No base not available on Size 6013

Part Number	Rated Current (A)	Operating Current (A)	Resistance (mΩ)		Power (W)	
			At 50mV Output	At 100mV Output	At 50mV Output	At 100mV Output
RCS61B001B	1	.667	50	100	.05	0.1
RCS61B002B	2	1.33	25	50	.2	.4
RCS61B005B	5	3.33	10	20	.25	.5
RCS61B010B	10	6.67	5.0	10	.5	1
RCS61B020B	20	13.33	2.5	5.0	1	2
RCS61B050B	50	33.33	1.0	2.0	2.5	5
RCS61B100B	100	66.67	0.5	1.0	5	10
RCS61B150B	150	100	0.333	0.667	7.5	15
RCS61B200B	200	133.33	0.25	0.50	10	20
RCS61B250B	250	166.67	0.20	0.40	12.5	25
RCS61B300B	300	200	0.167	0.333	15	30
RCS61B400B	400	266.67	0.125	0.25	20	40
RCS61B500B	500	333.33	0.10	0.20	25	50

# RESISTOR METAL ELEMENT SHUNTS

## RCS SERIES



### TECHNICAL NOTES

#### Mounting:

Shunts should be mounted with manganin resistive blades in a vertical position in order to promote the free convective flow of air. If vertical mounting is not practical, forced air cooling or adding heat sinks to the blocks can reduce the operating temperature. The manganin blades must never exceed  $+145^{\circ}\text{C}$ , otherwise permanent resistance change may occur.

When current of 100A or greater is passing through the shunt, the major portion of heat generated is dissipated by conduction through the shunt terminal blocks into the connecting buss bar or cable. Therefore, it is necessary to insure that good contact is made between the shunt terminal blocks and the conductor terminals and that the conductors have adequate cross section to keep the temperature of the shunt from exceeding  $145^{\circ}\text{C}$  ( $125^{\circ}\text{C}$  recommended).

If the shunt is mounted in an enclosure, care must be taken to ensure adequate cooling. If the power density is greater than 1/4 watt per square inch of the enclosure surface for all enclosed devices, additional cooling must be supplied in the form of air vents or fans.

Shunts also must be installed in a way that protects them from thermal expansion forces produced from buss bar or short-circuit forces. Flexible wiring may be required in high pulse current, high vibration, or high temperature applications.

Where possible, all shunts should be mounted on the ground side of the circuit. For circuits above 750VDC, RS shunts must be mounted on the ground side due to the dielectric strength of the shunt base.

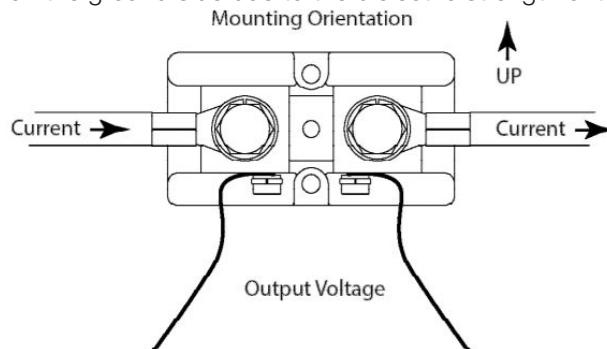

#### Operating Current Derating:

For continuous operation, it is recommended that shunts are not run at more than two thirds ( $2/3$ ) the rated current under normal conditions per IEEE standards for DC instrument shunts. At ambient temperatures above  $40^{\circ}\text{C}$ , the current must be further derated to prevent damage.

#### Pulse Operation:

Shunts that do not need continuous operation and are only exposed to intermittent pulses can be operated at levels above their rated current for short periods of times. Pulses are limited to the maximum temperature of the blades not exceeding  $145^{\circ}\text{C}$  ( $125^{\circ}\text{C}$  recommended). Many variables such as ambient temperature, cross section of the current carrying conductors, and pulse duration make calculating exact values difficult. Shunt size will need to be validated by customer for pulse current and duty cycle on a case by case basis.

This datasheet is subject to change without notice.



# POWER INDUCTORS, SEMI-SHIELDED (COATED) LPC SERIES



The Semi-shielded Power Inductor LPC Series are low profile and high current power inductors. Several dimensions are offered.

## KEY FEATURES

- High Current Performance
- Small and Low Profile Inductors
- Magnetic shielding
- Available for automatic mounting in tape and reel package

## APPLICATIONS

- DC/DC Converter
- Power Supplies
- Industrial
- Data Storage Devices
- Consumer Electronics

## PRODUCT RANGE SUMMARY

SIZE CODE	INDUCTANCE RANGE	RATED CURRENT RANGE BASED ON INDUCTANCE CHANGE	RATED CURRENT RANGE BASED ON TEMPERATURE RISE	DC RESISTANCE RANGE	OPERATING TEMPERATURE RANGE <sup>1</sup>
2410	0.68 - 22.0 $\mu$ H	0.40 - 2.60 A	0.40 - 2.50 A	60 m $\Omega$ - 1470 m $\Omega$	-25°C to +120°C
3010	1.00 - 100.0 $\mu$ H	0.15 - 2.30 A	0.18 - 2.30 A	50 m $\Omega$ - 5.00 $\Omega$	-40°C to +125°C
3012	1.00 - 47.0 $\mu$ H	0.23 - 1.90 A	0.35 - 1.71 A	45 m $\Omega$ - 1250 m $\Omega$	
3015	1.00 - 100.0 $\mu$ H	0.25 - 2.30 A	0.30 - 2.30 A	28 m $\Omega$ - 2100 m $\Omega$	
4018	0.82 - 220.0 $\mu$ H	0.30 - 4.70 A	0.28 - 4.00 A	16 m $\Omega$ - 2960 m $\Omega$	
4025	1.00 - 220.0 $\mu$ H	0.20 - 3.00 A	0.20 - 3.00 A	12 m $\Omega$ - 2300 m $\Omega$	
5040	1.50 - 47.0 $\mu$ H	1.10 - 6.00 A	0.90 - 3.60 A	15 m $\Omega$ - 270 m $\Omega$	
6045	1.00 - 220.0 $\mu$ H	0.55 - 8.60 A	0.50 - 6.50 A	10 m $\Omega$ - 920 m $\Omega$	

Consult Factory for values not listed in the product range

<sup>1</sup> Including self-generated heat

TEST FREQUENCY: 100KHz, 1V

STORAGE TEMPERATURE: -10°C to +40°C, humidity 30 to 70% R.H.

MOISTURE SENSITIVITY LEVEL: MSL - 1

Electrical Schematic: No Polarity

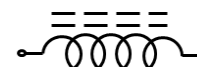

## HOW TO ORDER

LPC	3015	2R2	M	E
INDUCTOR POWER SEMI-SHIELDED	SIZE CODE	INDUCTANCE	TOLERANCE	PACKING
LPC (Coated)	2410 3010 3012 3015 4018 4025 5040 6045	R68 = 0.68 $\mu$ H 2R2 = 2.2 $\mu$ H 220 = 22 $\mu$ H 221 = 220 $\mu$ H  See chart	M = $\pm$ 20% N = $\pm$ 30%	E = Embossed Tape & Reel

Standard Termination Finish: Matte Tin(Sn)

Example P/N: LPC30152R2ME is semi-shielded power inductor 2.2  $\mu$ H, 3015 size,  $\pm$ 20%, embossed tape & reel





# POWER INDUCTORS, SEMI-SHIELDED (COATED)

## LPC SERIES

### 2410 SIZE

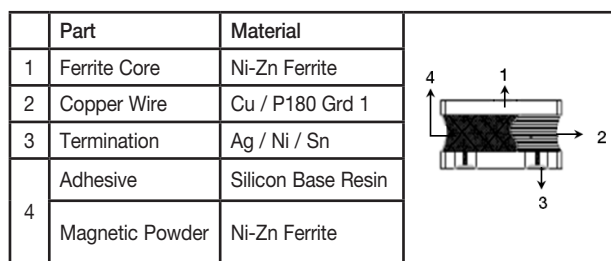
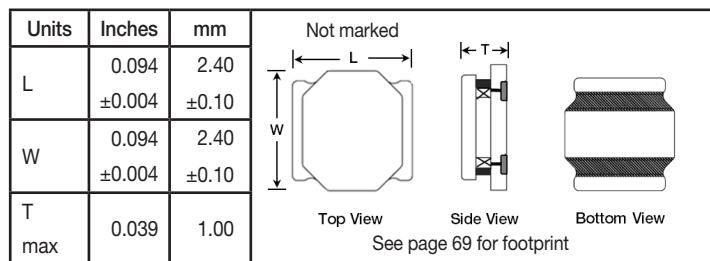

Part Number	Inductance @ 100KHz, 1V	Rated Current Based on Inductance Change <sup>*1</sup>	Rated Current Based on Temperature Rise <sup>*2</sup>	DC Resistance	DC Resistance Tolerance
LPC2410R68NE	0.68 μH, ±30%	2.60 A	2.50 A	60 mΩ	±30%
LPC24101R0NE	1.0 μH, ±30%	2.00 A	1.90 A	70 mΩ	±30%
LPC24101R5ME	1.5 μH, ±20%	1.50 A	1.50 A	110 mΩ	±20%
LPC24102R2ME	2.2 μH, ±20%	1.30 A	1.20 A	140 mΩ	±20%
LPC24103R3ME	3.3 μH, ±20%	1.05 A	1.00 A	220 mΩ	±20%
LPC24104R7ME	4.7 μH, ±20%	0.92 A	0.90 A	290 mΩ	±20%
LPC24106R8ME	6.8 μH, ±20%	0.75 A	0.65 A	410 mΩ	±20%
LPC2410100ME	10.0 μH, ±20%	0.60 A	0.55 A	690 mΩ	±20%
LPC2410150ME	15.0 μH, ±20%	0.50 A	0.45 A	1020 mΩ	±20%
LPC2410220ME	22.0 μH, ±20%	0.40 A	0.40 A	1470 mΩ	±20%

### 3010 SIZE

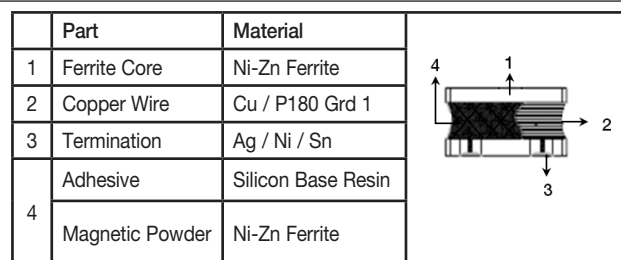
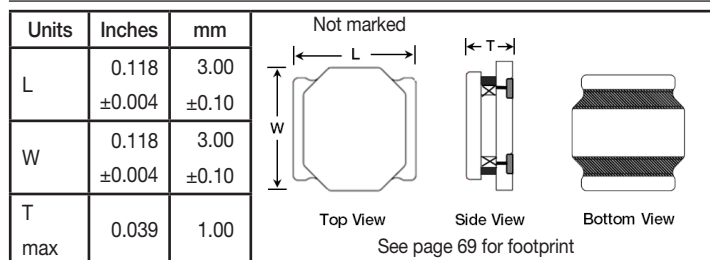

Part Number	Inductance @ 100KHz, 1V	Rated Current Based on Inductance Change <sup>*1</sup>	Rated Current Based on Temperature Rise <sup>*2</sup>	DC Resistance	DC Resistance Tolerance
LPC30101R0NE	1.0 μH, ±30%	2.30 A	2.30 A	50 mΩ	±25%
LPC30101R2NE	1.2 μH, ±30%	1.90 A	2.10 A	62 mΩ	±30%
LPC30101R5NE	1.5 μH, ±30%	1.65 A	2.00 A	70 mΩ	±30%
LPC30102R2ME	2.2 μH, ±20%	1.30 A	1.90 A	80 mΩ	±20%
LPC30103R3ME	3.3 μH, ±20%	1.05 A	1.80 A	130 mΩ	±20%
LPC30104R7ME	4.7 μH, ±20%	0.85 A	1.70 A	175 mΩ	±20%
LPC30106R8ME	6.8 μH, ±20%	0.70 A	1.30 A	260 mΩ	±20%
LPC3010100ME	10.0 μH, ±20%	0.60 A	0.90 A	350 mΩ	±20%
LPC3010150ME	15.0 μH, ±20%	0.50 A	0.80 A	510 mΩ	±20%
LPC3010220ME	22.0 μH, ±20%	0.40 A	0.70 A	780 mΩ	±20%
LPC3010330ME	33.0 μH, ±20%	0.32 A	0.50 A	1.10 Ω	±20%
LPC3010470ME	47.0 μH, ±20%	0.28 A	0.35 A	1.60 Ω	±20%
LPC3010101ME	100.0 μH, ±20%	0.15 A	0.18 A	5.00 Ω	±20%

\*1. Idc1: Based on inductance change ( $\Delta L/L_0$ :  $\leq -30\%$ )  
 \*2. Idc2: Based on temperature rise ( $\Delta T$ : 40°C TYP.)

Notes: Inductance is measured in HP-4285A Precision LCR Meter.  
 RDC measured in DU-5011 milli ohm meter (or equivalent).



# POWER INDUCTORS, SEMI-SHIELDED (COATED)

## LPC SERIES

### 3012 SIZE

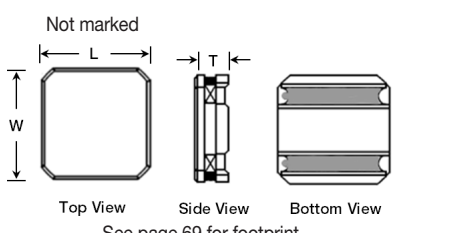
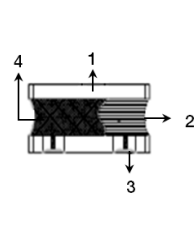
Units	Inches	mm		Part	Material		
L	0.118 ±0.004	3.00 ±0.10		1	Ferrite Core		Ni-Zn Ferrite
W	0.118 ±0.004	3.00 ±0.10		2	Copper Wire		Cu / P180 Grd 1
T max	0.047	1.20		3	Terminals		Ag / Ni / Sn
				4	Adhesive	Silicon Base Resin	
				4	Magnetic Powder	Ni-Zn Ferrite	

Part Number	Inductance @ 100KHz, 1V	Rated Current Based on Inductance Change <sup>*1</sup>	Rated Current Based on Temperature Rise <sup>*2</sup>	DC Resistance	DC Resistance Tolerance
LPC30121R0NE	1.0 µH, ±30%	1.90 A	1.71 A	45 mΩ	±20%
LPC30121R5NE	1.5 µH, ±30%	1.50 A	1.60 A	55 mΩ	±20%
LPC30122R2ME	2.2 µH, ±20%	1.25 A	1.37 A	60 mΩ	±20%
LPC30122R7ME	2.7 µH, ±20%	1.20 A	1.30 A	90 mΩ	±20%
LPC30123R3ME	3.3 µH, ±20%	1.05 A	1.21 A	90 mΩ	±20%
LPC30124R7ME	4.7 µH, ±20%	0.90 A	1.06 A	150 mΩ	±20%
LPC30126R8ME	6.8 µH, ±20%	0.70 A	0.89 A	190 mΩ	±20%
LPC3012100ME	10.0 µH, ±20%	0.60 A	0.72 A	270 mΩ	±20%
LPC3012150ME	15.0 µH, ±20%	0.50 A	0.57 A	450 mΩ	±20%
LPC3012220ME	22.0 µH, ±20%	0.40 A	0.50 A	550 mΩ	±20%
LPC3012330ME	33.0 µH, ±20%	0.30 A	0.41 A	900 mΩ	±20%
LPC3012470ME	47.0 µH, ±20%	0.23 A	0.35 A	1250 mΩ	±20%

### 3015 SIZE

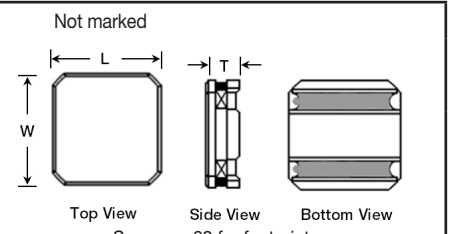
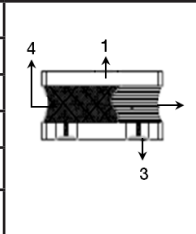
Units	Inches	mm		Part	Material		
L	0.118 ±0.004	3.00 ±0.10		1	Ferrite Core		Ni-Zn Ferrite
W	0.118 ±0.004	3.00 ±0.10		2	Copper Wire		Cu / P180 Grd 1
T max	0.059	1.50		3	Termination		Ag / Ni / Sn
				4	Adhesive	Silicon Base Resin	
				4	Magnetic Powder	Ni-Zn Ferrite	

Part Number	Inductance @ 100KHz, 1V	Rated Current Based on Inductance Change <sup>*1</sup>	Rated Current Based on Temperature Rise <sup>*2</sup>	DC Resistance	DC Resistance Tolerance
LPC30151R0NE	1.0 µH, ±30%	2.30 A	2.30 A	28 mΩ	±30%
LPC30151R5NE	1.5 µH, ±30%	2.10 A	2.10 A	37 mΩ	±30%
LPC30152R2ME	2.2 µH, ±20%	1.62 A	2.00 A	58 mΩ	±20%
LPC30152R7ME	2.7 µH, ±20%	1.50 A	1.95 A	60 mΩ	±20%
LPC30153R3ME	3.3 µH, ±20%	1.35 A	1.80 A	75 mΩ	±20%
LPC30154R7ME	4.7 µH, ±20%	1.20 A	1.60 A	100 mΩ	±20%
LPC30155R6ME	5.6 µH, ±20%	1.00 A	1.40 A	120 mΩ	±20%
LPC30156R8ME	6.8 µH, ±20%	0.97 A	1.30 A	150 mΩ	±20%
LPC3015100ME	10.0 µH, ±20%	0.80 A	1.10 A	220 mΩ	±20%
LPC3015150ME	15.0 µH, ±20%	0.65 A	1.00 A	300 mΩ	±20%

\*1. I<sub>dc1</sub>: Based on inductance change ( $\Delta L/L_0$ : ≤ -30%)  
 \*2. I<sub>dc2</sub>: Based on temperature rise ( $\Delta T$ : 40°C TYP.)

Notes: Inductance is measured in HP-4285A Precision LCR Meter.  
 RDC measured in DU-5011 milli ohm meter (or equivalent).

# POWER INDUCTORS, SEMI-SHIELDED (COATED)

## LPC SERIES

### 3015 SIZE (CONTINUED)

Part Number	Inductance @ 100KHz, 1V	Rated Current Based <sup>*1</sup> on Inductance Change	Rated Current Based <sup>*2</sup> on Temperature Rise	DC Resistance	DC Resistance Tolerance
LPC3015180ME	18.0 µH, ±20%	0.57 A	0.90 A	410 mΩ	±20%
LPC3015220ME	22.0 µH, ±20%	0.55 A	0.80 A	475 mΩ	±20%
LPC3015330ME	33.0 µH, ±20%	0.45 A	0.70 A	650 mΩ	±20%
LPC3015390ME	39.0 µH, ±20%	0.40 A	0.50 A	850 mΩ	±20%
LPC3015470ME	47.0 µH, ±20%	0.35 A	0.45 A	1100 mΩ	±20%
LPC3015680ME	68.0 µH, ±20%	0.30 A	0.35 A	1700 mΩ	±20%
LPC3015820ME	82.0 µH, ±20%	0.27 A	0.32 A	1900 mΩ	±20%
LPC3015101ME	100.0 µH, ±20%	0.25 A	0.30 A	2100 mΩ	±20%

### 4018 SIZE

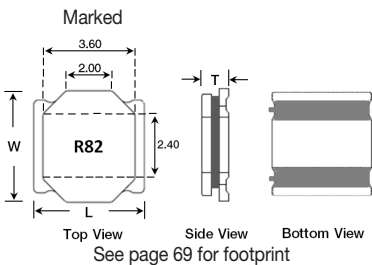
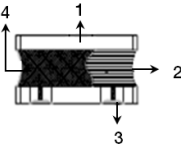
Units	Inches	mm				Part	Material	
L	0.157 ±0.008	4.00 ±0.20	Marked 3.60 2.00 2.40 L W R82 Top View Side View Bottom View See page 69 for footprint	1	Ferrite Core	Ni-Zn Ferrite		
W	0.157 ±0.008	4.00 ±0.20		2	Copper Wire	Cu / P180 Grd 1		
T max	(R82-2R7)	0.074		1.88	3	Termination	Ag / Ni / Sn	
	(3R3-221)	0.071		1.80	4	Adhesive	Silicon Base Resin	
					Magnetic Powder	Ni-Zn Ferrite		

Part Number	Inductance @ 100KHz, 1V	Rated Current Based <sup>*1</sup> on Inductance Change	Rated Current Based <sup>*2</sup> on Temperature Rise	DC Resistance	DC Resistance Tolerance	Marking
LPC4018R82NE	0.82 µH, ±30%	4.20 A	4.00 A	16 mΩ	±30%	R82
LPC40181R0NE	1.0 µH, ±30%	4.70 A	3.70 A	19 mΩ	±30%	1R0
LPC40181R2NE	1.2 µH, ±30%	4.00 A	3.50 A	21 mΩ	±30%	1R2
LPC40181R5NE	1.5 µH, ±30%	3.50 A	3.10 A	27 mΩ	±30%	1R5
LPC40182R2ME	2.2 µH, ±20%	3.00 A	2.90 A	37 mΩ	±20%	2R2
LPC40182R7ME	2.7 µH, ±20%	2.40 A	2.30 A	43 mΩ	±20%	2R7
LPC40183R3ME	3.3 µH, ±20%	2.30 A	2.20 A	55 mΩ	±20%	3R3
LPC40184R7ME	4.7 µH, ±20%	2.00 A	1.90 A	70 mΩ	±20%	4R7
LPC40186R8ME	6.8 µH, ±20%	1.60 A	1.50 A	98 mΩ	±20%	6R8
LPC4018100ME	10.0 µH, ±20%	1.40 A	1.30 A	150 mΩ	±20%	100
LPC4018150ME	15.0 µH, ±20%	1.10 A	1.00 A	220 mΩ	±20%	150
LPC4018220ME	22.0 µH, ±20%	0.95 A	0.90 A	290 mΩ	±20%	220
LPC4018330ME	33.0 µH, ±20%	0.75 A	0.70 A	460 mΩ	±20%	330
LPC4018470ME	47.0 µH, ±20%	0.62 A	0.60 A	650 mΩ	±20%	470
LPC4018680ME	68.0 µH, ±20%	0.50 A	0.50 A	940 mΩ	±20%	680
LPC4018101ME	100.0 µH, ±20%	0.45 A	0.42 A	1330 mΩ	±20%	101
LPC4018151ME	150.0 µH, ±20%	0.35 A	0.32 A	2000 mΩ	±20%	151
LPC4018221ME	220.0 µH, ±20%	0.30 A	0.28 A	2960 mΩ	±20%	221

\*1. Idc1: Based on inductance change ( $\Delta L/L_0$ :  $\leq -30\%$ )

\*2. Idc2: Based on temperature rise ( $\Delta T$ : 40°C TYP.)

Notes: Inductance is measured in HP-4285A Precision LCR Meter.  
RDC measured in DU-5011 milli ohm meter (or equivalent).



# POWER INDUCTORS, SEMI-SHIELDED (COATED)



## LPC SERIES

### 4025 SIZE

Units	Inches	mm
L	0.157 ±0.008	4.00 ±0.20
W	0.157 ±0.008	4.00 ±0.20
T max	0.098	2.50

Marked

Top View

Side View

Bottom View

See page 69 for footprint

Part	Material
1	Ferrite Core Ni-Zn Ferrite
2	Copper Wire Cu / P180 Grd 1
3	Terminals Ag / Ni / Sn
4	Adhesive Silicon Base Resin
	Magnetic Powder Ni-Zn Ferrite

Part Number	Inductance @ 100KHz, 1V	Rated Current Based on Inductance Change <sup>*1</sup>	Rated Current Based on Temperature Rise <sup>*2</sup>	DC Resistance	DC Resistance Tolerance	Marking
LPC40251R0NE	1.0 µH, ±30%	3.00 A	3.00 A	12 mΩ	±30%	1R0
LPC40251R2NE	1.2 µH, ±30%	2.75 A	2.75 A	18 mΩ	±30%	1R2
LPC40252R2NE	2.2 µH, ±30%	2.10 A	2.10 A	22 mΩ	±30%	2R2
LPC40253R3ME	3.3 µH, ±20%	1.60 A	1.60 A	30 mΩ	±20%	3R3
LPC40254R7ME	4.7 µH, ±20%	1.40 A	1.40 A	40 mΩ	±20%	4R7
LPC40256R8ME	6.8 µH, ±20%	1.20 A	1.20 A	70 mΩ	±20%	6R8
LPC4025100ME	10.0 µH, ±20%	0.97 A	0.97 A	85 mΩ	±20%	100
LPC4025150ME	15.0 µH, ±20%	0.77 A	0.77 A	120 mΩ	±20%	150
LPC4025220ME	22.0 µH, ±20%	0.67 A	0.67 A	195 mΩ	±20%	220
LPC4025330ME	33.0 µH, ±20%	0.50 A	0.50 A	305 mΩ	±20%	330
LPC4025470ME	47.0 µH, ±20%	0.40 A	0.40 A	495 mΩ	±20%	470
LPC4025680ME	68.0 µH, ±20%	0.35 A	0.35 A	710 mΩ	±20%	680
LPC4025101ME	100.0 µH, ±20%	0.30 A	0.30 A	1000 mΩ	±20%	101
LPC4025151ME	150.0 µH, ±20%	0.22 A	0.22 A	1600 mΩ	±20%	151
LPC4025221ME	220.0 µH, ±20%	0.20 A	0.20 A	2300 mΩ	±20%	121

### 5040 SERIES

Units	Inches	mm
L	0.197 ±0.008	5.00 ±0.20
W	0.197 ±0.008	5.00 ±0.20
T max	.157	4.00

Marked

Top View

Side View

Bottom View

See page 69 for footprint

Part	Material
1	Ferrite Core Ni-Zn Ferrite
2	Copper Wire Cu / P180 Grd 1
3	Termination Ag / Ni / Sn
4	Adhesive Silicon Base Resin
	Magnetic Powder Ni-Zn Ferrite

Part Number	Inductance @ 100KHz, 1V	Rated Current Based on Inductance Change <sup>*1</sup>	Rated Current Based on Temperature Rise <sup>*2</sup>	DC Resistance	DC Resistance Tolerance	Marking
LPC50401R5NE	1.5 µH, ±30%	6.00 A	3.60 A	15 mΩ	±20%	1R5
LPC50402R2NE	2.2 µH, ±30%	4.60 A	3.50 A	17 mΩ	±20%	2R2
LPC50403R3ME	3.3 µH, ±20%	3.80 A	3.30 A	22 mΩ	±20%	3R3
LPC50404R7ME	4.7 µH, ±20%	3.30 A	3.10 A	29 mΩ	±20%	4R7
LPC50406R8ME	6.8 µH, ±20%	2.60 A	2.30 A	49 mΩ	±20%	6R8
LPC50408R2ME	8.2 µH, ±20%	2.40 A	2.20 A	54 mΩ	±20%	8R2
LPC5040100ME	10.0 µH, ±20%	2.30 A	2.10 A	56 mΩ	±20%	100

\*1. Idc1: Based on inductance change ( $\Delta L/L_0 \leq -30\%$ )  
 \*2. Idc2: Based on temperature rise ( $\Delta T: 40^\circ\text{C TYP.}$ )

Notes: Inductance is measured in HP-4285A Precision LCR Meter.  
 RDC measured in DU-5011 milli ohm meter (or equivalent).



# POWER INDUCTORS, SEMI-SHIELDED (COATED)

## LPC SERIES

### 5040 SIZE (CONTINUED)

Part Number	Inductance @ 100KHz, 1V	Rated Current Based <sup>*1</sup> on Inductance Change	Rated Current Based <sup>*2</sup> on Temperature Rise	DC Resistance	DC Resistance Tolerance	Marking
LPC5040150ME	15.0 $\mu$ H, $\pm$ 20%	2.00 A	1.80 A	80 m $\Omega$	$\pm$ 20%	150
LPC5040220ME	22.0 $\mu$ H, $\pm$ 20%	1.60 A	1.40 A	126 m $\Omega$	$\pm$ 20%	220
LPC5040270ME	27.0 $\mu$ H, $\pm$ 20%	1.40 A	1.30 A	165 m $\Omega$	$\pm$ 20%	270
LPC5040330ME	33.0 $\mu$ H, $\pm$ 20%	1.30 A	1.20 A	180 m $\Omega$	$\pm$ 20%	330
LPC5040470ME	47.0 $\mu$ H, $\pm$ 20%	1.10 A	0.90 A	270 m $\Omega$	$\pm$ 20%	470

### 6045 SIZE

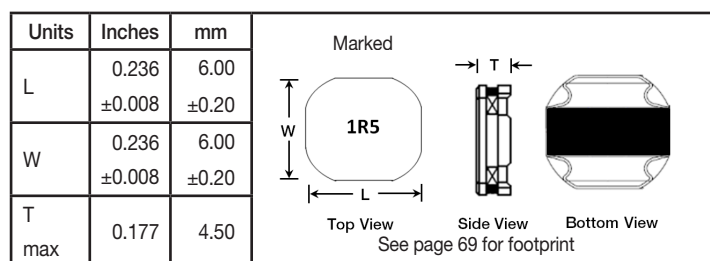

	Part	Material
1	Ferrite Core	Ni-Zn Ferrite
2	Copper Wire	Cu / P180 Grd 1
3	Terminals	Ag / Ni / Sn
4	Adhesive	Silicon Base Resin
	Magnetic Powder	Ni-Zn Ferrite

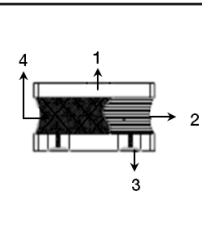

Part Number	Inductance @ 100KHz, 1V	Rated Current Based <sup>*1</sup> on Inductance Change	Rated Current Based <sup>*2</sup> on Temperature Rise	DC Resistance	DC Resistance Tolerance	Marking
LPC60451R0NE	1.0 $\mu$ H, $\pm$ 30%	8.60 A	6.50 A	10 m $\Omega$	$\pm$ 30%	1R0
LPC60451R3NE	1.3 $\mu$ H, $\pm$ 30%	8.00 A	6.00 A	11m $\Omega$	$\pm$ 30%	1R3
LPC60451R8NE	1.8 $\mu$ H, $\pm$ 30%	7.00 A	5.30 A	12 m $\Omega$	$\pm$ 30%	1R8
LPC60452R2NE	2.2 $\mu$ H, $\pm$ 30%	6.10 A	5.00 A	13 m $\Omega$	$\pm$ 30%	2R2
LPC60453R0NE	3.0 $\mu$ H, $\pm$ 30%	5.00 A	4.80 A	17 m $\Omega$	$\pm$ 30%	3R0
LPC60453R3NE	3.3 $\mu$ H, $\pm$ 30%	4.50 A	4.50 A	17 m $\Omega$	$\pm$ 30%	3R3
LPC60454R5NE	4.5 $\mu$ H, $\pm$ 30%	4.30 A	3.80 A	23 m $\Omega$	$\pm$ 30%	4R5
LPC60454R7NE	4.7 $\mu$ H, $\pm$ 30%	4.00 A	3.70 A	23 m $\Omega$	$\pm$ 30%	4R7
LPC60455R6NE	5.6 $\mu$ H, $\pm$ 30%	3.80 A	3.60 A	26 m $\Omega$	$\pm$ 30%	5R6
LPC60456R3NE	6.3 $\mu$ H, $\pm$ 30%	3.80 A	3.60 A	26 m $\Omega$	$\pm$ 30%	6R3
LPC60456R8NE	6.8 $\mu$ H, $\pm$ 30%	3.60 A	3.50 A	34 m $\Omega$	$\pm$ 30%	6R8
LPC60458R2NE	8.2 $\mu$ H, $\pm$ 30%	3.20 A	3.10 A	41 m $\Omega$	$\pm$ 30%	8R2
LPC6045100ME	10.0 $\mu$ H, $\pm$ 20%	3.10 A	3.00 A	45 m $\Omega$	$\pm$ 20%	100
LPC6045150ME	15.0 $\mu$ H, $\pm$ 20%	2.30 A	2.30 A	80 m $\Omega$	$\pm$ 20%	150
LPC6045220ME	22.0 $\mu$ H, $\pm$ 20%	1.90 A	1.90 A	112 m $\Omega$	$\pm$ 20%	220
LPC6045330ME	33.0 $\mu$ H, $\pm$ 20%	1.50 A	1.50 A	170 m $\Omega$	$\pm$ 20%	330
LPC6045470ME	47.0 $\mu$ H, $\pm$ 20%	1.30 A	1.30 A	210 m $\Omega$	$\pm$ 20%	470
LPC6045560ME	56.0 $\mu$ H, $\pm$ 20%	1.20 A	1.20 A	270 m $\Omega$	$\pm$ 20%	560
LPC6045680ME	68.0 $\mu$ H, $\pm$ 20%	1.00 A	1.00 A	325 m $\Omega$	$\pm$ 20%	680
LPC6045101ME	100.0 $\mu$ H, $\pm$ 20%	0.90 A	0.90 A	460 m $\Omega$	$\pm$ 20%	101
LPC6045221ME	220.0 $\mu$ H, $\pm$ 20%	0.55 A	0.50 A	920 m $\Omega$	$\pm$ 20%	221

\*1. Idc1: Based on inductance change ( $\Delta L/L_0$ :  $\leq$  -30%)  
 \*2. Idc2: Based on temperature rise ( $\Delta T$ : 40°C TYP.)

Notes: Inductance is measured in HP-4285A Precision LCR Meter.  
 RDC measured in DU-5011 milli ohm meter (or equivalent).



# POWER INDUCTORS, SEMI-SHIELDED (COATED)



## LPC SERIES

### ENVIRONMENTAL PERFORMANCE

	SPECIFICATION	TEST PARAMETERS
VIBRATION	$\Delta L/L_0 : \leq \pm 10\%$ There shall be no mechanical damage	Solder specimen inductor on the test printed circuit board. Apply vibrations in each of the x, y and z directions for 2 hours for a total of 6 hours. Frequency : 10 to 50 Hz    Amplitude : 1.5mm
SOLDERABILITY	The metalized area must have 90% minimum solder coverage.	Dip pads in flux and dip in solder pot (NP303) at $240^\circ\text{C} \pm 5^\circ\text{C}$
HIGH TEMPERATURE RESISTANCE	$\Delta L/L_0 : \leq \pm 10\%$ There shall be no mechanical damage or electrical damage.	The sample shall be left for 96 hours in an atmosphere with a temperature of $85 \pm 2^\circ\text{C}$ and a normal humidity. Upon completion of the test, the measurement shall be made after the sample has been left in a normal temperature and normal humidity for 1 hour.
LOW TEMPERATURE	$\Delta L/L_0 : \leq \pm 10\%$ There shall be no mechanical damage or electrical damage.	The sample shall be left for 96 hours in an atmosphere with a temperature of $-30 \pm 2^\circ\text{C}$ . Upon completion of the test, the measurement shall be made after the sample has been left in a normal temperature and normal humidity for 1 hour.
MOISTURE STORAGE	$\Delta L/L_0 : \leq \pm 10\%$ There shall be no mechanical damage	The sample shall be left for 96 hours in a temperature of $40 \pm 2^\circ\text{C}$ and a humidity(RH) of 90~95%. Upon completion of the test, the measurement shall be made after the sample has been left in a normal temperature and normal humidity more than 1 hour.
SUBSTRATE BENDING	$\Delta L/L_0 : \leq \pm 10\%$ There shall be no mechanical damage or electrical damage	The sample shall be soldered onto the printed circuit board and a load applied until the figure in the arrow direction is made approximately 3mm (keep time $5 \pm 1$ seconds).
THERMAL SHOCK	$\Delta L/L_0 : \leq \pm 10\%$ There shall be no damage or problems.	The sample shall be subject to 5 continuous cycles, such as shown in the following temperature cycle. Measure the test items after leaving the inductors at room temperature and humidity for 1 hour.
COMPONENT ADHESION (PUSH TEST)	10N Min (LPC 2410, 3010) 12N Min (LPC 3012, 3015, 4018, 4025, 5040, 6045)	The device should be reflow soldered ( $245 \pm 5^\circ\text{C}$ for 10 seconds) to a copper substrate a dynamometer force gauge should be applied to the side of the component the device must withstand a minimum force of 10N or 12N without failure of the termination attached to the component.

# POWER INDUCTORS, SEMI-SHIELDED (COATED)



## LPC SERIES

### SOLDERING INFORMATION

#### RECOMMENDED FOOTPRINT:

Dimensions	Units	SIZE CODES							
		2410	3010	3012	3015	4018	4025	5040	6045
A	In	0.031	0.031	0.031	0.031	0.059	0.059	0.059	0.063
	mm	0.800	0.800	0.800	0.800	1.500	1.500	1.500	1.600
B	In	0.079	0.079	0.106	0.106	0.142	0.142	0.157	0.244
	mm	2.000	2.000	2.700	2.700	3.600	3.600	4.000	5.700
C	In	0.098	0.098	0.087	0.087	0.179	0.179	0.201	0.248
	mm	2.500	2.500	2.200	2.200	4.550	4.550	5.100	6.300

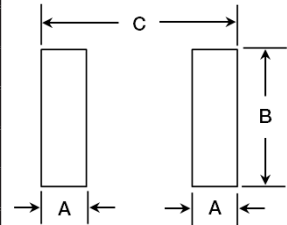

#### RECOMMENDED SOLDER ATTACHMENT: REFLOW SOLDERING

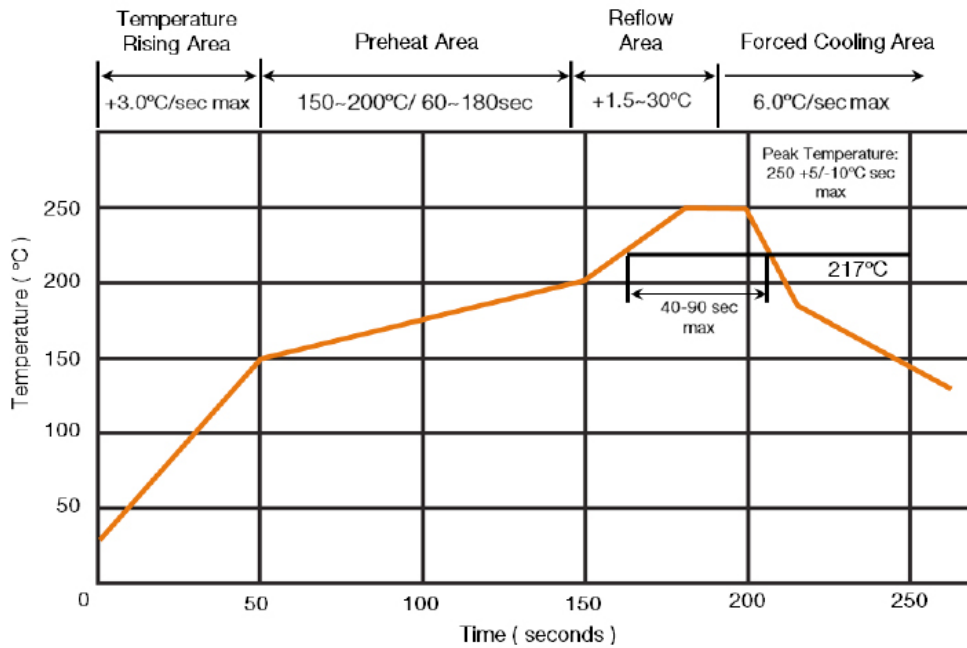

Reflow: 2 times max  
 Peak Temperature: 255°C  
 Max Time Above 217°C: 90 sec max

#### If hand soldering must be used, follow these precautions:

Use solder iron of less than 30W when soldering.  
 Do not allow soldering iron tip to directly touch the ferrite body outside of the terminal electrode.  
 2 seconds maximum at 280°C.

\* This datasheet is subject to change without notice



# POWER INDUCTORS, SHIELDED

## LPM SERIES



The Shielded Power LPM Series are low profile, surface-mount inductors. They are designed for power applications or high current applications.

### KEY FEATURES

- High reliability and easy surface mount assembly
- Low loss due to design of low DC resistance
- Low profile with max thickness 3.0 mm
- Frequency Application Up to 3MHz
- Suitable for reflow soldering
- 100% Lead Free

### APPLICATIONS

- Low profile and high current power supplies
- DC/DC Converters

### PRODUCT RANGE SUMMARY

SIZE CODE	INDUCTANCE RANGE	RATED CURRENT RANGE BASED ON INDUCTANCE CHANGE	RATED CURRENT RANGE BASED ON TEMPERATURE RISE	DC RESISTANCE RANGE (TYPICAL)	OPERATING TEMPERATURE RANGE
0520	1.00 - 10.0 $\mu$ H	2.10 - 8.00 A	2.30 - 7.50 A	16.80 m $\Omega$ - 140.00 m $\Omega$	-55°C to +125°C
0530	0.60 - 5.6 $\mu$ H	4.00 - 18.00 A	4.00 - 9.80 A	11.00 m $\Omega$ - 55.00 m $\Omega$	
0630	0.47 - 22 $\mu$ H	2.50 - 20.50 A	2.50 - 16.50 A	3.50 m $\Omega$ - 152.00 m $\Omega$	

Consult Factory for values not listed in the product range

### HOW TO ORDER

LPM	0520	LR	1R0	M	E
INDUCTOR POWER SHIELDED	SIZE CODE	APPLICATION TYPE	INDUCTANCE	TOLERANCE	PACKING
LPM (Shielded)	0520 0530 0630	LR = Power application with lower DC resistance and lower power loss design requirement HI = High performance application with high saturation current requirement	1R0 = 1.00 $\mu$ H See chart	M = $\pm$ 20%	E = Embossed Tape & Reel

Standard Termination Finish: Matte Tin(Sn)

Example P/N: LPM0520LR1R0ME is shielded power inductor, size 0520 for low power applications, 1.00 $\mu$ H,  $\pm$ 20%, embossed tape & reel

Note: See our website for Saturation Current and Heat Rating Current Performance graphs.



# POWER INDUCTORS, SHIELDED

## LPM SERIES

### 0520 SIZE

Units	Inches	mm
L	0.220 ± 0.001	5.60 ± 0.35
W	0.205 ± 0.008	5.20 ± 0.20
H	0.079 ± 0.004	2.00 ± 0.10
A	0.039 ± 0.016	1.00 ± 0.40
A'	0.059 ± 0.004	1.50 ± 0.10
B	0.079 ± 0.012	2.00 ± 0.30
B'	0.098 ± 0.008	2.50 ± 0.20

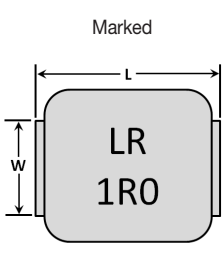

Marked  
Top View

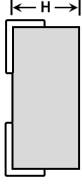

Side View

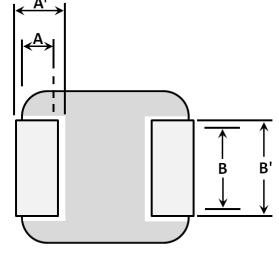

Bottom View

Application Type	Marking
LR	LR 1R0
HI	1R0

Part Number	Inductance	Rated Current		SRF (Typ)	DC Resistance		Marking
		Based on Inductance Change <sup>*1</sup>	Based on Temperature Rise <sup>*2</sup>		Typ	Max	
LPM0520LR1R0ME	1.00 µH, ±20%	8.00 A	7.50 A	65 MHz	16.8 mΩ	18.5 mΩ	LR 1R0
LPM0520LR1R5ME	1.50 µH, ±20%	6.80 A	5.80 A	46 MHz	19.0 mΩ	24.0 mΩ	LR 1R5
LPM0520LR2R2ME	2.20 µH, ±20%	5.00 A	5.50 A	38 MHz	33.0 mΩ	36.0 mΩ	LR 2R2
LPM0520LR3R3ME	3.30 µH, ±20%	4.20 A	4.50 A	34 MHz	45.0 mΩ	50.0 mΩ	LR 3R3
LPM0520LR4R7ME	4.70 µH, ±20%	3.70 A	3.70 A	27 MHz	52.0 mΩ	58.0 mΩ	LR 4R7
LPM0520LR5R6ME	5.60 µH, ±20%	3.30 A	3.50 A	22 MHz	65.0 mΩ	75.0 mΩ	LR 5R6
LPM0520LR100ME	10.00 µH, ±20%	2.10 A	3.00 A	17 MHz	130.0 mΩ	145.0 mΩ	LR 100
LPM0520HI100ME	10.00 µH, ±20%	4.00 A	2.30 A	16 MHz	140.0 mΩ	150.0 mΩ	100

### 0530 SIZE

Units	Inches	mm
L	0.220 ± 0.001	5.60 ± 0.35
W	0.205 ± 0.008	5.20 ± 0.20
H	0.118	3.00 (max)
A	0.039 ± 0.016	1.00 ± 0.40
A'	0.059 ± .004	1.50 ± 0.10
B	0.079 ± 0.012	2.00 ± 0.30
B'	0.098 ± 0.079	2.50 ± 0.20

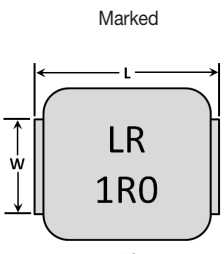

Marked  
Top View

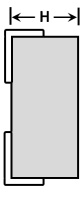

Side View

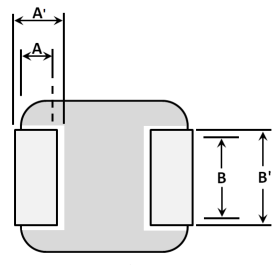

Bottom View

Application Type	Marking
LR	LR 1R0
HI	1R0

Part Number	Inductance	Rated Current		SRF (Typ)	DC Resistance		Marking
		Based on Inductance Change <sup>*1</sup>	Based on Temperature Rise <sup>*2</sup>		Typ	Max	
LPM0530HIR60ME	0.60 µH, ±20%	18.00 A	9.80 A	84 MHz	11.0 mΩ	12.0 mΩ	R60
LPM0530HIR68ME	0.68 µH, ±20%	16.00 A	9.50 A	63 MHz	11.0 mΩ	12.0 mΩ	R68
LPM0530HIR82ME	0.82 µH, ±20%	12.50 A	9.00 A	53 MHz	14.0 mΩ	15.0 mΩ	R82
LPM0530HI1R0ME	1.00 µH, ±20%	14.00 A	7.00 A	52 MHz	13.0 mΩ	14.0 mΩ	1R0
LPM0530HI1R2ME	1.20 µH, ±20%	13.00 A	6.80 A	48 MHz	15.5 mΩ	16.5 mΩ	1R2
LPM0530HI1R5ME	1.50 µH, ±20%	10.00 A	6.00 A	44 MHz	20.0 mΩ	25.0 mΩ	1R5
LPM0530HI2R2ME	2.20 µH, ±20%	9.00 A	5.50 A	30 MHz	29.0 mΩ	35.0 mΩ	2R2
LPM0530LR1R5ME	1.50 µH, ±20%	7.00 A	8.00 A	44 MHz	18.50 mΩ	20.0 mΩ	LR 1R5

\*1. Isat: Based on inductance change ( $\Delta L/L_0$ : -20% TYP.)  
 \*2. I<sub>rms</sub>: Based on temperature rise ( $\Delta T$ : 40°C TYP.)

Notes: Inductance is measured in HP-4284A Precision LCR Meter.  
 RDC measured in HP 4338B milliohm meter ( or equivalent)



# POWER INDUCTORS, SHIELDED

## LPM SERIES

### 0530 SIZE (CONTINUED)

Part Number	Inductance	Rated Current		SRF (Typ)	DC Resistance		Marking
		Based on Inductance Change <sup>*1</sup>	Based on Temperature Rise <sup>*2</sup>		Typ	Max	
LPM0530LR2R2ME	2.20 $\mu$ H, $\pm$ 20%	5.50 A	7.00 A	38 MHz	24.0 m $\Omega$	26.0 m $\Omega$	LR 2R2
LPM0530LR3R3ME	3.30 $\mu$ H, $\pm$ 20%	5.00 A	6.50 A	28 MHz	32.0 m $\Omega$	36.0 m $\Omega$	LR 3R3
LPM0530LR4R7ME	4.70 $\mu$ H, $\pm$ 20%	4.50 A	4.50 A	25 MHz	54.0 m $\Omega$	60.0 m $\Omega$	LR 4R7
LPM0530LR5R6ME	5.60 $\mu$ H, $\pm$ 20%	4.00 A	4.50 A	19 MHz	55.0 m $\Omega$	65.0 m $\Omega$	LR 5R6

### 0630 SIZE

Units	Inches	mm
L	0.283 $\pm$ 0.012	7.20 $\pm$ 0.30
W	0.262 $\pm$ 0.008	6.65 $\pm$ 0.20
H	0.119	3.00 (max)
A	0.063 $\pm$ 0.016	1.60 $\pm$ 0.40
A'	0.079 $\pm$ 0.004	2.00 $\pm$ 0.10
B	0.119 $\pm$ 0.013	3.00 $\pm$ 0.30
B'	0.134 $\pm$ 0.008	3.40 $\pm$ 0.20

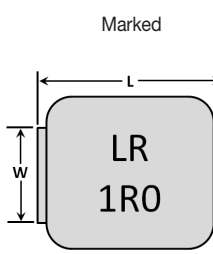

Marked  
Top View

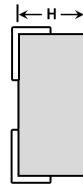

Side View

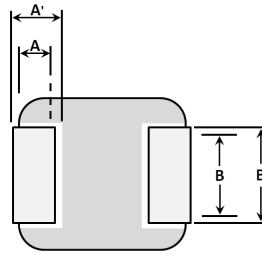

Bottom View

Application Type	Marking
LR	LR 1R0
HI	1R0

Part Number	Inductance	Rated Current		SRF (Typ)	DC Resistance		Marking
		Based on Inductance Change <sup>*1</sup>	Based on Temperature Rise <sup>*2</sup>		Typ	Max	
LPM0630LRR47ME	0.47 $\mu$ H, $\pm$ 20%	20.00 A	16.50 A	79 MHz	3.5 m $\Omega$	4.1 m $\Omega$	LR R47
LPM0630LRR56ME	0.56 $\mu$ H, $\pm$ 20%	18.00 A	15.50 A	61 MHz	4.7 m $\Omega$	5.0 m $\Omega$	LR R56
LPM0630LRR68ME	0.68 $\mu$ H, $\pm$ 20%	17.00 A	14.00 A	68 MHz	6.0 m $\Omega$	6.5 m $\Omega$	LR R68
LPM0630LRR82ME	0.82 $\mu$ H, $\pm$ 20%	16.00 A	12.50 A	49 MHz	7.0 m $\Omega$	7.5 m $\Omega$	LR R82
LPM0630LR1R0ME	1.00 $\mu$ H, $\pm$ 20%	15.00 A	12.00 A	52 MHz	8.5 m $\Omega$	9.0 m $\Omega$	LR 1R0
LPM0630LR1R5ME	1.50 $\mu$ H, $\pm$ 20%	14.00 A	10.00 A	30 MHz	10.5 m $\Omega$	12.0 m $\Omega$	LR 1R5
LPM0630LR2R2ME	2.20 $\mu$ H, $\pm$ 20%	10.00 A	8.00 A	30 MHz	16.0 m $\Omega$	18.5 m $\Omega$	LR 2R2
LPM0630LR3R3ME	3.30 $\mu$ H, $\pm$ 20%	10.00 A	6.50 A	24 MHz	25.0 m $\Omega$	28.0 m $\Omega$	LR 3R3
LPM0630LR4R7ME	4.70 $\mu$ H, $\pm$ 20%	6.50 A	5.50 A	19 MHz	32.5 m $\Omega$	35.0 m $\Omega$	LR 4R7
LPM0630LR5R6ME	5.60 $\mu$ H, $\pm$ 20%	5.00 A	6.00 A	17 MHz	32.5 m $\Omega$	35.5 m $\Omega$	LR 5R6
LPM0630LR6R8ME	6.80 $\mu$ H, $\pm$ 20%	6.00 A	4.50 A	16 MHz	54.0 m $\Omega$	60.0 m $\Omega$	LR 6R8
LPM0630LR100ME	10.00 $\mu$ H, $\pm$ 20%	5.50 A	4.00 A	13 MHz	62.0 m $\Omega$	68.0 m $\Omega$	LR 100
LPM0630LR150ME	15.00 $\mu$ H, $\pm$ 20%	5.00 A	3.00 A	12 MHz	110.0 m $\Omega$	120.0 m $\Omega$	LR 150
LPM0630LR220ME	22.00 $\mu$ H, $\pm$ 20%	2.50 A	2.50 A	8 MHz	152.0 m $\Omega$	167.0 m $\Omega$	LR 220
LPM0630HI1R0ME	1.00 $\mu$ H, $\pm$ 20%	20.50 A	11.00 A	40 MHz	9.0 m $\Omega$	10.00m $\Omega$	1R0
LPM0630HI1R5ME	1.50 $\mu$ H, $\pm$ 20%	17.00 A	9.00 A	35 MHz	14.0 m $\Omega$	15.0 m $\Omega$	1R5
LPM0630HI2R2ME	2.20 $\mu$ H, $\pm$ 20%	14.00 A	8.00 A	29 MHz	18.0 m $\Omega$	20.0 m $\Omega$	2R2
LPM0630HI3R3ME	3.30 $\mu$ H, $\pm$ 20%	13.50 A	6.80 A	22 MHz	28.0 m $\Omega$	30.0 m $\Omega$	3R3
LPM0630HI4R7ME	4.70 $\mu$ H, $\pm$ 20%	10.00 A	5.50 A	17 MHz	37.0 m $\Omega$	40.0 m $\Omega$	4R7
LPM0630HI6R8ME	6.80 $\mu$ H, $\pm$ 20%	8.00 A	4.50 A	15 MHz	54.0 m $\Omega$	60.0 m $\Omega$	6R8
LPM0630HI8R2ME	8.20 $\mu$ H, $\pm$ 20%	7.50 A	4.00 A	16 MHz	64.0 m $\Omega$	68.0 m $\Omega$	8R2
LPM0630HI100ME	10.00 $\mu$ H, $\pm$ 20%	7.00 A	3.00 A	14 MHz	102.0 m $\Omega$	105.0 m $\Omega$	100

\*1. I<sub>dc1</sub>: Based on inductance change  
 $\Delta$ L/Lo: -30% for LR       $\Delta$ L/Lo: -20% for HI  
 \*2. I<sub>dc2</sub>: Based on temperature rise ( $\Delta$ T: 40°C TYP.)

Notes: Inductance is measured in HP-4285A Precision LCR Meter under 100KHz, 0.25V  
 RDC measured in HP 4338B milliohm meter (or equivalent).

# POWER INDUCTORS, SHIELDED

## LPM SERIES

### ENVIRONMENTAL PERFORMANCE

	SPECIFICATION	TEST PARAMETERS
VIBRATION	$\Delta L/L_0 : \leq \pm 5\%$ There shall be no mechanical damage	Solder specimen inductor on the test printed circuit board. Apply vibrations in each of the x, y and z directions for 2 hours for a total of 6 hours. Frequency : 10~55~10Hz in 60sec as a period    Amplitude : 1.5mm
SOLDERABILITY	The metalized area must have 90% minimum solder coverage.	Preheating at 160±10°C 90sec. 245°C ±5°C for 2 ±1sec.
HIGH TEMPERATURE STORAGE	$\Delta L/L_0 : \leq \pm 5\%$ There shall be no mechanical damage or electrical damage.	The sample shall be left for 96 hours in an atmosphere with a temperature of 85±2°C and a normal humidity. Upon completion of the test, the measurement shall be made after the sample has been left in a normal temperature and normal humidity for 1 hour.
LOW TEMPERATURE STORAGE	$\Delta L/L_0 : \leq \pm 5\%$ There shall be no mechanical damage or electrical damage.	The sample shall be left for 96 hours in an atmosphere with a temperature of -40±2°C. Upon completion of the test, the measurement shall be made after the sample has been left in a normal temperature and normal humidity for 1 hour.
MOISTURE STORAGE	$\Delta L/L_0 : \leq \pm 5\%$ There shall be no mechanical damage	The sample shall be left for 96 hours in a temperature of 40±2°C and a humidity(RH) of 90~95%. Upon completion of the test, the measurement shall be made after the sample has been left in a normal temperature and normal humidity more than 1 hour.
SUBSTRATE BENDING	$\Delta L/L_0 : \leq \pm 5\%$ There shall be no mechanical damage or electrical damage	The sample shall be soldered onto the printed circuit board and a load applied until the figure in the arrow direction is made approximately 2mm (keep time 5 ±1 seconds).
THERMAL SHOCK	$\Delta L/L_0 : \leq \pm 5\%$ There shall be no damage or problems.	The sample shall be subject to 10 continuous cycles, such as shown in the following temperature cycle. Measure the test items after leaving the inductors at room temperature and humidity for 1 hour.

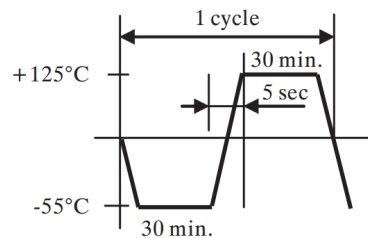
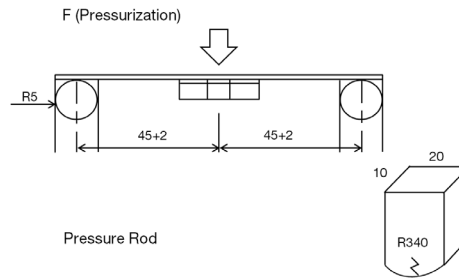

# POWER INDUCTORS, SHIELDED LPM SERIES

## SOLDERING INFORMATION

RECOMMENDED FOOTPRINT:

Dimensions	Units	SIZE CODES		
		0520	0530	0630
A	In	0.236	0.236	0.331
	mm	5.990	5.990	8.400
B	In	0.098	0.098	0.134
	mm	2.500	2.500	3.400
C	In	0.087	0.087	0.146
	mm	2.200	2.200	3.700

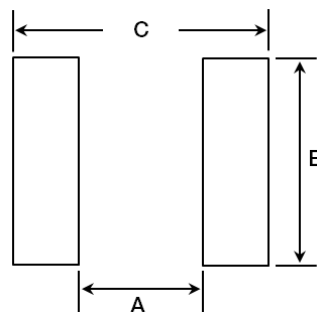

RECOMMENDED SOLDER ATTACHMENT: REFLOW SOLDERING

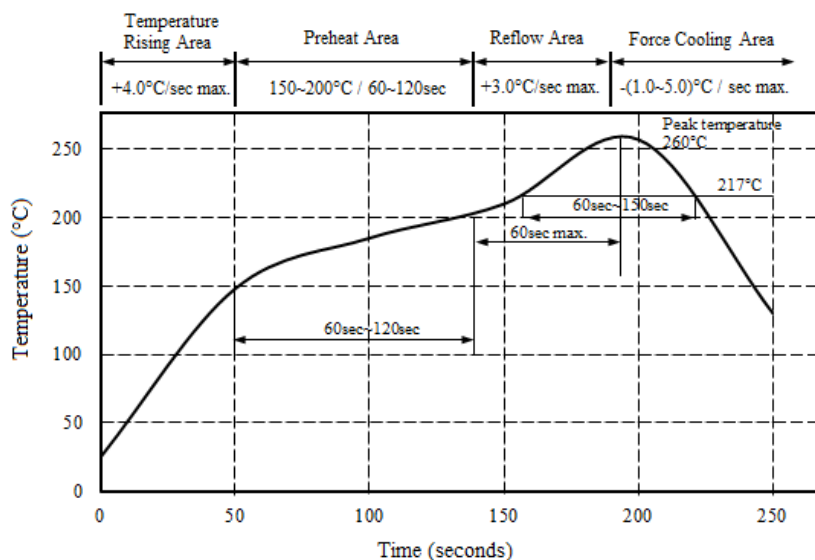

Peak Temperature: 260°C max  
 Max Peak Temperature: -5°C: 30sec max.  
 Max Time above 217°C: 60sec ~150 sec max.

If hand soldering must be used, follow these precautions:

- Use solder iron of less than 30W when soldering.
- Do not allow soldering iron tip to directly touch the ferrite body outside of the terminal electrode.
- 2 seconds maximum at 260°C.

\* This datasheet is subject to change without notice

# PLANAR CAPACITOR ARRAYS FOR EMI FILTERING

Johanson Dielectrics is the premier supplier of Planar Capacitor EMI Filter Arrays to the Filtered Connector Industry. Johanson filters exhibit excellent RF performance, as well as high SRF's (Series Resonant Frequency). Planar Capacitors are the fundamental building block for filtered connectors in Aerospace, Biomedical, Military, Satellite, Industrial and Communication electronics.

Johanson offers NP0, X7R and MOV (Metal Oxide Varistor) Planar Arrays in standard and custom solutions to fit your needs (1 to 150 pins).

MOV planar arrays can be used singularly to form low pass C filters with the additional benefit of transient voltage protection. When combined together with planar array capacitors, they can form balanced and unbalanced Pi filters with transient voltage protection. The MOV technology enables smaller connectors to be built when compared to other discrete voltage protection component solutions, such as diodes.

We are eager to quote your custom requirements and unique products, in addition to your commercial or Mil-Standard needs.

Each Johanson part is customized to meet specific customer needs.

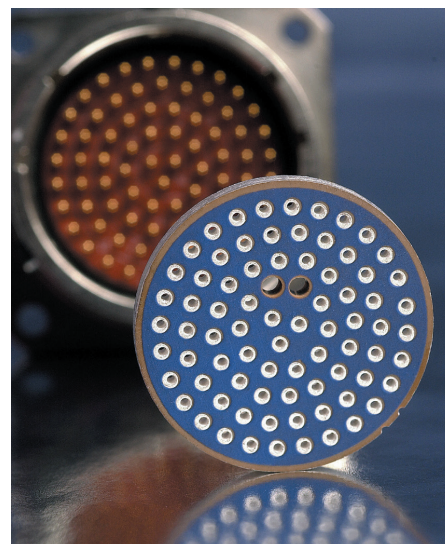

## CIRCULAR ARRAYS



EXAMPLE PHYSICAL LAYOUT	DIELECTRIC MATERIAL	AVAILABLE CAPACITANCE	WORKING VOLTAGE	DWV VOLTAGE
MIL-1560 MIL-1554 MIL-1669 MIL-1651 MIL-1698 MIL-33702 MIL-AUDIO	X7R, NP0 & Selected MOV	47 pF to 1000 nF	Up to 2,000 VDC	Up to 2,500V VDC

## RECTANGULAR ARRAYS (ARINC 404/600)

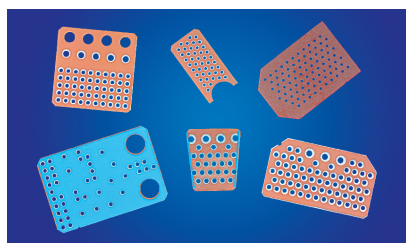

EXAMPLE PHYSICAL LAYOUT	DIELECTRIC MATERIAL	AVAILABLE CAPACITANCE	WORKING VOLTAGE	DWV VOLTAGE
AR-010 Through AR-150	X7R, NP0 & Selected MOV	47 pF to 1000 nF	Up to 2,000 VDC	Up to 2,500V VDC

## D-SUBMINATURE RECTANGULAR ARRAYS

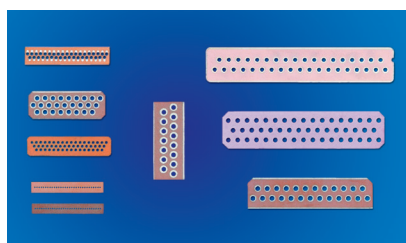

EXAMPLE PHYSICAL LAYOUT	DIELECTRIC MATERIAL	AVAILABLE CAPACITANCE	WORKING VOLTAGE	DWV VOLTAGE
Full Size	X7R, NP0 & Selected MOV	47pF - 210nF	≤ 2,400	≤ 3,600
Mini-D		47pF - 100nF	≤ 1,000	≤ 1,500
Micro-D		47pF - 22.5nF	≤ 680	≤ 1,020
Nano-D		47pF - 3.0nF	≤ 200	≤ 500
Combo-D		47pF - 6.0nF	≤ 800	≤ 1,200
Power-D		47pF - 120nF	≤ 680	≤ 1,020
Special		47pF - 50nF	≤ 300	≤ 750



# PLANAR CAPACITOR ARRAYS FOR EMI FILTERING

## CUSTOM ARRAYS

Johanson Dielectrics's design expertise and CNC manufacturing process enable broad custom array capability. Many shapes, configurations and geometries are possible. Share your requirements and we will create a solution!

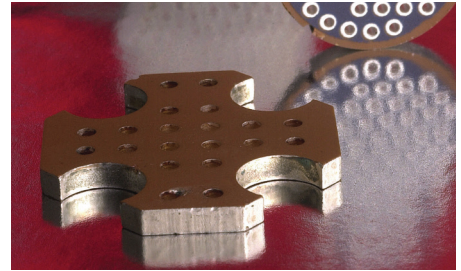

## DISCOIDAL CAPACITORS

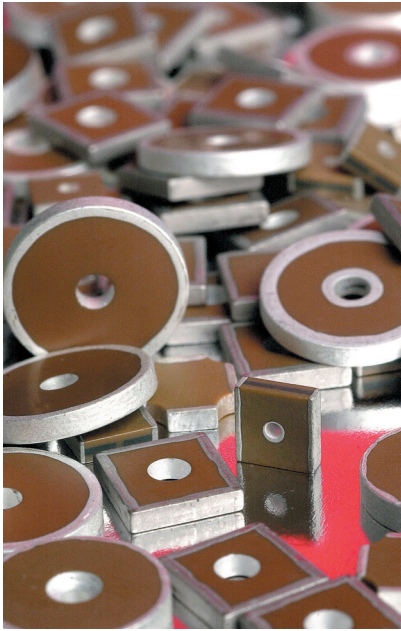

Johanson Discoidal Feed-through Capacitors are the functional element in widely used EMI feed-through filters. This capacitor configuration offers very low impedance and inductance. Discoidal capacitors are ideal for by-pass, filtering, coupling, single line EMI/RFI suppression, and high frequency applications.

- Capacitance values from 10 pF to 11.2  $\mu$ F
- Test standards and procedures per MIL-STD-202 and MIL-C-123
- Voltage ratings from 50 to 3000 VDC and 50 to 240 VAC
- Low ESR and ESL, non-polar designs

Call us to discuss your special requirements!

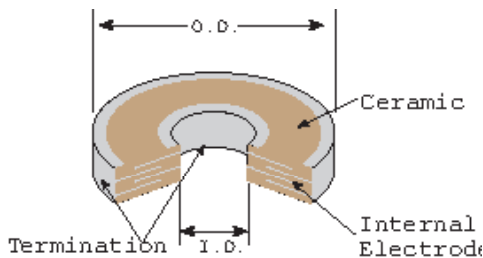

EXAMPLE NOMINAL O.D. (IN.)	DIELECTRIC MATERIAL	AVAILABLE CAPACITANCE	INSIDE DIAMETER (IN.)	THICKNESS (IN.)	RATED VOLTAGE
0.100 $\pm$ .005	X7R, NP0 & Selected MOV	10 pF – 66 nF	0.025 $\pm$ 0.048	0.025 $\pm$ 0.070	Up to 200 VDC
0.150 $\pm$ .005		10 pF – 200 nF	0.037 $\pm$ 0.058	0.025 $\pm$ 0.070	Up to 200 VDC
0.335 $\pm$ .005		10 pF – 2.8 $\mu$ F	0.034 $\pm$ 0.088	0.040 $\pm$ 0.110	Up to 500 VDC
0.345 $\pm$ .005		10 pF – 6.0 $\mu$ F	0.040 $\pm$ 0.085	0.055 $\pm$ 0.110	Up to 750 VDC
0.376 $\pm$ .005		10 pF – 8.0 $\mu$ F	0.050 $\pm$ 0.075	0.065 $\pm$ 0.125	Up to 750 VDC
0.643 $\pm$ .005		10 pF – 15 $\mu$ F	0.063 $\pm$ 0.080	0.055 $\pm$ 0.150	Up to 750 VDC
0.840 $\pm$ .005		10 pF – 20 $\mu$ F	0.050 $\pm$ 0.075	0.080 $\pm$ 0.130	Up to 1000 VDC

# CAPSTRATE® CAPACITOR SUBSTRATES

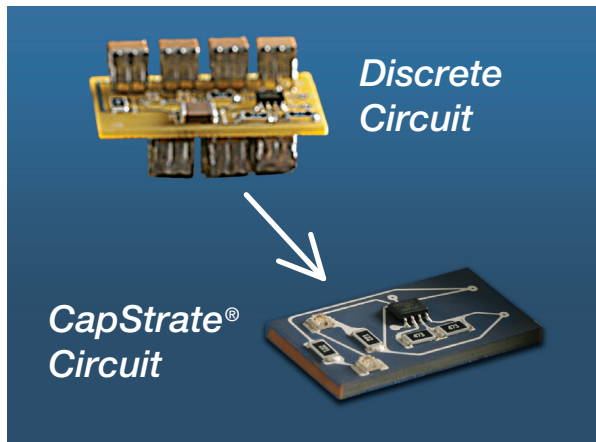

Johanson CapStrate® products integrate bulk capacitance into a ceramic substrate eliminating large discrete capacitive components which saves critical space and simplifies the assembly process. Our design and manufacturing expertise in large format, custom geometries provides innovative solutions that economically solve a wide variety of your design challenges.

## ADVANTAGES

- Major Size & Weight Reduction
- Fewer Solder Joints
- Lower Assembly Cost
- Circuit Assembly Available

## KEY FEATURES

- Integrated Capacitance in The Substrate
- Rated Working Voltages from 50V to 5,000V
- Temperature ranges: -55°C to 125°C (specials to 200°C and 250°C)
- Compact Designs Utilizing Military Grade Ceramics
- Custom Sizes, Values, and Voltages Available

## SIZE / CAPACITANCE CAPABILITY EXAMPLES

SUBSTRATE SIZE		LENGTH	WIDTH	THICK	NP0 50V	NP0 100V	NP0 200V	NP0 500V	X7R 50V	X7R 100V	X7R 200V	X7R 500V
CapStrate 4	In	0.400	0.400	0.120	0.22µF	0.15µF	0.12µF	0.07µF	9.0µF	6.0µF	3.0µF	1.5µF
	mm	10.2	10.2	3.1								
CapStrate 3	In	0.450	1.00	0.120	0.70µF	0.50µF	0.39µF	0.22µF	28.0µF	20.0µF	9.0µF	4.7µF
	mm	11.43	25.4	3.1								
CapStrate 1	In	0.450	2.00	0.120	1.40µF	1.00µF	0.75µF	0.44µF	50.0µF	40.0µF	18.0µF	9.4µF
	mm	11.4	50.8	3.1								
CapStrate 2	In	0.800	1.50	0.120	2.00µF	1.40µF	1.00µF	0.60µF	75.0µF	55.0µF	25.0µF	14.0µF
	mm	20.3	38.1	3.1								
CapStrate 6	In	1.250	2.00	0.120	4.00µF	2.80µF	2.00µF	1.20µF	150.0µF	110.0µF	50.0µF	28.0µF
	mm	31.8	50.8	3.1								
Circular CapStrate® Capacitance Formula					1.3 -1.6 µF / In <sup>2</sup>	0.9 -1.1 µF / In <sup>2</sup>	0.7 -0.8 µF / In <sup>2</sup>	50 - 62 µF / In <sup>2</sup>	35 - 45 µF / In <sup>2</sup>	18 - 20 µF / In <sup>2</sup>	1.3 -1.6 µF / In <sup>2</sup>	9 -10 µF / In <sup>2</sup>

This chart is intended to provide capability examples. Not all possibilities are shown and we invite application specific inquiries. Circular CapStrate® example lists available capacitance per area.



# CUSTOM CAPACITOR SOLUTIONS

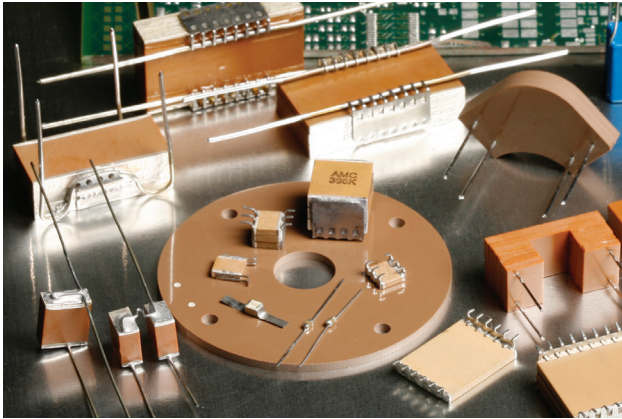

Johanson's extensive experience in design and manufacture of large format, custom geometries allows us to develop unique and innovative solutions which successfully solve a wide variety of our customer's design challenges. We'll work pro actively with you to fully understand your requirements and recommend the best solution possible.

## KEY FEATURES

---

- Custom shapes to fit specific requirements
- Multiple capacitors in a single assembly
- NP0/COG and X7R solutions from -55°C to +125°C
- Multiple pin, lead-frame, and flying wire options
- Bare ceramic, epoxy coated, potted solutions

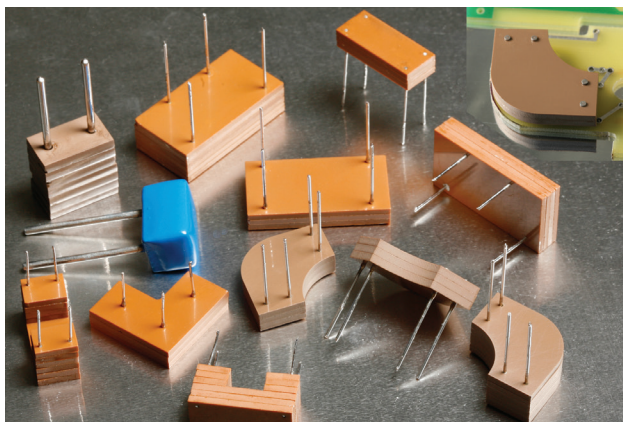
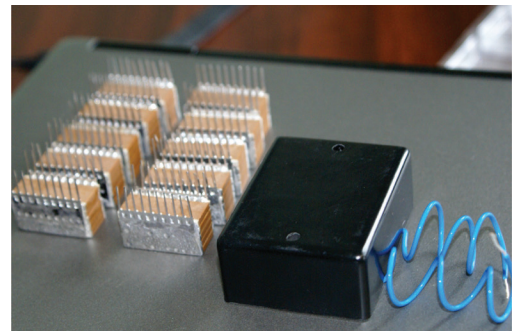

## VARIABLE PITCH ASSEMBLIES

---

Another custom approach is our variable pitch design. No longer are you limited to a vendor's standard catalogue offering or only square or rectangular custom designs. We let you become your own capacitor designer by not only telling us the desired capacitance and voltage, but also the size, shape, and location of leads! This process helps insure that the resulting capacitor satisfies every aspect of your design requirements.

## ON-LINE PRODUCTS

---

200°C Radial Leaded Capacitors  
Large Size MLC Capacitors  
High Power AC Capacitors



# CAPACITOR GENERAL ELECTRICAL CHARACTERISTICS & PN BREAKDOWN

## ELECTRICAL CHARACTERISTICS

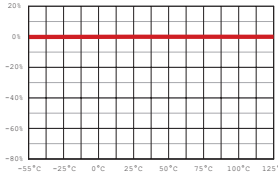
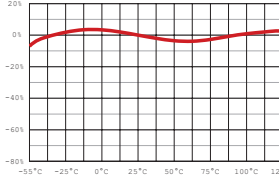
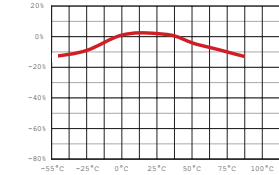
PARAMETER	NP0		X7R		X5R	
TEMPERATURE COEFFICIENT:	0 ± 30 ppm/°C	-55 to +125°C	± 15%	-55 to +125°C	± 15%	-55 to +85°C
						
DISSIPATION FACTOR:	.001 (0.1%) max		WVDC ≥ 50 VDC, DF = 2.5% max WVDC = 25 VDC, DF = 3.0% max WVDC = 16 VDC, DF = 3.5% max		For Vrated ≥ 50 VDC, DF = 5% max For Vrated ≤ 25 VDC: DF = 10% max	
AGING:	None		2.5% / decade hour		2.5 % / decade hour	
INSULATION RESISTANCE:	1000ΩF or 100GΩ whichever is less @ 25°C, WVDC		500ΩF or 50GΩ whichever is less @ 25°C, WVDC		100ΩF or 10GΩ whichever is less @ 25°C, WVDC	
DIELECTRIC STRENGTH:	For Vrated = 6 - 200 VDC, DWV = 2.5 X WVDC, 25°C, 50mA max. For Vrated = 201 - 499 VDC, DWV = 2.0 X WVDC, 25°C, 50mA max. For Vrated = 500 - 999 VDC, DWV = 1.5 X WVDC, 25°C, 50mA max. For Vrated = 1000+ VDC, DWV = 1.2 X WVDC, 25°C, 50mA max.				DWV = 2.5 X WVDC, 25°C, 50mA max.	
TEST PARAMETERS:	C > 100 pF; 1kHz ±50Hz; 1.0±0.2 VRMS C ≤ 100 pF 1Mhz ±50kHz; 1.0±0.2 VRMS		Capacitance values ≤ 10 μF: 1.0kHz±50Hz @ 1.0±0.2 Vrms  Capacitance values > 10 μF: 120Hz±10Hz @ 0.5V±0.1 Vrms		Capacitance values ≤ 10 μF: 1.0kHz±50Hz @ 1.0±0.2 Vrms  Capacitance values > 10 μF: 120Hz±10Hz @ 0.5V±0.1 Vrms	
NOTES:	Tanceram IR = 100 ΩF or 10 GΩ Tanceram DF for Vrated ≥ 50 VDC = 5% max. Tanceram DF for Vrated ≤ 25 VDC, DF = 10% max					

## PART NUMBER BREAKDOWN - SURFACE MOUNT

Part number written: 502R29W102KV3E-\*\*\*\*-SC

502	R 29	W	102	K	V	3	E
VOLTAGE	SERIES/SIZE	DIELECTRIC	CAPACITANCE	TOLERANCE	TERMINATION	MARKING	PACKING
6R3 = 6.3 V DC 100 = 10 V DC 160 = 16 V DC 250 = 25 V DC 500 = 50 V DC 101 = 100 V DC 201 = 200 V DC 251 = 250 V DC 301 = 300 V DC 501 = 500 V DC 631 = 630 V DC 102 = 1000 V DC 202 = 2000 V DC 302 = 3000 V DC* 402 = 4000 V DC 502 = 5000 V DC* ACJ = 250 VAC	A__ = ARRAY B__ = LICC F__ = F-T FILTER R__ = MLCC S__ = MLCC T__ = HI TEMP MLCC X__ = X2Y  _05=0201 _07=0402 _14=0603 _15=0805 _18=1206 _41=1210 _29=1808 _30=2211 _43=1812 _44=1410 _47=2220 _49=1825 _48=2225	N = NP0 W = X7R X = X5R	1st two digits are significant; third digit denotes number of zeros, R = decimal.  5R6 = 5.6 pF 100 = 10 pF 102 = 1,000 pF 474 = 0.47 μF 475 = 4.7 μF 106 = 10 μF	* B = ± 0.10 pF * C = ± 0.25 pF * D = ± 0.50 pF F = ± 1 % G = ± 2 % J = ± 5 % K = ± 10 % M = ± 20 % Y = +50 -20 % Z = +80 -20 %  *Values < 10 pF only	V = Nickel Barrier with 100% Tin Plating (Matte)  F = Polyterm flexible termination G = Gold T = SnPb P = PdAg	3 = Special 4 = Unmarked 6 = EIA Code*  *Not available on sizes ≤ 0402	E = Embossed 7" T = Punched 7" U = Embossed 13" R = Punched 13"  No code = bulk pack  Tape specifications conform to EIA RS481  Not all tape styles are available on all parts.
<div style="text-align: center;"> <span style="border: 1px solid black; padding: 2px;">-****-</span> <span style="border: 1px solid black; padding: 2px;">SC</span> </div> <p style="text-align: center;"><b>PART NUMBER MODIFIER</b></p> <p style="text-align: center;">Used on select parts such as Safety Certified or for customer specific requirements.</p>							
<p>* For Safety Caps with -****-SC P/N suffix only: 302 = 250VAC [2500V Impulse] 502 = 250VAC [5000V Impulse]</p>							

**PLEASE NOTE:** Not all combinations of JDI P/Ns are valid. Please refer to the "How to Order" detail section of the specific product or contact your Sales Representative if you need assistance.



# CAPACITOR PACKAGING

Johanson capacitors are available taped per EIA standard 481. Tape options include 7" and 13" diameter reels. Johanson uses high quality, dust free, punched 8mm paper tape and plastic embossed 8mm tape for thicker MLCCs. Quantity per reel ranges are listed in the tables below and are dependent on chip thickness.

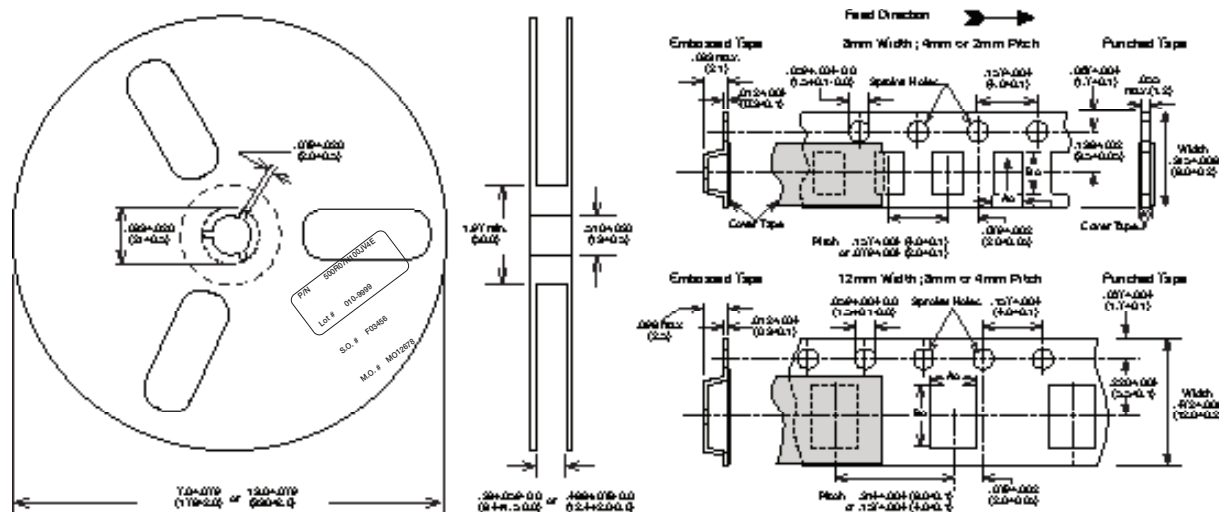

COMPONENT	7" DIAMETER REEL				13" DIAMETER REEL			
	REEL QTY	TAPE TYPE	WIDTH / PITCH	CODE	REEL QTY	TAPE TYPE	WIDTH / PITCH	CODE
R05 / 0201 MLCC	15000	Paper	8mm/2mm	T	N/A	N/A		N/A
R07 / 0402 MLCC	10000	Paper	8mm/2mm	T	N/A	N/A		N/A
R14 / 0603 MLCC	4000	Paper	8mm/4mm	T	10000	Paper	8mm/4mm	R
R15 / 0805 MLCC	4000 / 3000	Paper / Embossed	8mm/4mm	T / E	10000	Paper / Embossed	8mm/4mm	R / U
R18 / 1206 MLCC	4000 / 3000	Paper / Embossed	8mm/4mm	T / E	10000	Paper / Embossed	8mm/4mm	R / U
S41 / 1210 MLCC	2000 - 4000	Embossed	8mm/4mm	E	5000-10000	Embossed	8mm/4mm	U
R29 / 1808 MLCC	2000	Embossed	12mm/4mm	E	5000 - 8000	Embossed	12mm/4mm	U
R30 / 2211 MLCC	1000 - 2000	Embossed	12mm/4mm	E	2000 - 5000	Embossed	12mm/4mm	U
S43 / 1812 MLCC	500 - 1000	Embossed	12mm/8mm	E	3000 - 5000	Embossed	12mm/8mm	U
S47 / 2220 MLCC	250 - 1000	Embossed	12mm/8mm	E	2000 - 5000	Embossed	12mm/8mm	U
S49 / 1825 MLCC	250 - 1000	Embossed	12mm/8mm	E	2000 - 4000	Embossed	12mm/8mm	U
S48 / 2225 MLCC	250 - 1000	Embossed	12mm/8mm	E	2000 - 4000	Embossed	12mm/8mm	U
X07 / 0402 X2Y	4000	Paper	8mm/2mm	T	10000	Paper	8mm/2mm	R
X14 / 0603 X2Y	4000	Paper	8mm/4mm	T	10000	Paper	8mm/4mm	R
X15 / 0805 X2Y	4000	Embossed	8mm/4mm	E	10000	Embossed	8mm/4mm	U
X18 / 1206 X2Y	3000 - 4000	Embossed	8mm/4mm	E	10000	Embossed	8mm/4mm	U
X41 / 1210 X2Y	2000 - 3000	Embossed	8mm/4mm	E				
X44 / 1410 X2Y	1000 - 2000	Embossed	8mm/4mm	E				
X43 / 1812 X2Y	1000	Embossed	12mm/8mm	E				

Actual reel quantities based on part thickness and tape type. Contact sales for reel quantities of specific part numbers.



# INDEX OF APPLICATION NOTES AVAILABLE AT JOHANSONDIELECTRICS.COM

## *GENERAL*

---

Ceramic Capacitor aging made simple  
Capacitor Cracks: Still with us after all these years  
Understanding Ceramic Capacitors termination  
Capacitors Packaging & Marking  
Electrical Characteristics  
MLCC Storage and Handling Conditions

## *APPLICATION NOTES*

---

AC Power Computations for DC Rated Capacitor  
Arc Season and Board Design Observations  
Corona Effects and their impact on PWB Layout induced Hipot failures  
DC-DC Converter trends and Output Filter Capacitors  
Impact of pad design and spacing on AC breakdown performance  
Pb Free Application Notes  
Polyterm® Flexible SMD Termination  
Safety Certified Application Notes  
Sn/Pb SMT Application Notes  
Soldering and Handling precautions for Large Form Capacitors and Planar Arrays  
Tantalum replacement MLC's and ESR Curves

## *PROCESSING*

---

Foward/Backward process compatability  
Pb Free Application Notes  
Peak Reflow times, temperature and the impact of MSL  
Tin Wisker testing

## *X2Y APPLICATION NOTES*

---

Amplifier Decoupling: EMI vs MLCC  
GSM RFI Supression with EMI Filters  
EMI Filter Evaluation and PCB design guide  
Improve instrument amplifier performance with X2Y optimized input filter  
EMI DC motor filtering basics  
EMI power bypass mounting  
EMI SerDes bypass example



# Your Technology Partner

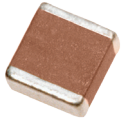

High Voltage

High Capacitance



EMI Filters

AC Safety



High Temperature

AC Power

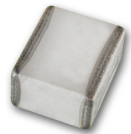

Precision Power Resistors

Power Inductors

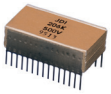

SMPS & Leaded

Planar Arrays & Discodials



Custom Solutions

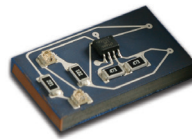

UNITED STATES:  
HEADQUARTERS  
4001 Calle Tecate,  
Camarillo CA 93012  
TEL (805) 389-1166  
<https://www.johansondielectrics.com>

HONG KONG:  
JOHANSON HONG KONG, LTD.  
Unit 812, Heng Ngai Jewelry Ctr.,  
44 Hok Yuen Street East, Hunghom,  
Kowloon, Hong Kong  
TEL +852 2334 6310  
[asiasales@johansondielectrics.com](mailto:asiasales@johansondielectrics.com)

## X-ON Electronics

Largest Supplier of Electrical and Electronic Components

*Click to view similar products for [Safety Capacitors](#) category:*

*Click to view products by [Johanson](#) manufacturer:*

Other Similar products are found below :

[R49AN347000A1K](#) [B32022B3223K026](#) [B32912A3104K026](#) [46KI3470DQM1K](#) [B32913A3154K](#) [MKPY2-.02230020P15](#) [46KN333000M1M](#)  
[DE1E3KX222MJ4BN01F](#) [46KR422000M1K](#) [B32924C3824K189](#) [46KI3100DQM1M](#) [HUB2200-S](#) [BFC2 33910103](#) [46KN3330JBM1K](#)  
[463I333000M1K](#) [46KF2470JBN0M](#) [46KF268000M1M](#) [46KI22205001M](#) [46KI24705201K](#) [46KI2470CK01M](#) [46KI2470ND01K](#)  
[46KI2680JH01M](#) [46KI315000M2K](#) [46KI3150CKM2K](#) [46KI3150CKM2M](#) [46KI3150NDM2M](#) [46KI3220JLM1M](#) [46KN3150JH01K](#)  
[46KN34705001K](#) [46KN347050N0K](#) [46KN3470JHP0M](#) [46KN410040H1M](#) [46KN415000P1M](#) [46KW510050M1K](#) [474I24700003K](#)  
[PHE840MD6220MD13R30](#) [PHE840MY6470MD14R06](#) [PHE845VD5470MR06](#) [R463N4100ZAM1K](#) [46KR410050M1K](#)  
[YV500103Z060B20X5P](#) [MKPX2R-1/400/10P27](#) [YU0AH222M090DAMD0B](#) [LS1808N102K302NX080TM](#) [R463F210000N0K](#)  
[R463I26800001K](#) [R463I315000M2K](#) [F861AO224K310A](#) [F861KJ223K310A](#) [DE21XSA470KA3BT02F](#)