

# "High Frequency Ceramic Solutions"

5.4GHz Miniature EIA 0202 (0.65x0.50mm) High Pass Filter for WiFi, IoT Applications

P/N 5400HP05A0950

Detail Specification: 7/9/2018

Page 1 of 3

Not exactly what you are looking for and want to see our other filters? Go to: [www.johansontechnology.com/integrated-passives](http://www.johansontechnology.com/integrated-passives)

General Specifications	
Part Number	5400HP05A0950
Frequency Range	4900 - 6000 MHz
Operating Temp. Range	-40 to +105 °C
Recommended Storage Conditions for uninstalled product still on T&R	+5 to +35 °C, Humidity 45~75%RH 18 months max.
Qty/Reel (pcs)	10,000

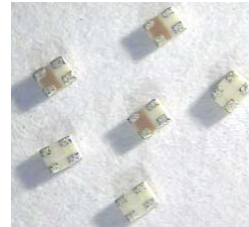

Electrical Specifications		
Operating Temp	-40C to +85°C	+85C to +105°C
Insertion Loss @ BW (dB)	0.55 typ. (0.65 dB max.)	0.73 typ. (0.75 dB max.)
Attenuation (dB)	20 dB min (@2450-2500MHz)	20 dB min (@2450-2500MHz)
VSWR @ BW	2.0 max.	2.0 max.
Power Capacity	2W max. (CW)	2W max. (CW)

Terminal Configuration			
<Top View>			
1	IN/OUT	3	GND
2	IN/OUT	4	GND

Part Number Explanation				
P/N Suffix	Packing Style	Bulk	Suffix = S	eg. 5400HP05A0950S
		T & R	Suffix = T	eg. 5400HP05A0950T
	Termination style	100% Tin	Suffix = None	eg. 5400HP05A0950(T or S)
Evaluation Board		5400HP05A0950-EB1SMA		

### Mounting Considerations

- Solder Resist
- Land
- Through-hole ( $\phi 0.35$ )

\* Line width should be designed to match 50 $\Omega$  characteristic impedance, depending on PCB material and thickness.

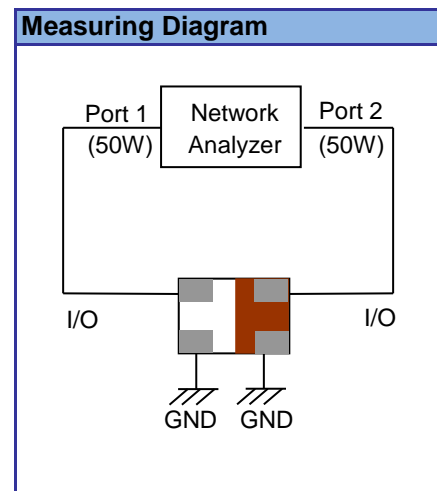

# "High Frequency Ceramic Solutions"

5.4GHz Miniature EIA 0202 (0.65x0.50mm) High Pass Filter for WiFi, IoT Applications

P/N 5400HP05A0950

Detail Specification: 7/9/2018

Page 2 of 3

## Mechanical Specifications

	In	mm
L	0.026 ± 0.002	0.65 ± 0.05
W	0.020 ± 0.002	0.50 ± 0.05
T	0.015 max.	0.37 max.
a	0.009 +0.004/-0.002	0.225 +0.1/-0.05
b	0.008 +0.004/-0.002	0.200 +0.1/-0.05
c	0.006 +0.004/-0.002	0.150 +0.1/-0.05
d	0.008 +0.004/-0.002	0.200 +0.1/-0.05

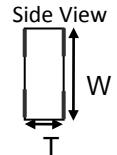
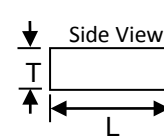
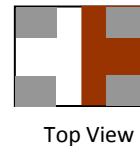
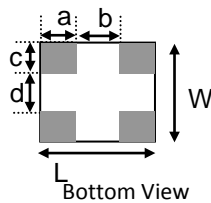

## Typical Electrical Characteristics (T=25 °C)

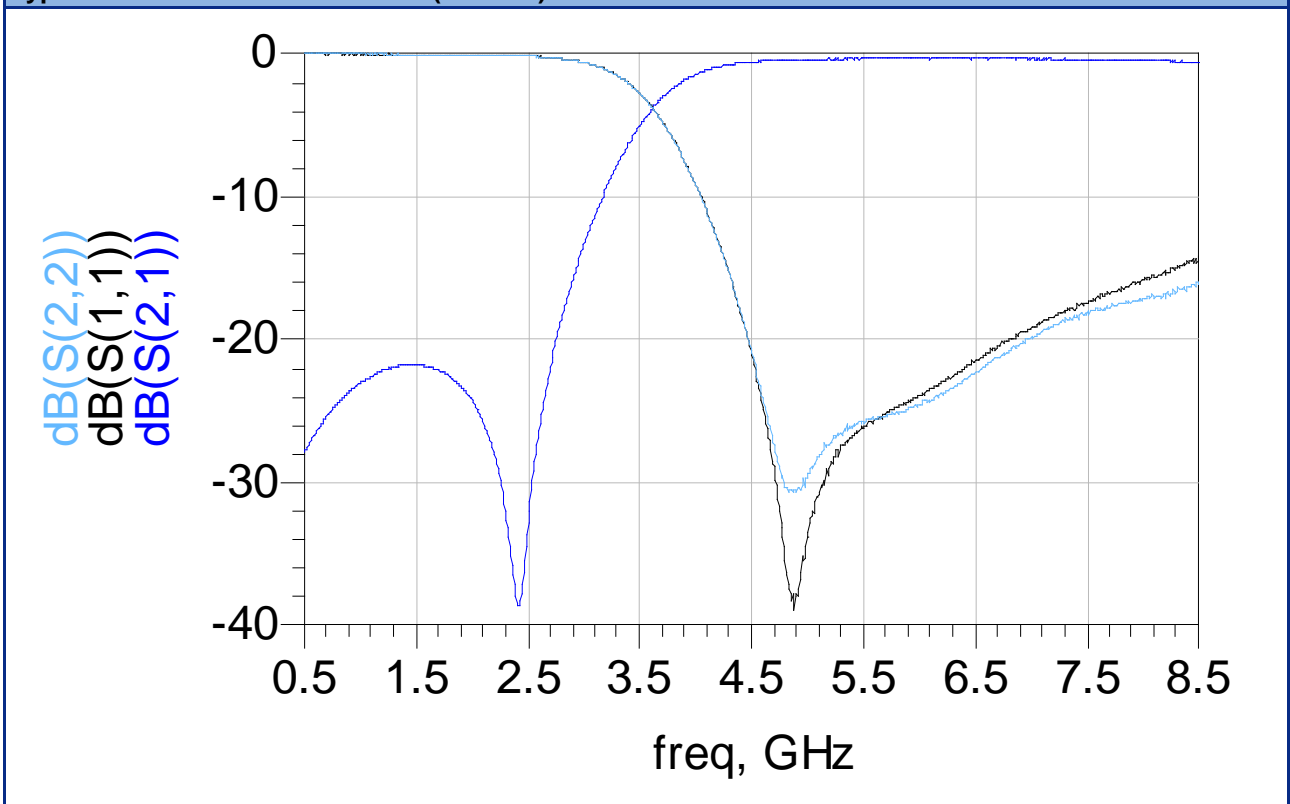

The contents of this data sheet are subject to change without notice. Please confirm the specifications and delivery conditions when placing your order. All sales are subject to Johanson Technology, Inc. terms and conditions.

# "High Frequency Ceramic Solutions"

5.4GHz Miniature EIA 0202 (0.65x0.50mm) High Pass Filter for  
WiFi, IoT Applications

P/N 5400HP05A0950

Detail Specification: 7/9/2018

Page 3 of 3

## RoHS Compliance

[www.johansontechnology.com/rohs-compliance](http://www.johansontechnology.com/rohs-compliance)

## Packaging information (T&R info, etc.)

[www.johansontechnology.com/tape-reel-packaging](http://www.johansontechnology.com/tape-reel-packaging)

## Soldering Information

[www.johansontechnology.com/ipcsoldering-profile](http://www.johansontechnology.com/ipcsoldering-profile)

## Layout Files, s-parameters and any other technical questions

[www.johansontechnology.com/ask-a-question](http://www.johansontechnology.com/ask-a-question)

## MSL Info

[www.johansontechnology.com/msl-rating](http://www.johansontechnology.com/msl-rating)

## Recommended Storage Condition and Max Shelf Life

[www.johansontechnology.com/recommended-storage-conditions](http://www.johansontechnology.com/recommended-storage-conditions)

## Need a small SMD chip Antenna?

[www.johansontechnology.com/antennas](http://www.johansontechnology.com/antennas)

## Antenna layout and tuning techniques

[www.johansontechnology.com/tuning](http://www.johansontechnology.com/tuning)

## Antenna layout review, tuning, and characterization services

[www.johansontechnology.com/ipc-antenna-services](http://www.johansontechnology.com/ipc-antenna-services)

The contents of this data sheet are subject to change without notice. Please confirm the specifications and delivery conditions when placing your order. All sales are subject to Johanson Technology, Inc. terms and conditions.



Ver 2.2

[www.johansontechnology.com](http://www.johansontechnology.com)

4001 Calle Tecate • Camarillo, CA 93012 • TEL 805.389.1166 FAX 805.389.1821

2018 Johanson Technology, Inc. All Rights Reserved

## X-ON Electronics

Largest Supplier of Electrical and Electronic Components

*Click to view similar products for [Signal Conditioning](#) category:*

*Click to view products by [Johanson](#) manufacturer:*

Other Similar products are found below :

[MAPDCC0001](#) [MAPDCC0004](#) [PD0409J5050S2HF](#) [880157](#) [HHS-109-PIN](#) [DC1417J5005AHF](#) [AFS14A30-2185.00-T3](#) [AFS14A35-1591.50-T3](#) [DS-323-PIN](#) [B39321R801H210](#) [1A0220-3](#) [JP510S](#) [LFB212G45SG8C341](#) [LFB322G45SN1A504](#) [LFL182G45TC3B746](#) [SF2159E](#) [30057](#)  
[FM-104-PIN](#) [CER0813B](#) [MAPDCC0005](#) [3A325](#) [40287](#) [41180](#) [ATB3225-75032NCT](#) [BD0810N50100AHF](#) [BD2425J50200AHF](#)  
[C5060J5003AHF](#) [JHS-115-PIN](#) [JP503AS](#) [DC0710J5005AHF](#) [DC2327J5005AHF](#) [DC3338J5005AHF](#) [43020](#) [LFB2H2G60BB1C106](#)  
[LFL15869MTC1B787](#) [X3C19F1-20S](#) [XC3500P-20S](#) [10013-20](#) [SF2194E](#) [CDBLB455KCAX39-B0](#) [TGL2208-SM, EVAL](#) [RF1353C](#)  
[PD0922J5050D2HF](#) [1E1305-3](#) [1F1304-3S](#) [1G1304-30](#) [B0922J7575AHF](#) [2020-6622-20](#) [TP-103-PIN](#) [BD1222J50200AHF](#)