

SPECIFICATIONS

Current Rating: 1A AC,DC
 Voltage Rating: 50V AC,DC
 Temperature Range: -25°C ~ +85°C
 Contact Resistance: 20mΩ Max.
 Insulation Resistance: 100MΩ Min.
 Withstanding Voltage: 500V AC/minute
 Pin Material: Phosphor Bronze
 Solder Tabs: Brass
 Wafer: Nylon 6T&9T,UL94V-0
 Cap: Nylon 6T,UL94V-0
 Color: Black & Beige

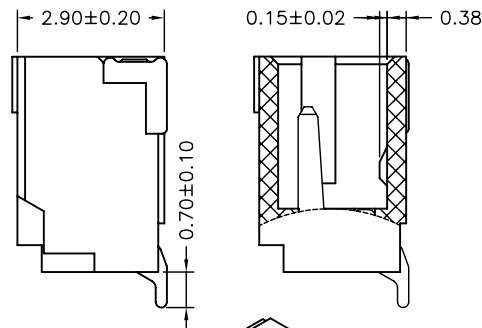

P/N LEGEND

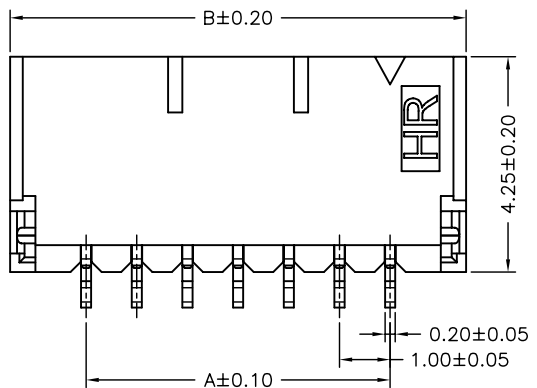

A1001 WR-S-XP XXX
 ① Series No.
 ② Connector type: WR=Wright angel
 ③ Mounting type: S=SMT without post
 ④ No. of circuits
 ⑤ Option code:
 Blank=Nylon 6T,UL94V-0,Color Natural(Beige)
 Contacts/Matte Tin-plated
 Solder tabs/Matte Tin-plated
 D01 =Nylon 6T,UL94V-0,Color Natural(Beige)
 Contacts/Gold-flash and
 Solder tabs/Gold-flash
 D02 =Nylon 6T,UL94V-0,Color Natural(Beige)
 Contacts/Gold-flash 3u" and
 Solder tabs/Gold-flash
 D11 =Nylon 6T,UL94V-0,Color Natural(Black)
 Contacts/Gold-flash and
 Solder tabs/Gold-flash
 D12 =Nylon9T,UL94V-0,Color Natural(Beige)
 Contacts/Gold-flash and
 Solder tabs/Gold-flash

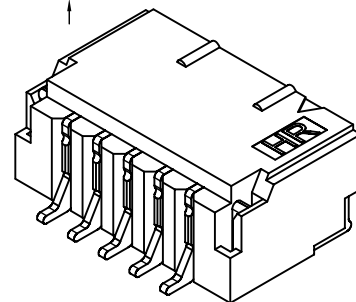
Circuit No.	Dimensions		
	A	B	C
02P	1.00	4.00	2.45
03P	2.00	5.00	3.45
04P	3.00	6.00	4.45
05P	4.00	7.00	5.45
06P	5.00	8.00	6.45
07P	6.00	9.00	7.45
08P	7.00	10.00	8.45
09P	8.00	11.00	9.45
10P	9.00	12.00	10.45
11P	10.00	13.00	11.45
12P	11.00	14.00	12.45
13P	12.00	15.00	13.45
14P	13.00	16.00	14.45
15P	14.00	17.00	15.45
16P	15.00	18.00	16.45
17P	16.00	19.00	17.45
18P	17.00	20.00	18.45
19P	18.00	21.00	19.45
20P	19.00	22.00	20.45
24P	23.00	26.00	23.45

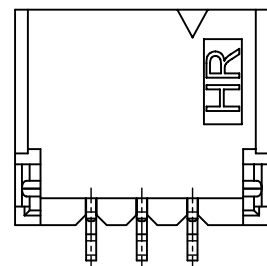
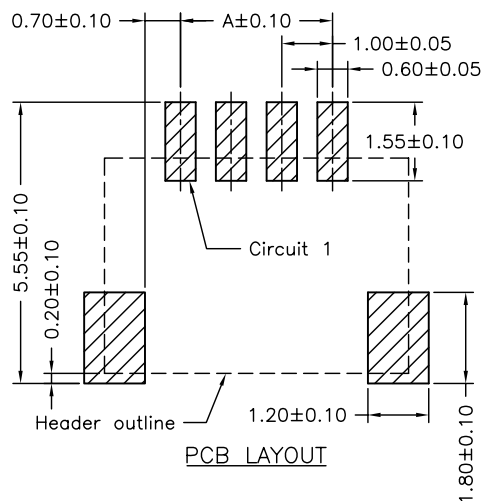

02~03P



						燦達電子工業股份有限公司 JOINT TECH ELECTRONIC IND. CO., LTD.	
		UNIT	SCALE	SHEET		TITLE:	
		mm		1 of 2		1.00mm PITCH 90° WAFER-SMT TYPE	
		DRAWN BY		APPROVED BY			
		蕭惠鳳 2002.05.28		董正一 2002.05.28			
		GENERAL TOLERANCE					
C0	EN1312160435	2013.12.18	郭本思	X.X±0.25	ANGLE± 		DRAW NO. : A1001WR-S-XP
B5	EN1110110449	2011.11.29	陳敏	X.XX±0.15			
REV.	DESCRIPTION	DATE	NAME	X.XXX±0.05			
							REV. CO

X-ON Electronics

Largest Supplier of Electrical and Electronic Components

Click to view similar products for [Headers & Wire Housings](#) category:

Click to view products by [Joint Tech](#) manufacturer:

Other Similar products are found below :

[57102-F02-18ULF](#) [58102-G61-06LF](#) [0009485154](#) [009176003701906](#) [0050291907](#) [02.125.8002.8](#) [609-3404](#) [61062-3](#) [622-0430](#) [622-3653LF](#)
[63453-116](#) [636-1030](#) [636-1427](#) [636-3427](#) [636-4007](#) [641938-9](#) [644827-2](#) [65495-038](#) [65692-001LF](#) [65781-018](#) [65781-047](#) [65817-010LF](#)
[65817-015LF](#) [66207-023LF](#) [67016-026LF](#) [67095-007LF](#) [68631-112](#) [68645-018](#) [68648-049](#) [699319-000](#) [70.362.1628.0](#) [70-4210](#) [70-4226B](#)
[70-4853B](#) [707-5020](#) [707-5028](#) [71.350.2428.0](#) [71961-016LF](#) [733-134](#) [754199-000](#) [760-3052](#) [787-8014-00](#) [FCN-367T-T012/H](#) [80.063.4001.1](#)
[800-90-001-10-001000](#) [800-90-010-10-002000](#) [801-43-002-10-013000](#) [801-43-006-10-002000](#) [803-41-018-10-001000](#) [803-43-014-20-](#)
[001000](#)