

REV. A1	DESCRIPTION EN1008200220	DATE 2010.10.06	NAME 陳錦展	X.XX±0.15	ANGLE
				X.XX±0.05	ANGLE
				GENERAL TOLERANCE	
				2009.02.18	2009.02.18
				歐陽小強	謝瑞濤
				DRAWN BY	
				APPROVED BY	
				1 : 1	1 of 2
				mm	
				UNIT	SCALE
				SHEET	

燦達電子工業股份有限公司
JOINT TECH ELECTRONIC IND. CO., LTD.

1.00mm PITCH
180° WAFER-SMT TYPE

REV. A1

DRAW NO.: A1014WVA-S-2XNP

Dimensions		No.			
Circuit		A	B	C	D
2X08P	7.00	10.30	8.45	9.25	
2X10P	9.00	12.30	10.45	11.25	
2X15P	14.00	17.30	15.45	16.25	
2X16P	15.00	18.30	16.45	17.25	
2X20P	19.00	22.30	20.45	21.25	
2X25P	24.00	27.30	25.45	26.25	

SPECIFICATIONS
 Current Rating: 0.8A AC,DC
 Voltage Rating: 50V AC,DC
 Temperature Range: -25°C ~ +85°C
 Contact Resistance: 20mΩ Max.
 Insulation Resistance: 100MΩ Min.
 Withstanding Voltage: 250V AC/minute
 Pin Material: Phosphor Bronze
 Solder Tabs: Brass
 Material: Nylon 6T,UL94V-0
 Cap: Nylon 6T,UL94V-0,Natural(Beige)
 Color: Natural(Beige)

P/N LEGEND
 A1014 WVA-S-2XNP XXX
 ① Series No.
 ② Connector type: WVA=Vertical A Type
 ③ Mounting type: S=SMT without boss
 ④ No. of circuits
 ⑤ Option code:
 Blank=Contacts/Gold-flash and
 Solder tabs/Matte Tin-plated

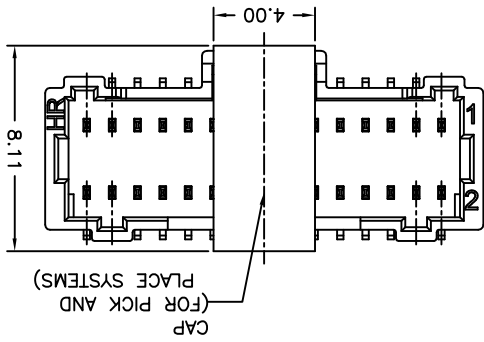
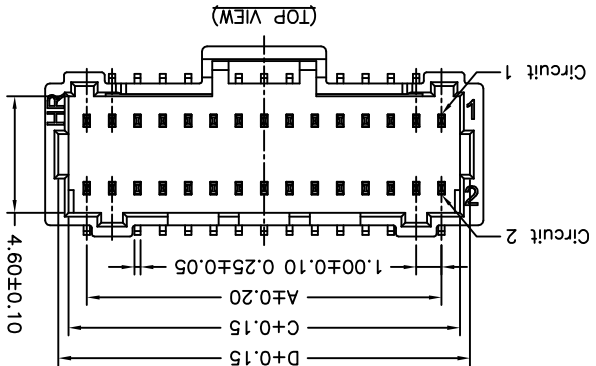
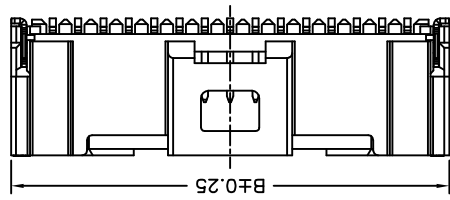
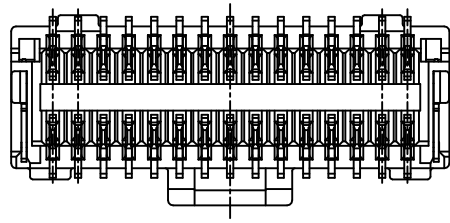
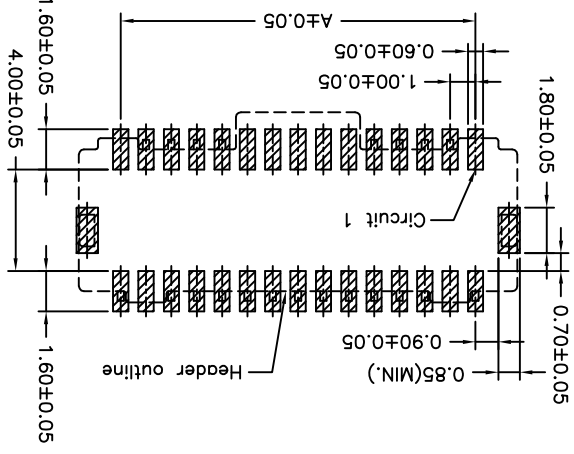
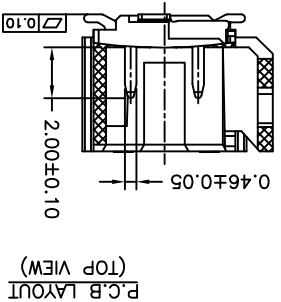
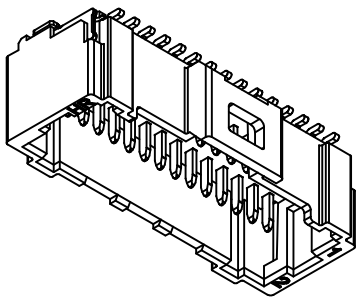
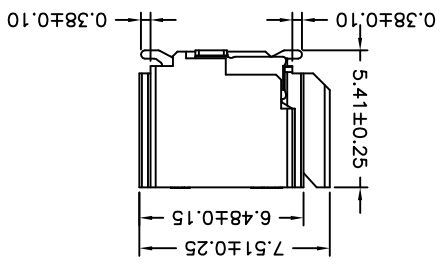
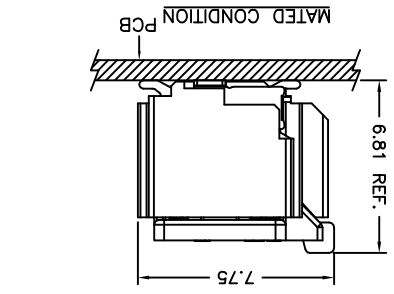

X-ON Electronics

Largest Supplier of Electrical and Electronic Components

Click to view similar products for [Headers & Wire Housings](#) category:

Click to view products by [Joint Tech](#) manufacturer:

Other Similar products are found below :

[95000-104TRLF](#) [10135584-644402LF](#) [DF62W-EP2022PCA](#) [95000-106TRLF](#) [DF62W-2022SCA](#) [DF62W-EP2022PC](#) [2203348](#) [DF62W-2022SC](#) [1084018](#) [1029039](#) [1084017](#) [802-10-012-10-002000](#) [1112640](#) [1112639](#) [891-007-9SS-BST1T](#) [000-34000](#) [0008550134](#) [0009482033](#) [0009507031](#) [57102-F02-18ULF](#) [57102-S06-03LF](#) [57202-S52-04LF](#) [PCN6-15S-2.5E](#) [0039019024](#) [58102-G61-06LF](#) [582553-1](#) [0009485154](#) [0009508121](#) [0022285053](#) [0050291907](#) [018731A](#) [LY20-4P-DT1-P1E-BR](#) [02.125.8002.8](#) [60101931](#) [60598-1 \(Cut Strip\)](#) [M1625-3R/100](#) [61062-3](#) [61082-181009](#) [CSU011177004](#) [636-1427](#) [638009-1](#) [641938-9](#) [641991-4](#) [644168-1](#) [644827-2](#) [647662-1](#) [65039-019ELF](#) [65692-001LF](#) [65781-018](#) [65781-047](#)