



P/N LEGEND

A12514	H-XP	N	0	X	NP	N	00	G	
①	②	③	④	⑤	⑥	⑦	⑧	⑨	⑩

① Series No.  
 ② Connector type: H=Housing  
 ③ No. of circuits  
 ④ N=Halogen Free  
 ⑤ Material: 0=Nylon 66-V0  
 ⑥ Color: W=White ; B=Black  
 ⑦ Plating code: NP=Non-plating  
 ⑧ Plating code: N=Non-plating  
 ⑨ Option code: 00=Standard  
 ⑩ Packing code: G=Bag

SPECIFICATIONS

Current Rating: 1A AC,DC  
 Voltage Rating: 50V AC,DC  
 Temperature Range: -25°C ~ +85°C  
 Contact Resistance: 30mΩ Max.  
 Insulation Resistance: 100MΩ Min.  
 Withstanding Voltage: 500V AC/minute

Circuit No.	Dimensions			
	A	B	C	D
02P	1.25	3.75	1.90	-
03P	2.50	5.00	3.15	-
04P	3.75	6.25	4.25	-
05P	5.00	7.50	4.25	6.75
06P	6.25	8.75	6.25	8.75
07P	7.50	10.00	6.25	8.75
08P	8.75	11.25	6.25	8.75
09P	10.00	12.50	6.25	8.75
10P	11.25	13.75	8.20	10.70
11P	12.50	15.00	8.20	10.70
12P	13.75	16.25	8.20	10.70
13P	15.00	17.50	8.20	10.70
14P	16.25	18.75	8.20	10.70
15P	17.50	20.00	8.20	10.70

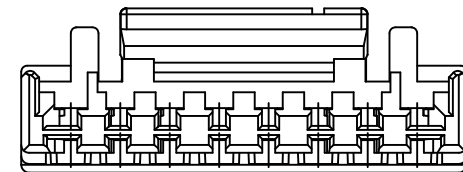
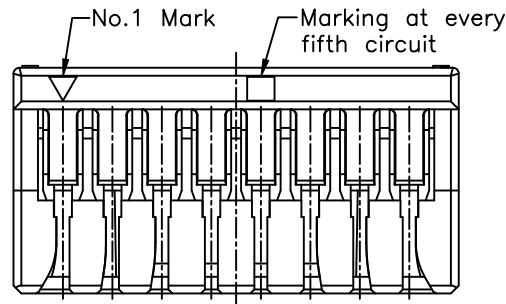
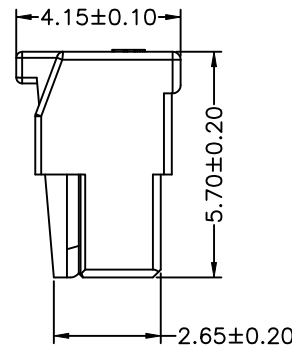
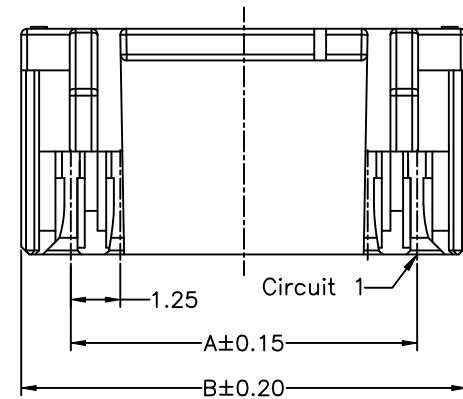
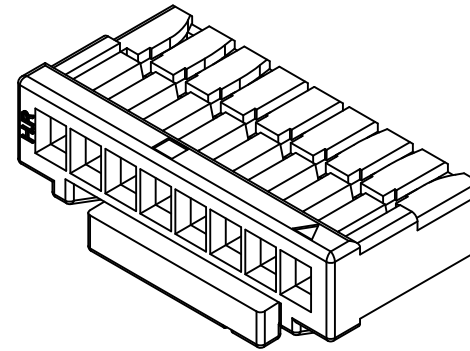
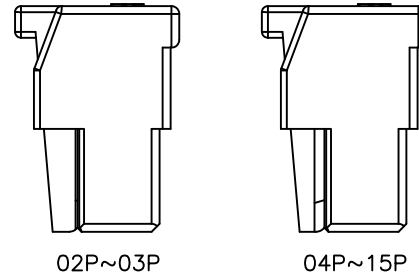
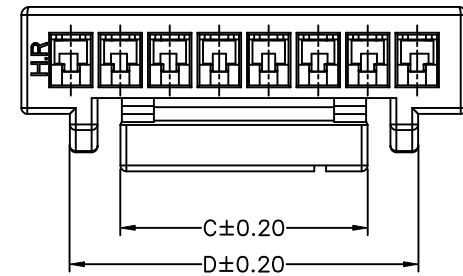

				燦達電子工業股份有限公司 JOINT TECH ELECTRONIC IND. CO., LTD.			
				UNIT	SCALE	SHEET	TITLE:
				mm	1 : 1	1 of 2	
A5	EN202206071082	2022.05.24	徐貴湖	DRAWN BY	APPROVED BY	2019.09.23	1.25mm PITCH SINGLE ROW HOUSING
A4	EN202204221030	2022.04.22	吳清				
A3	EN20210827782	2021.11.17	劉國紅	2019.09.23			
A2	EN20210730736	2021.07.30	劉國紅	GENERAL TOLERANCE			
A1	NEW RELEASE	2020.06.29	鄭小嬌	X. X±0.25	ANGLE±		
A0	NEW RELEASE	2019.11.21	焦秋蘭	X. XX±0.15			
REV.	DESCRIPTION	DATE	NAME	X. XXX±0.05			DRAW NO. : A12514H-XPXXXXXXX
							REV. A5

1 |

2 |

3 |

4 |



1 |

2 |

3 |

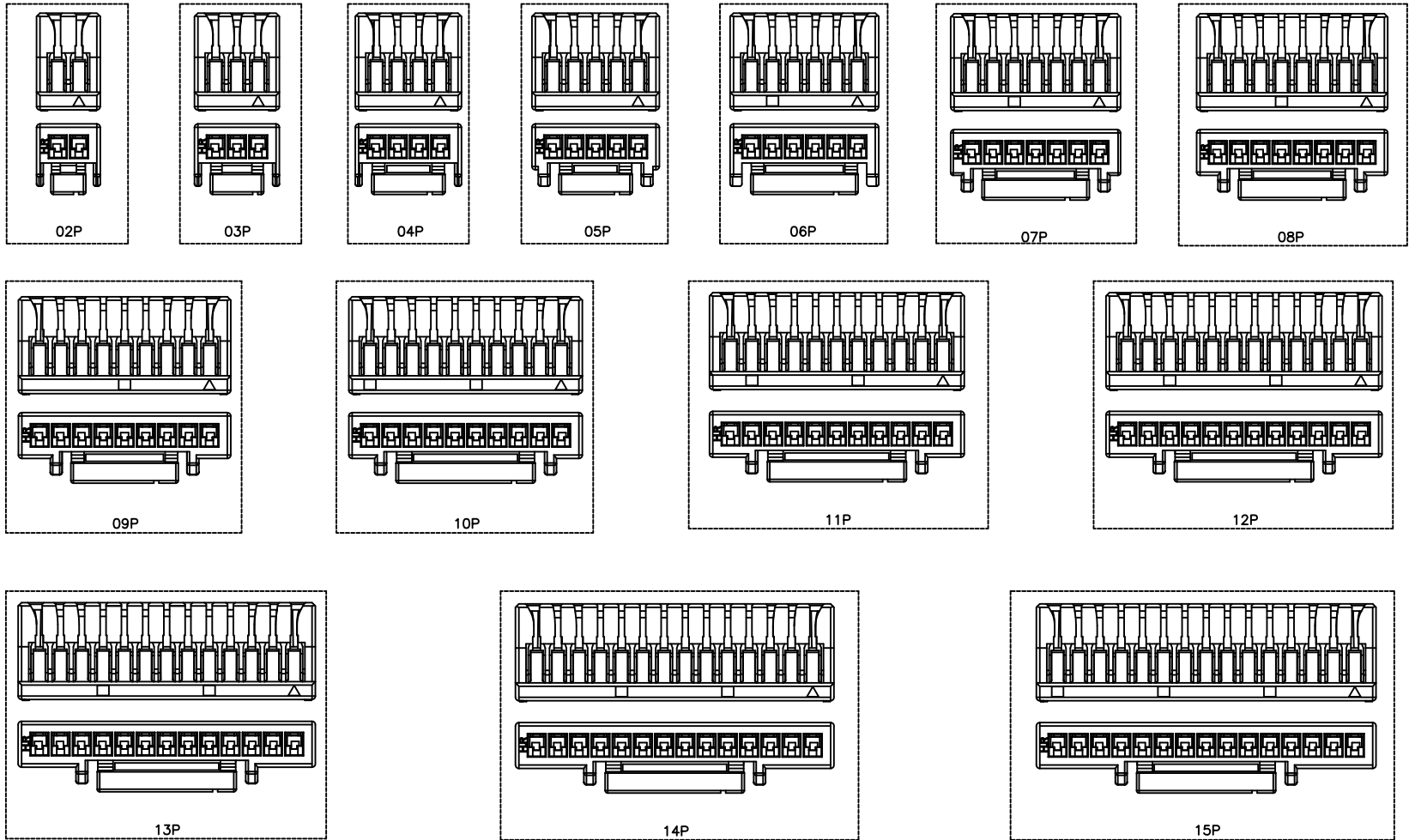
4 |



						 燦達電子工業股份有限公司 JOINT TECH ELECTRONIC IND. CO., LTD.						
						UNIT	SCALE	SHEET	TITLE:			
						mm	1 : 1	2 of 2				
A5	EN202206071082	2022.05.24	徐貴湖	DRAWN BY	APPROVED BY			1.25mm PITCH SINGLE ROW HOUSING  DRAW NO. : A12514H-XPXXXXXXX      REV. A5				
A4	EN202204221030	2022.04.22	吳清	焦秋蘭	謝瑞清							
A3	EN20210827782	2021.11.17	劉國紅	2019.09.23	2019.09.23							
A2	EN20210730736	2021.07.30	劉國紅	GENERAL TOLERANCE								
A1	NEW RELEASE	2020.06.29	鄭小嬌	X. X±0.25	ANGLE±							
A0	NEW RELEASE	2019.11.21	焦秋蘭	X. XX±0.15								
REV.	DESCRIPTION	DATE	NAME	X. XXX±0.05								

## X-ON Electronics

Largest Supplier of Electrical and Electronic Components

*Click to view similar products for [Headers & Wire Housings](#) category:*

*Click to view products by [Joint Tech](#) manufacturer:*

Other Similar products are found below :

[0015917161](#) [0022155065](#) [57102-F02-18ULF](#) [58102-G61-06LF](#) [582553-1](#) [01.001.5753.1](#) [0050291907](#) [02.125.8002.8](#) [609-3404](#) [61062-3](#)  
[CSU011177004](#) [622-0430](#) [622-3653LF](#) [63453-116](#) [636-1030](#) [636-1427](#) [636-3427](#) [636-4007](#) [641938-9](#) [65495-038](#) [65692-001LF](#) [65781-018](#)  
[65781-047](#) [65817-010LF](#) [65817-015LF](#) [67095-007LF](#) [67601157](#) [68631-112](#) [68645-018](#) [699319-000](#) [70.362.1628.0](#) [70-4210](#) [70-4226B](#) [70-](#)  
[4853B](#) [71.350.2428.0](#) [733-134](#) [733-162](#) [760-3052](#) [MHR-64-VUAL](#) [80.063.4001.1](#) [800-90-001-10-001000](#) [801-43-002-10-013000](#)  
[801-43-006-10-002000](#) [803-43-024-10-001000](#) [803-93-012-10-001000](#) [8-1437020-4](#) [819-22-004-30-001101](#) [820-22-006-30-001101](#)  
[820-22-008-30-001101](#) [821-22-002-10-001101](#)